

# THE FINISHING TOUCH

GOOD STUFF FOR SAAB  
95, 96 and SONETT

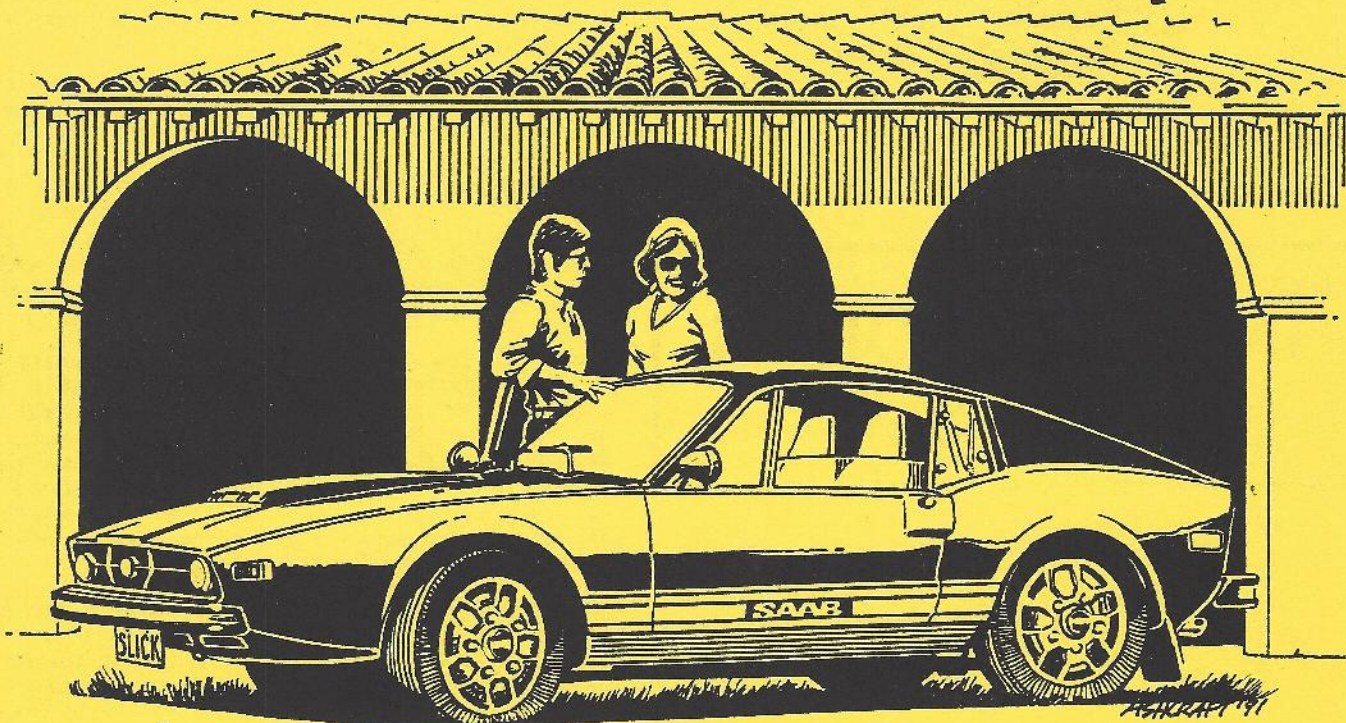

"OH, I THINK IT LOOKS  
BETTER THAN NEW!"

**AW**  
**PARTS**

CATALOG FT-1

JACK ASHCRAFT AUTOMOTIVE DESIGN

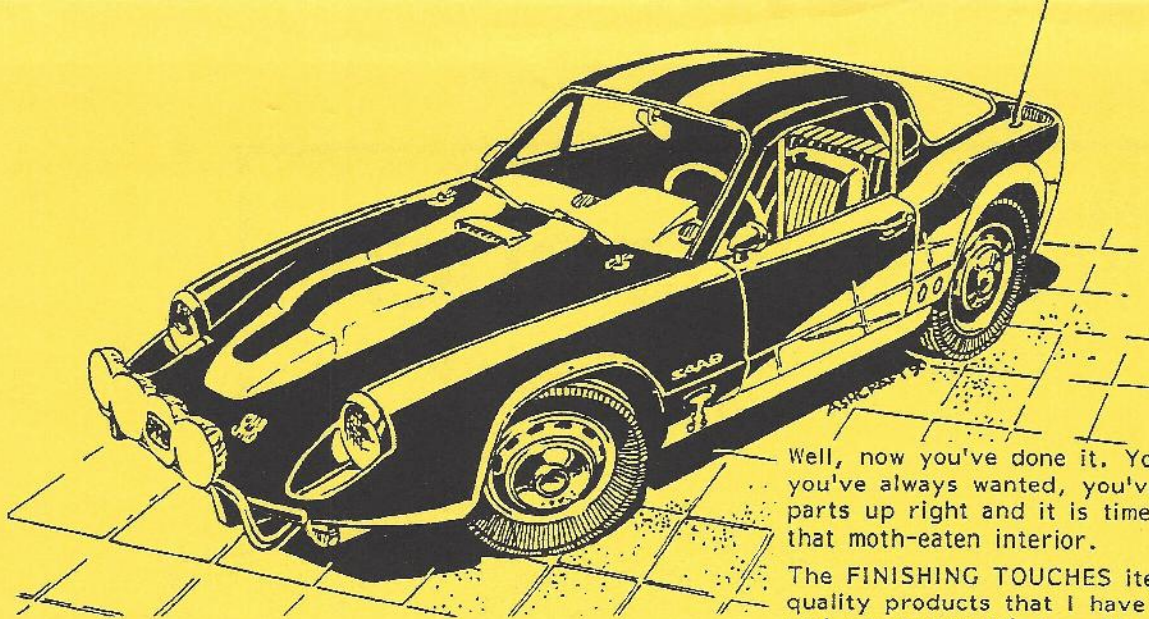

## THE FINISHING TOUCH

GOOD STUFF FOR SAAB  
95, 96 and SONETT

Well, now you've done it. You've bought the Saab you've always wanted, you've done the mechanical parts up right and it is time to start the attack on that moth-eaten interior.

The FINISHING TOUCHES items we offer are first quality products that I have used on my own cars and my customers' cars. They look good, fit very well and are very durable. The kits all come with very detailed, illustrated, step-by-step instructions and where the installation requires extra hands or special tools, these instructions tell you about it. You should be able to make the installations with a minimum of trouble. But DO read the instructions over a couple of times before you start the job.

I must tell you going in here that the upholstery kits and carpets are NOT EXACT REPLICAS of the originals. The CUSTOM parts are similar in color and style, but do not have the 1.5" vertical, molded-in stitching on, for example, the door panels and the panels on the sides and rear of the luggage area. These CUSTOM panels are smooth and actually modernize the interior considerably while retaining the flavor of the originals.

For those who do want something closer to the original, the ORIGINAL STITCH panels DO have 1.5" vertical stitching and look a lot like the original upholstery but our fabrics, vinyl and carpeting have somewhat richer colors in basically similar shades as the originals.

In all cases, the materials used are exceptionally good quality. As good, or better, than the stuff Saab used. Our kits should last for many years, given normal use and care. I think you will be very pleased with them.

We do offer some special tools and some products for cleaning and protection of your new upholstery. These cleaning and protecting products are commercial quality and are superior to most anything you can find in a store. The tools make short work of a hard job (like the scraper tool for cleaning the old foam off the Sonett roof when you put in a headliner) and nothing else I have found even comes close to them in operation. Each of these products is described in the catalog.

Speaking of descriptions, each kit is described in detail in this catalog, but if you have further questions, don't hesitate to drop me a line or give me a call. Our office hours are 9AM-5PM Monday thru Saturday, Pacific time. Also, don't be afraid to leave a message with my mechanical secretary machine if you don't get a real human to answer your call. I may have both hands under a Saab and can't let go!

Good luck with your little Swede!

*Jack  
Ashcraft*

# DRESS-UP ITEMS

## 4004A CHROME PLATED V4 VALVE COVERS (2)

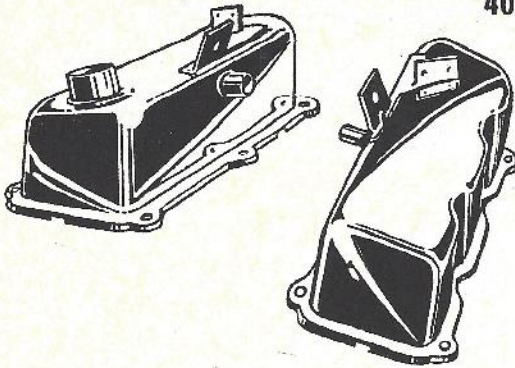

Show off a little in the engine bay! These triple chrome plated valve covers really brighten things up in there! One of the best things about chrome is that it is easy to clean and doesn't discolor and peel like paint. These covers will make you grin every time you look in the engine bay! Sold on exchange basis. Gaskets extra.

## 4004B TWO VALVE COVER GASKETS FOR KIT 4004A.

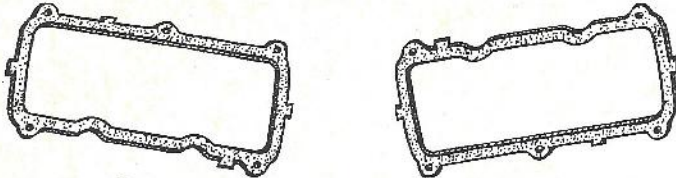

## 4004 CHROME VALVE COVERS WITH ANTI-LEAK KIT

The same triple chrome plated covers as 4004A but with a very useful hold-down clamp set that really cuts leaks! These clamps are also chrome plated. The kit comes with 10 metric studs, 10 washers, 10 lock washers and 10 metric nuts. These replace the stock bolts to hold down the covers. You put in the studs with a drop of thread lock, install the gaskets in the new covers, put the new covers on the engine, shine 'em up a little and smile a lot. Two gaskets included. Covers sold on exchange basis.

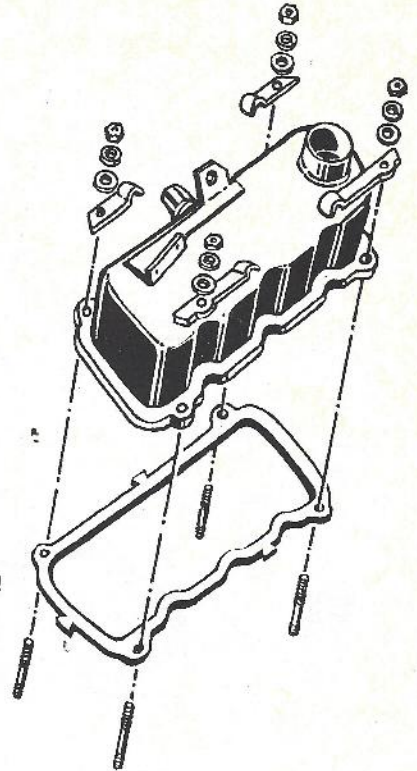

## 4049 CHROME PLATED, REBUILT V4 ENGINE DIP STICK

Most V4 dipsticks need to be repaired. The originals were sort of staked together at the handle and that jury rig soon came loose. From that time on, you could tell there was oil in the engine but never exactly how much.

These dip sticks have been jigged for proper depth, straightened, the cap WELDED in place and the top section chrome plated. They look great, work great and add a subtle custom touch to the engine bay.

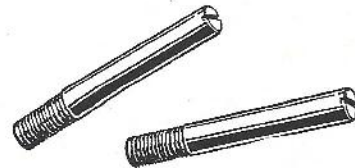
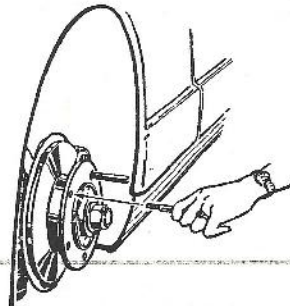
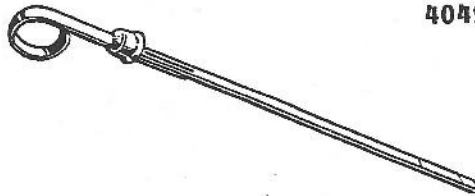

## 4017 CHROME PLATED MAG WHEEL MOUNTING STUDS (2)

These studs really take the fight out of changing a mag wheel on a Sonett. You just thread in the 2 studs with your fingers, set the wheel onto the studs and push it in. Then screw in three of the regular lug bolts, unscrew the 2 chrome studs, screw in the last 2 lug bolts, let the car down, tighten the lug bolts, and you're done. No sitting on the ground, no ruined clothes and minimal swearing. And...they look great!

## 4018 ZINC PLATED MAG WHEEL MOUNTING STUDS (2)

Same useful mounting studs as 4017 but zinc (not chrome) plated.

# WEATHERSTRIP KITS

## 4026 SONETT III GLASS HATCH WEATHERSTRIP KIT

Kit contains weatherstrip, silicone sealer and complete instructions including a BONUS extra: How to adjust the latch for the rear glass to minimize the chance of breakage. Easy to install with our fully illustrated instructions. No more water leaks! A MUST when you put in that new upholstery & carpet back there!

## 4043 SONETT HEATER AIR INTAKE WEATHERSTRIP

Keep engine bay fumes and unwanted noise out of the cabin! This often overlooked piece of weatherstrip gets hard & cracked and no longer seals properly--heat and old age have taken their toll.

Our replacement part seals properly and insures that only outside air gets into the cabin. Easy to replace.

Fits all Sonetts, 1967 - 1974.

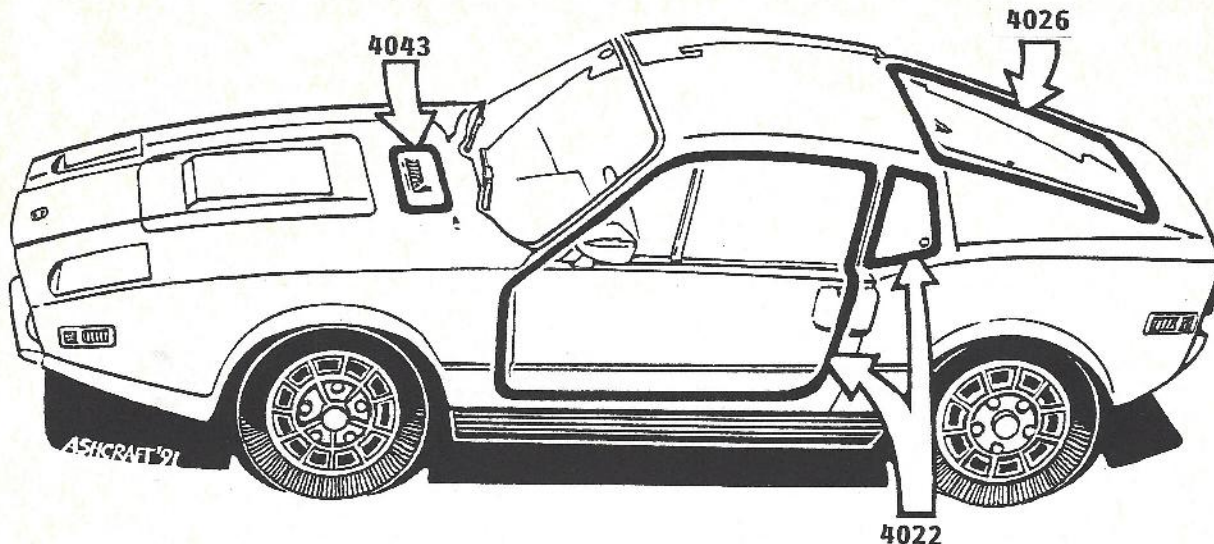

## 4022 SONETT III DOOR & SIDE VENT WINDOW WEATHERSTRIP KIT

Miraculous things often happen when this kit is installed! The car suddenly loses a lot of wind noise because the seal is better than the original and the rain & snow stays out!

Kit contains pre-cut weatherstrip material for both doors and both side vent windows. Easy to install with simple tools. Complete illustrated instructions included! PLUS a bonus extra: How to adjust the doors for a proper fit with the new weatherstrip.

## 4021 SONETT II & V4 DOOR WEATHERSTRIP

Complete illustrated instructions come with this easy to install kit for the doors of the first series Sonetts. Keep out rain, snow, dust and a lot of wind noise with the new weatherstrip in this kit! Bonus instructions included for door adjustment! Easy to install with simple tools.

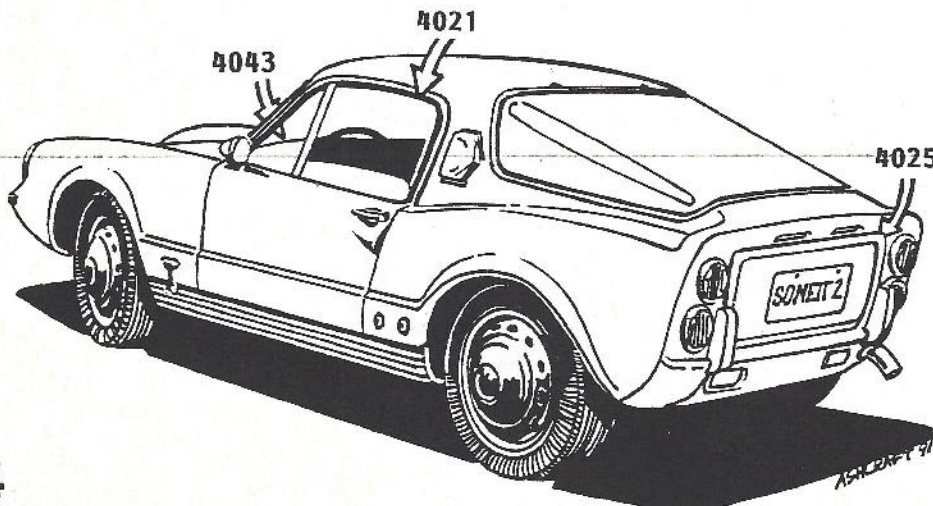

## 4025 SONETT II & V4 LUGGAGE DOOR WEATHERSTRIP KIT

EXHAUST FUMES! AK! They always let you know when the seal on this door is shot! Replace the old, shrunken seals with this new one. Kit includes weatherstrip, silicone sealer and complete illustrated instructions. Quiets the car and cuts out the dangerous exhaust fumes. A cinch to install!

# CARPET & UPHOLSTERY--SONETT III

## 4070 HEADLINER KIT, SONETT III

This is a very nice cloth headliner. The kit includes the pattern-cut headliner, new trim panels for the area above each door, a can of spray adhesive, upholstery screws & washers and COMPLETE ILLUSTRATED INSTRUCTIONS.

The kit is engineered so that you can install it by yourself, except for the actual steps of putting the headliner up onto the roof. Two people for that act, please! The old headliner, most of which has fallen down around your ears anyhow must be cut out and removed. Then the top must be scraped clean. The VERY, VERY best tool for that job is our #4059 Razor Knife. This thing will shorten a 3 hour job to 15 minutes, it's that good! I can't recommend it enough! This foam-backed headliner, installed according to the very complete illustrated instructions, looks like a Cal custom job when it's in! Beautiful! Available in either Saddle or Light Gray cloth material.

Available in either Saddle Tan or Light Gray cloth material.

## 4059

RAZOR KNIFE--Folding, Lock-in-Position

This baby works better to scrape the old glue, foam and crud off the roof of a Sonett than ANY other tool I've ever found. Uses regular single edge razor blades. Closes in "safe" position for storage. Opens to 3 locked positions for use. Angles JUST RIGHT for the Sonett roof. Wonderful tool and inexpensive, too! Treat yourself to the RIGHT TOOL FOR THE JOB! Just DO it!

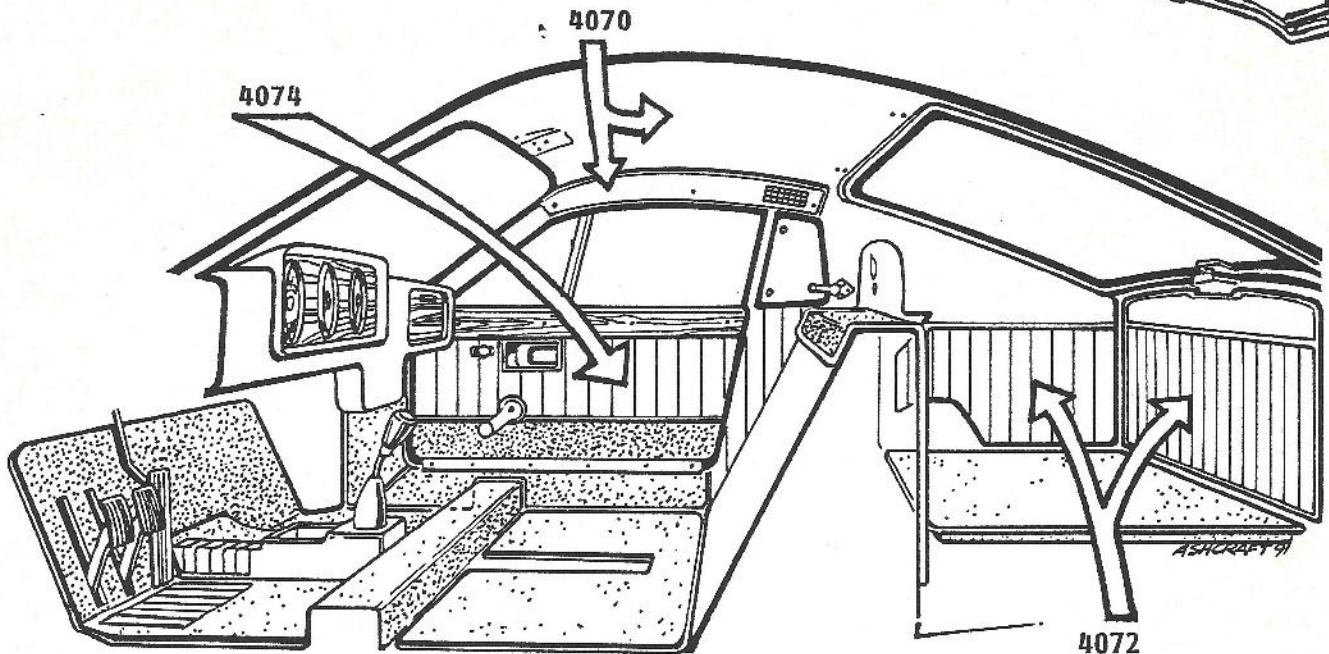
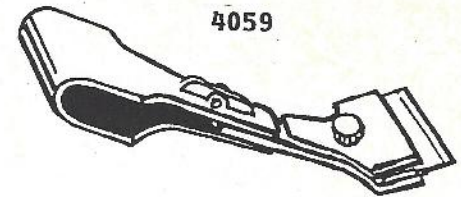

## 4072 SONETT III LUGGAGE AREA 3-PIECE KIT

This kit has two side and one rear piece. All three upholstery pieces are mounted on NEW upholstery board. All necessary upholstery screws are included. You will need to mount the aluminum angle pieces off your old side panels onto the new side panels with the upholstery screws provided. Puts the final touch to the rear compartment to make it look like new! Easy to install with our complete, illustrated instructions.

Available in Custom (unstitched vinyl side panels & carpeted rear panel. Carpet is Saddle Tan or Black)

Original Stitch (vinyl on all 3 panels - stitched on lower portions similar to the original Saab upholstery. Saddle Tan or Black)

## 4074

### SONETT III DOOR PANELS

Pattern cut door upholstery on new backing board with carpeted lower area. Replaces worn, damaged, warped or shrunken panels on both doors. Available in Saddle Tan or Black, Custom or Original Stitch. Also specify Early or Late car (the door handle type is what we really need to know so we send you the right panel. See door handle illustration).

We include all new upholstery panel attachment clips. Just clip them in place and put the new panels on the doors. Beautiful! Complete, illustrated instructions included.

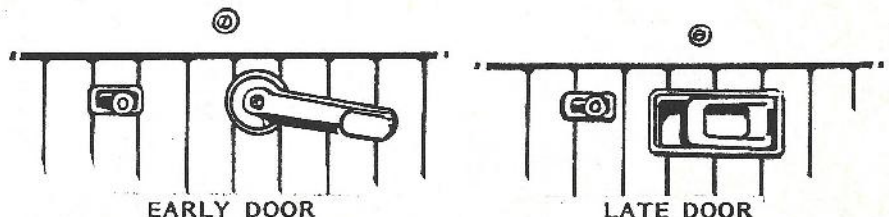

### 4071 SONETT III BULKHEAD & LUGGAGE FLOOR CARPET KIT

This is a 2-piece set. One piece fits the luggage floor and has a fat sound deadening pad attached to it. The other piece caps the fuel tank bulkhead behind the seats, and extends down into the spare tire well. Spray adhesive for attaching this piece to the bulkhead is included. All exposed edges are bound in matching vinyl trim. Bulkhead piece fits round the roll bar and glass hatch release lever. This set adds a smart, custom look to the rear area, helps deaden sound and covers upholstery that is usually badly sun-damaged.

Available in Saddle Tan or Black

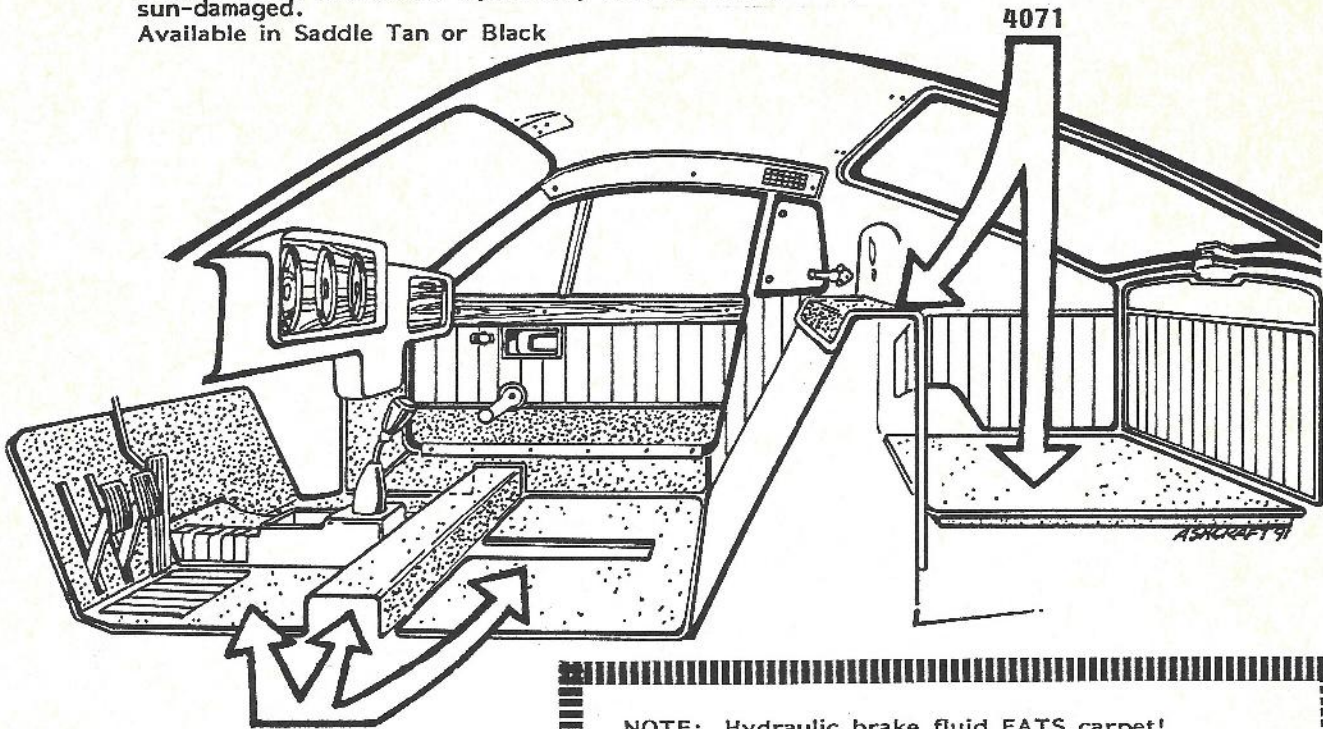

4073

### SONETT III ELEVEN-PIECE CABIN CARPET KIT

Top quality automotive carpet pattern cut to assure correct fit. All exposed edges are bound in matching vinyl trim. Carpet has heel pads bound in on driver's floor piece (behind pedals) and on the carpeted shift lever cover. Commercial grade upholstery and trim adhesive is included for the carpet pieces to be glued down. Sound proofing blanket is attached to the back of all but the glued-down pieces. This is a beautiful set that is easy to install with our COMPLETE, ILLUSTRATED instructions.

Available in Saddle Tan or Black with matching heel pads.



**NOTE:** Hydraulic brake fluid EATS carpet! Once you have the old carpet out, remove the screws holding the toe panel in place behind the clutch & brake pedal and inspect for leaks. Small leaks will be found at the push rods going into the clutch & brake master cylinders. Major leaks will show a LOT of brake fluid on the floor. Replace bad cylinders. Thoroughly clean up the brake fluid on the floor. Keep brake fluid off any painted surface for it is a wonderful paint remover! Use solvent (mineral spirits) on a cloth for final clean up of brake fluid. Wipe dry. Only then should you put down new carpet!

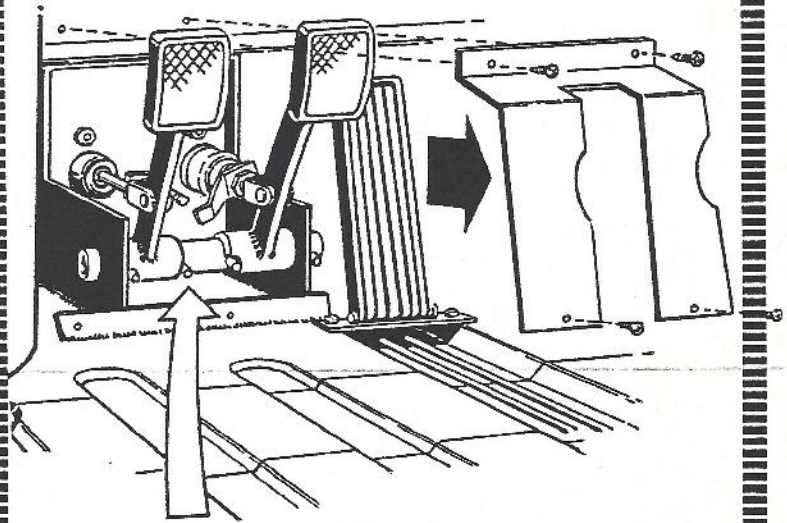

CHECK IN HERE FOR HYDRAULIC BRAKE FLUID LEAKAGES FROM THE CLUTCH MASTER CYLINDER (LEFT) OR THE BRAKE MASTER CYLINDER (RIGHT).

# CARPET & UPHOLSTERY--SONETT II & V4

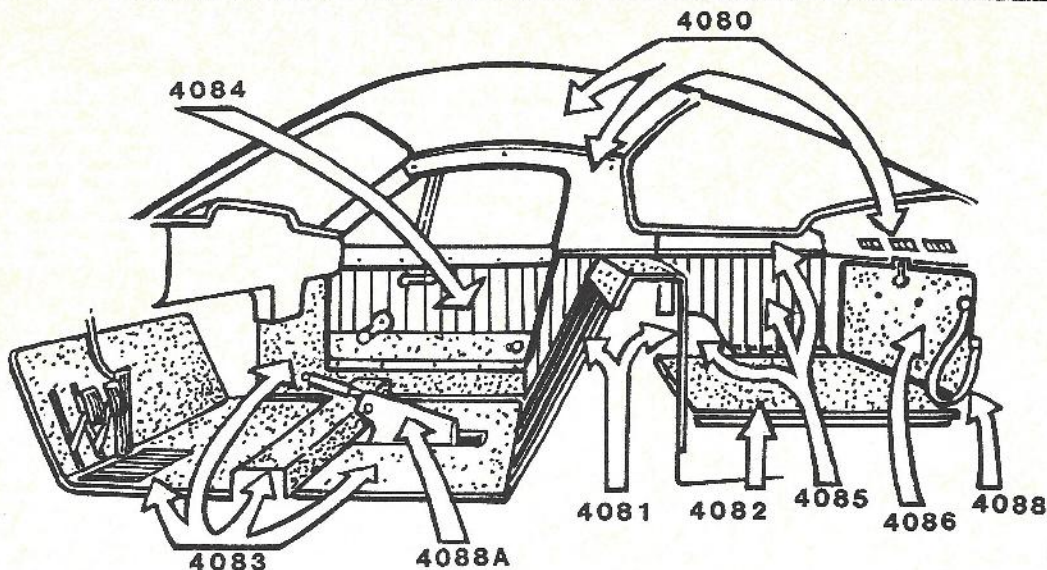

## 4080

### HEADLINER KIT, SONETT II, V4

This is a high quality headliner, in light gray cloth with a foam backing. The kit includes the pattern-cut headliner, the side trim pieces above & immediately behind each door, spray adhesive, new screws and washers and COMPLETE ILLUSTRATED INSTRUCTIONS. The kit is engineered so you can install it yourself--with a friend's help when you hang the actual headliner, please--and NO, you DO NOT remove the windshield or heaven forbid, the rear window! I strongly recommend the # 4059 Razor Knife, which turns 3 hours of putty knife scraping and swearing into a 15 minute breeze when you clean the foam residue off the top of the car! The headliner alone will make you think you have a new Sonett--these are NICE!

## 4081

### BULKHEAD COVER

This is available in a number of ways. First as a cap as shown, in either dark gray or black carpet. Next as a full carpeted cover over the whole bulkhead, front and rear, in either dark gray or black. Finally as a stitched vinyl cover over the whole bulkhead, in smooth black. In any of these covers, exposed edges are bound in matching vinyl. Replace that sun-damaged cover now!

## 4082

### LUGGAGE FLOOR CARPET

This carpet matches the cabin carpet set, is similar to original, which was a dark gray. Also available in a black carpet. Either carpet has the edges bound in black vinyl and has a thick sound deadening pad attached to the underside. A touch of luxury!

## 4083

### CABIN CARPET SET

Top quality automotive carpet, pattern cut to assure correct fit. All exposed edges bound with black vinyl. Black heel pad is bound into driver's side as shown. Sound deadening blanket is attached to flip side of all carpet that is not glued down. Spray adhesive and instructions included. Available in similar-to-original dark gray or black colors. A beautiful set, easy to install.

## 4084

### DOOR PANELS

Pattern cut door upholstery on new backing board with carpeted lower area. Replace your old bent-out-shape panels with these excellent new items! New plastic vapor barrier sheets, snap-in clips and full instructions included. In black nubby vinyl, stitched in a pattern similar to original. Available in dark gray or black. These are beautifully done!

4080

RAZOR KNIFE, lock-in-position, folding.

Cleaning the roof of the old headliner is one mean job and this tool makes very short work of it. It is the VERY BEST TOOL I have ever found for this job! You won't be sorry you bought this baby, I guarantee!

## 4059

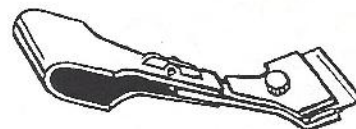

## 4085

### LUGGAGE AREA SIDE PIECES

Four piece set includes small carpeted pieces over the rear fender wells, and the stitched nubby vinyl side pieces with a bit of the headliner material at the top. Side pieces mounted on new board with sound deadening blanket on the back. Installation instructions included. Available in dark gray or black.

## 4086

### REAR DOOR CARPET

Quality automotive carpet with black vinyl edge binding to match your new carpet set up front! Available in a similar-to-original dark gray or in black. Nice! Spray adhesive included.



NOTE: BRAKE FLUID RUINS  
NEW CARPET! SEE  
NOTE ON SONETT 3  
CABIN CARPET PAGE!



## 4088

### LUGGAGE DOOR SUPPORT STRAP

Thick black leather strap replaces old, broken, torn, worn, dog-chewed, no-good, wasted strap on your little jewel. Adds a final touch to the luggage area! Fits right where the original strap fit. NEAT!

## 4088A

### EMERGENCY BRAKE COVER

Another finishing touch, this time to the front cabin area. Pattern cut from thick automotive vinyl, edge-bound and held in place with an upholsterers snap instead of that silly push-thru device, these smart brake lever covers are available in dark gray, black or saddle and fit ALL SONETT AND 95 AND 96s!

# MORE INTERIOR STUFF

## SEAT INSERT PATTERNS

ORIGINAL CAL CUSTOM

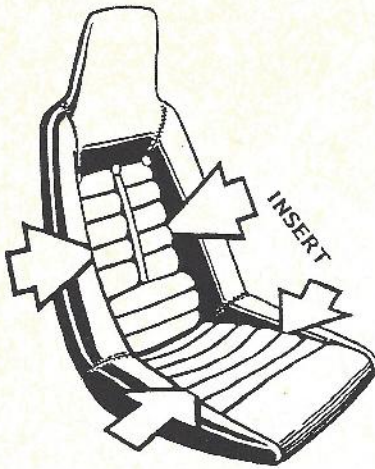

### 4075 SONETT III SEAT UPHOLSTERY INSERTS

Get beautiful seat insert replacements for both seats. All new upholstery, foam, vinyl, hardware and spray adhesive as well as complete, illustrated, step-by-step instructions. New moveable lumbar pads are included. Available for Sonett III in Saddle Tan color cloth only, in Original or Cal Custom (see above). Note that Original is not exactly the same as Saab used

NOTE: THESE KITS ARE FOR SEAT INSERTS ONLY. OUTER VINYL PARTS OF THE SEATS ARE NOT INCLUDED. OFTEN, AFTER THE INSERT IS REMOVED, YOU CAN CLEAN THE VINYL, AND IF IT IS NOT TORN OR OTHERWISE DAMAGED, SPRAY IT WITH A GOOD VINYL SPRAY, FOR A "NEARLY NEW" LOOK!

### 4087 SONETT II & V4 SEAT UPHOLSTERY INSERTS

High quality nubby stitched vinyl inserts, very similar to the original Saab material. In black color. Or, if you are not a purist and want something cooler in summer and warmer in winter try our Cal Custom medium gray cloth inserts (see above) that really feel good and look very rich against the black vinyl outer portions of the seats. You get all new upholstery material, new foam, hardware and a can of spray adhesive as well as our illustrated instructions. The low back seats were not factory equipped with moveable lumbar pads.

NOTE:

IT IS POSSIBLE TO FIND SEATS FROM MOST ANY YEAR SONETT IN YOUR CAR UNLESS YOU ARE THE ORIGINAL OWNER, BECAUSE THEY ARE SO EASILY INTERCHANGED. THE MOST COMMON SWAP IS A HIGH BACKED SEAT INTO A SONETT II OR V4 THAT ORIGINALLY HAD LOW BACK SEATS. ACCORDING TO THE SAAB PARTS MANUAL, LOW BACK BLACK VINYL SEATS WERE USED UP TO CHASSIS NUMBER 1228. FROM CHASSIS 1229 TO 1968, THE END OF THE V4 MODEL RUN, HIGH BACK BLACK VINYL SEATS WERE USED, SOME WITH MOVEABLE LUMBAR SUPPORT PADS. ALL SONETT III HAD HIGH BACK CLOTH INSERT SEATS WITH MOVEABLE LUMBAR PADS. A FEW 73-74 CARS HAD OPTIONAL LEATHER SEAT UPHOLSTERY. THE LAST OF THE 74 SEATS HAD SEAT BELT BUZZER STRIP SWITCHES BUILT INTO THE SEAT PORTION. AT THIS TIME WE CANNOT SUPPLY THE LEATHER INSERTS, NOR CAN WE INSTALL THE SEAT BELT BUZZER STRIP SWITCH. IF YOU HAVE A QUESTION ABOUT YOUR SEATS, THE CORRECT UPHOLSTERY OR THE CORRECT PRICE, WRITE, CALL, OR FAX (USE SAME TEL NO.) US AND WE WILL HELP YOU GET THE CORRECT UPHOLSTERY FOR YOUR SEATS!

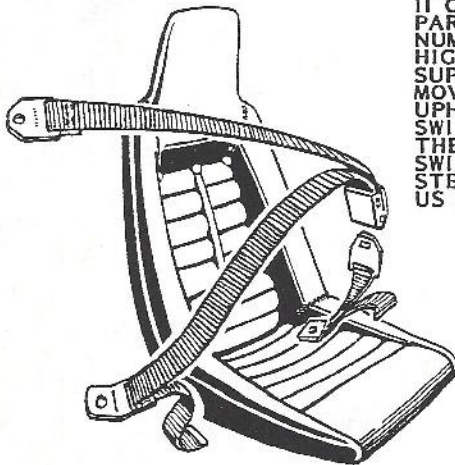

### 4027 3 POINT SAFETY HARNESS SET FOR 95,96 AND ALL SONETTS

Nylon 5000 pound NTSB Certified Safety Harness. Replaces stiff, worn, damaged harnesses easily and quickly. Set includes two complete harnesses (one shown). These harnesses do not have retractors.

DON'T BET YOUR LIFE ON OLD, WORN SEATBELTS!

### 4040 SONETT III TRANSMISSION SAVER KIT

Modern cars spring load the shift lever to the 3rd/4th quadrant as shown above. The reasoning is that if a wrong gear is accidentally selected and the clutch is let out, at say, 60 miles an hour, no harm can be done if the car is in 3rd or 4th. But in 2nd...either the transmission or the engine or at the very least the clutch is going to blow sky high!

On a Sonett III, a right turn downshift from 3rd to 2nd tends to push the driver towards the door, which tends to pull the shifter farther left than usual, then BACK... KRUNCH!...that used to be REVERSE! This spring kit goes a long way towards preventing both disasters just described. It's cheap, easy to install and great for your peace of mind. Complete, illustrated instructions are included, of course.

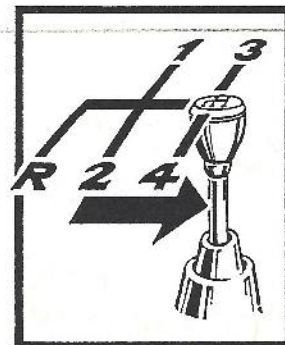



## 4047 SONETT TRANSAXLE NOISE DEADENER

The tail of the transaxle is mounted in a flexible mount that extends into the cabin just under the toe board. It transmits noise into the cabin like crazy. Saab installed a cover with some fiberglass stuffed into it to deaden that noise a bit. Our aluminum cover has a LOT of sound deadener in it, taps into place easily and does a good job of cutting gearbox noise.

TWO DENSITIES OF INSULATION INSIDE STURDY ALUMINUM CAN PROVIDE BARRIER FOR NOISES FROM TRANSAXLE TRANSMITTED THRU REAR MOUNT INTO CAR. REPLACES SAAB PART NUMBER 7087380 WHICH IS NO LONGER SUPPLIED.

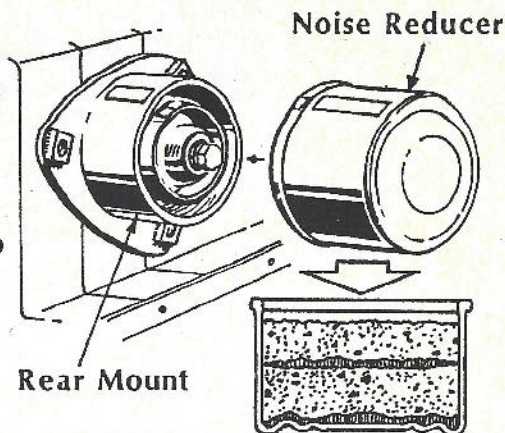

## 95/96 GOODIES

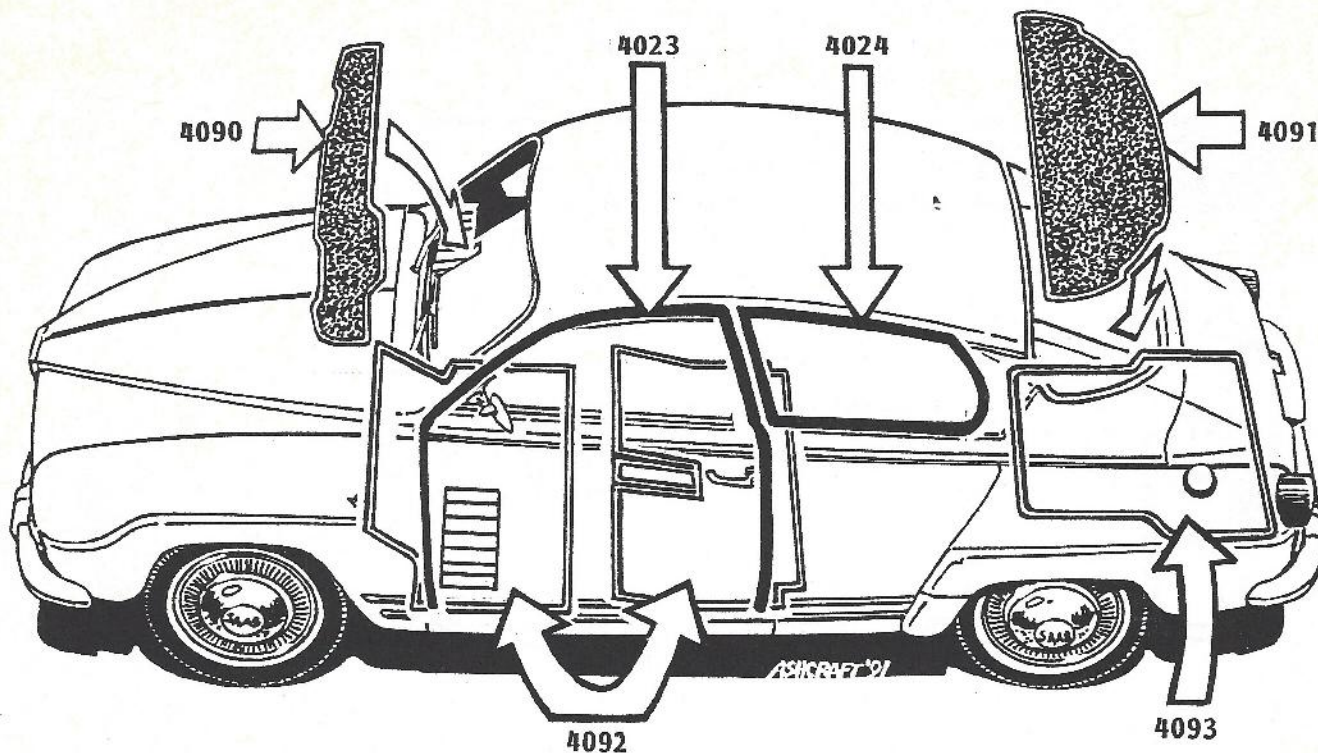

### 4090 SAAB 95/96 (ALL YEARS) DASH TOP COVER KIT

You say the top of your dashboard looks like Iraq after a B-52 strike? Fear not! The magic dash top cover is here! This black carpeted pad covers those bomb craters and looks just GREAT! Made of carpet woven just for this purpose, these pads conform to the dash but do not interfere with the defroster operation. Of course, our easy-to-install instructions are included. And of course, the edges of the dash top cover are all bound in black vinyl. Give your Saab a real dashboard beauty treatment!

### 4091 SAAB 96 (ALL YEARS) HAT SHELF COVER KIT

You didn't know that was a HAT shelf back there? Well, that's what they called it when men wore hats and rode in cars tall enough to accommodate the things! And on Saab 96's they tend to look really BA-A-AD! Our black pad is made from the same special carpet material as the dash pad, is also bound with the black vinyl. You can spray it down permanently with spray adhesive or put it in so it can be removed using tape. You can also lay it right over speakers because the material is porous and will not block sound. The flow thru air vent holes in the hat panel are not blocked by the pad. It looks really great in a 96! Even if you don't have a hat!

### 4092 CABIN CARPET SET (Saab 95/96, 1961-71 with flat front floor)

Fine quality automotive carpeting with heavy sound deadening pad attached. Heel pad stitched in on front carpet on the driver's side. Edges are bound with matching vinyl trim. Pattern cut to assure a proper fit. These carpets look good, feel good and quiet down the car. Plus they will wear well! Black carpet, available with either black or gray heel pad.

BUY  
ALL FOUR  
ITEMS--4090,  
4091, 4092 &  
4093--AND  
SAVE! SEE  
PRICE  
LIST,  
NO. 4094

**4093. SAAB 96 TRUNK FLOOR CARPET**

Get rid of that old army blanket or your kid brother's old sleeping bag from 1969! Add some REAL CLASS to the operation with MATCHING carpet for the floor area of your trunk. It's the same quality automotive carpet as the interior carpet with the edges bound in matching vinyl trim. Pattern cut to assure a good fit. Heavy pad is attached to the underside to act as a noise deadener. You'll be adding a practical yet custom touch to your baby. Nice! Now about that old, ratty luggage you got in 1957 with Blue Chip Stamps.....

**4023 95/96 DOOR WEATHERSTRIP KIT**

Cut the wind noise, cut the leaks, make the car tight once again! Kit contains precut weatherstrip materials for both doors and includes complete, illustrated installation instructions. Easy to install!

**4024 96 REAR WINDOW WEATHERSTRIP KIT**

Replace that old, shrunken weatherstrip that no longer keeps out noise or weather! Kit includes weatherstrip material for both rear side windows. Illustrated instructions show how to do it step-by-step. Makes the car like-new snug again.



**4067**

Spot remover for carpet and most cloth. Especially good for velvets, velours and pile type fabrics. It is an industrial powder type cleaner-- you just sprinkle it on, brush it into the spot lightly and then stand back! This is the best spot remover I've ever seen! Won't hurt the material, either. 8 oz can.

**OTHER GOODIES**



**4068**

**VINYL UPHOLSTERY CLEANER**

It's a jungle out there, especially in the automotive vinyl cleaner section of your favorite auto store... This stuff just seems to work BETTER than most others. It is a commercial grade cleaner that cleans well but won't damage the color of the vinyl. GOOD STUFF! 15 oz aerosol can.

**4069**

**VINYL PROTECTOR**

NO NEED to mention the name of the leading brand, but this one does a better job and WON'T leave the surface SLICK as a... Well, you know that silmey feeling! It also DRIES, so dust & crud don't stick to it. It makes the surface look new but NOT artificially shiny. And it keeps the surface of the vinyl looking new a long time. A superior product. Try it, you'll like it! 16 oz plastic squeeze bottle.



**PAINT INFO:**

THE FINISHING ISN'T FINISHED UNTIL THE FINISH IS FINISHED. MARTIN SENOUR PAINTS ARE AVAILABLE JUST ABOUT ANYWHERE AND HERE IS A LIST OF THEIR PAINT CODES FOR EARLY SAABS. YOU CAN GET A PINT OR A GALLON OR WHATEVER YOU NEED FOR YOUR SAAB.

**PAINT COLORS: SAAB TO MARTIN SENOUR**

SAAB CODE	SAAB COLOR	YEAR	M/S CODE	GY2	PEARL GRAY	59-67	20323
B4	MIDNIGHT BLUE	63-68	20629	GY4	CHARCOAL	66-68	21107
B5	GLACIER BLUE	63-68	20631	RB1	SILVER MINK POLY	71	21442
B6	HUSSAR BLUE	67-70	21104	R1	RED	70-72	21466
B7	MIDDLE BLUE	70-72	21445	RB2B	BURGUNDY RED	72	21597
B8H	CAROLINA BLUE	73-75	21880	R2	TREADOR RED	59-74	20626
GN4	CERAMIC GREEN	63-67	20630	4022	BAJA RED	72-73	21884
GN5	OLIVE GREEN	66-68	21106	W1	POLAR WHITE	61-64	20627
GN6	SEA GREEN	69-70	21163	Y5L	SILVERSAND	67-70	21109
GN7	TYROL GREEN	71-72	21443	Y6L	SAVANNA BEIGE	70-71	21441
GN8	VERONA GREEN	72-73	21599	Y1	YELLOW	67-72	21467
1117	AVOCADO GREEN	72	21677	Y4	YELLOW	66-68	21108
				Y8	AMBER YELLOW	72-73	21881
				Y9	BRILLIANT YELLOW	73	21881
				---	ORANGE	72	21678
				---	BLUE	72	21679

# SPECIAL BOOKS FOR YOUR SHOP OR LIBRARY!

SOME PRICES SHOWN ARE USA DELIVERY ONLY. WRITE FOR CANADIAN OR OVERSEAS DELIVERY PRICES.



4055--THE FAST V4--THE How-To book on building a hi-performance Saab V4 engine. Covers cams, Webers, balancing, modified heads, exhaust, oiling system, cooling system, valve train, intake manifolds, and much more! Also includes catalog of hi-performance V4 parts and master price list! A MUST-HAVE book if you are building up a V4 Saab engine for street or track!

\$8.00 USA

4053--STARTER & ALTERNATOR OVERHAUL--How-To, Step-By-Step rebuild procedures for Saab units from 2-stroke to turbo. Goes beyond the shop manual in language for the home mechanic! Has specs, tips, many drawings. Save several times the cost of the book rebuilding just one unit!

\$20.00 USA

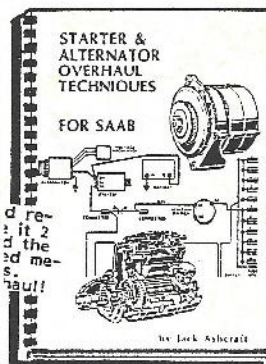

4052--SAAB ELECTRICS--How-to book for novice or expert! Starts with basics, explains test meters, relays, switches, trouble-shooting, and basic Saab circuitry. Then takes you thru major circuits for 95/96, Sonett, 99, and on thru 900 turbo. Fix just one problem and you'll save the price of the book, or more!

\$40.00 USA

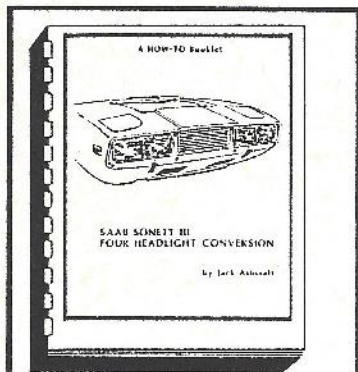

4054--SONETT III LIGHT CONVERSION BOOK

This book shows how-to-do-it for those interested in removing the pop-up lights and replacing them with 4 quartz halogen rectangular lights in the grille area of the Sonett III. The whole procedure is shown--with many illustrations--in a step-by-step fashion that is easy to follow. The job can be done by any Sonett III owner with simple shop tools. A MUST HAVE book for your personal Saab library!

\$12 Postpaid, USA, Canada

\$15 Postpaid, Overseas



4066--WEBER 34 ICH Carburetor In The Saab V4--How-To-Do-It book covers jetting, fitting the air cleaner, the PCV valve, the throttle linkage, coolant hoses, the manual choke and MORE! Save LOTS of grief, time & mistakes with this book!

\$10.00 USA

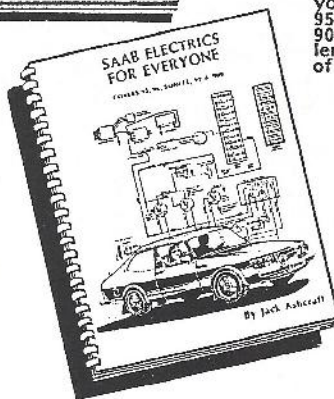

4051--SONETT SOURCES--A big parts interchange manual for all V4 powered Saabs, not just Sonetts. Hundreds of cross-reference part numbers for engine, transaxle, chassis, electrics, etc. Many illustrations. Tables for specs, torques, tools, tune-up and many how-to tips. Find the parts you need for your V4 in this heavily researched parts book!

\$15.00 USA

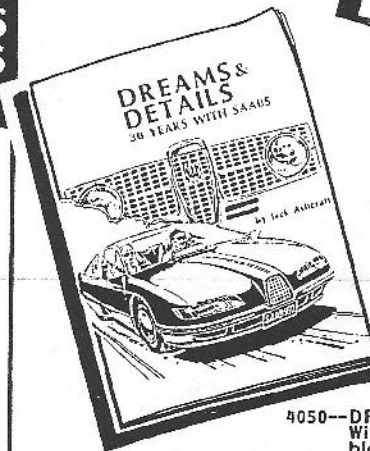

4050--DREAMS & DETAILS, 30 Years With Saabs--A neat coffee table book with Jack Ashcraft's detailed drawings on how Saab might have done it--design-wise--for the last 30 years. See a 96 pickup, sports & rally cars, a Tatra-esque 99, some slick Sonett designs, plus future design suggestions for Saabs thru the year 2000! Great book for the Saab nut!

\$24.00 USA

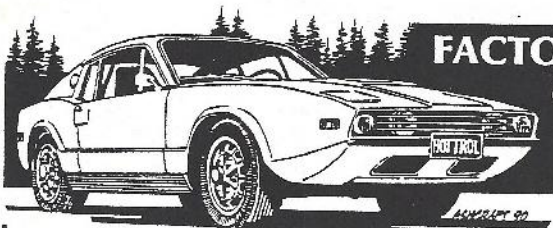

## FACTORY SERVICE & OWNER'S MANUALS

- |   |                                |
|---|--------------------------------|
| 4060--Factory reprint Saab 95/96/97 drivetrain service manual. A MUST for any serious maintenance or overhaul work on these cars. Includes tech articles on V4 overhaul by Jack Ashcraft.               | \$28 Postpaid, USA             |
|   | \$39 Postpaid, Canada          |
| 4061--Factory reprint Sonett III service manual. Use with 4060 drivetrain manual to give full coverage of Sonett III mechanicals & body. Includes several tech articles on Sonett III by Jack Ashcraft. | \$20 Postpaid, USA             |
|   | \$26 Postpaid, Canada          |
| 4062--Sonett III Owner's Manual. Factory reprint of the original for 1974. If your Sonett III is 1970-73, specify the year. I will supply my pages to show the difference for your car.                 | \$10 Postpaid, USA             |
|   | 1974---- \$14 Postpaid, Canada |
|   | 1970-73-- \$13 Postpaid, USA   |
|   | \$17 Postpaid, Canada          |

**AV PARTS**  
JACK ASHCRAFT  
AUTOMOTIVE DESIGN  
2201 Woodlawn Drive, Medford, OR 97504  
503-779-0731

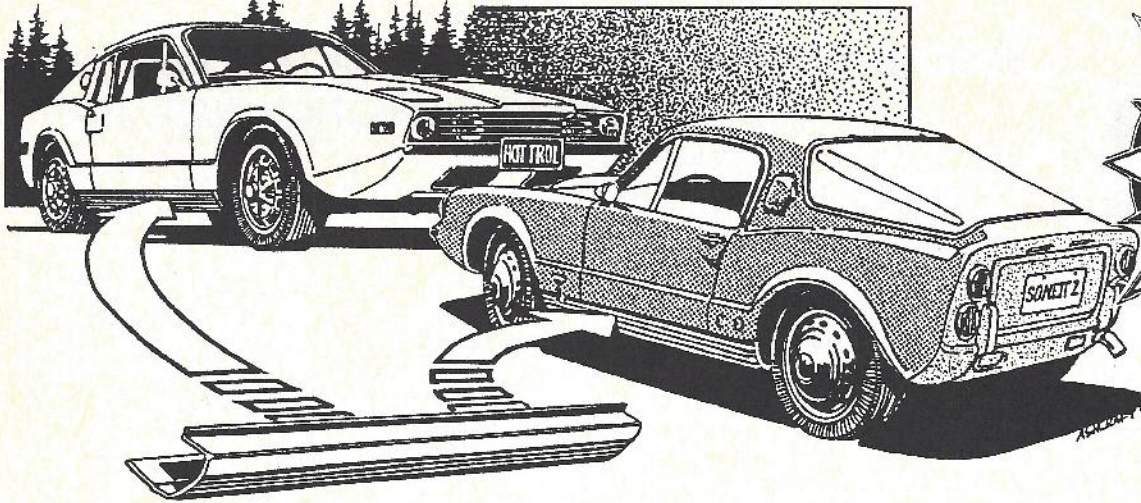

**NEW!**

**SONETT REPLACEMENT  
ROCKER PANELS!**

Set of two.

Order Part No 4099

If I had a buck for every rusted Sonett rocker panel, I'd go to Fiji on extended vacation! Saab is no help so here are the replacements: These heavy 18 gauge (stock 20) units fit right over your old panels. No cutting out the old rockers and getting the whole car tweaked out of shape! You spot, torch or MIG

weld these into place, prime and paint. Simple as that. These new panels extend 4" out under the floor area to cover the rust crack where the old rockers met the floor. You will be amazed how much these babies stiffen up the car! Slight trimming with a sheet metal shears is required. Instructions included.

**FRONT & REAR WINDOW RUBBER  
MOLDING & CHROME LOCK-IN STRIP  
FOR 1967-1974 SONETT!**

LOOKS LIKE THE  
ORIGINAL SONETT  
& LATE MODEL 96  
MOLDING!

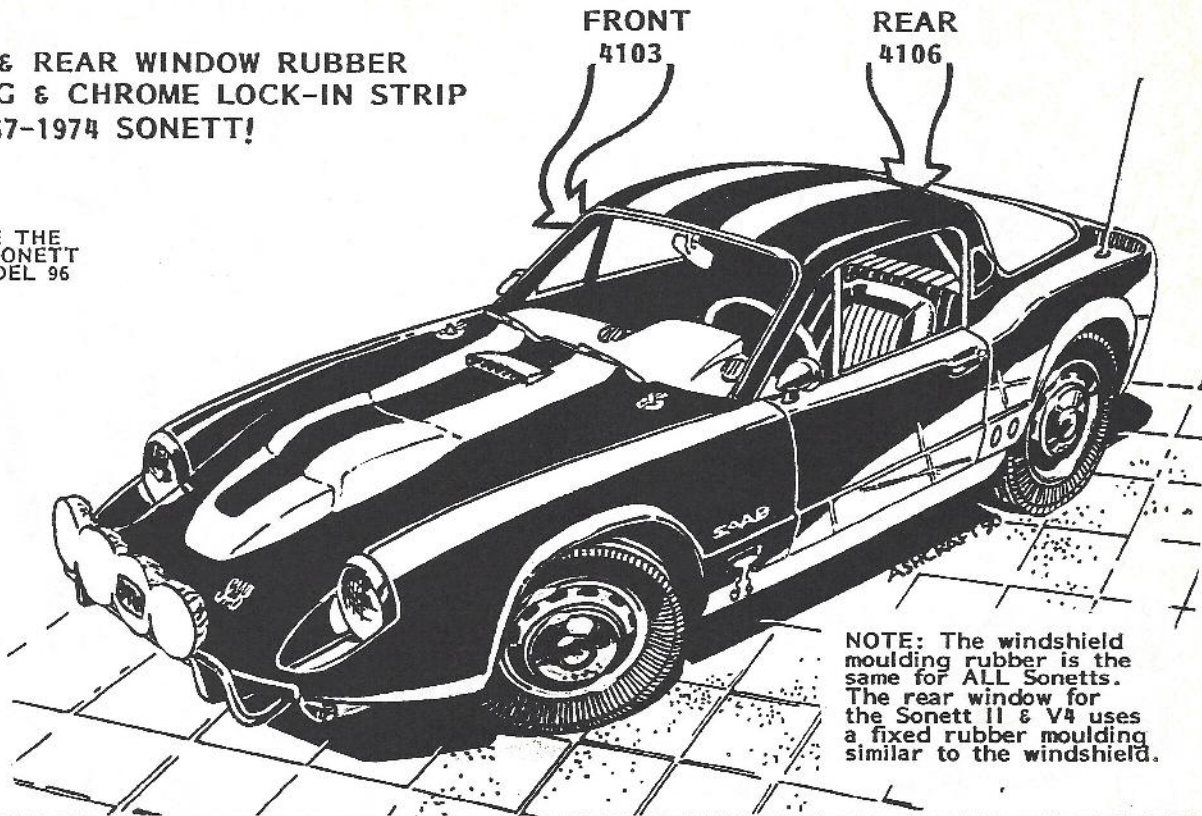
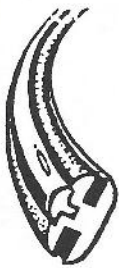

**NOTE:** The windshield moulding rubber is the same for ALL Sonetts. The rear window for the Sonett II & V4 uses a fixed rubber moulding similar to the windshield.

**ALIEN CAR BOOK DEPT.**



Own a SAAB and a FIAT?  
Know a friend with a  
FIAT? Tell him that

Jack Ashcraft has some electrical books for  
FIAT 124 Spider & coupes and for the X1/9!

3001  
FIAT Electrical Systems  
for Everyone.....\$ 48.00 postpaid  
USA

3002  
FIAT Alternator & Starter  
Overhaul Techniques.....\$ 25.00 postpaid  
USA

# SPECIAL PARTS

Item Number	Item	Description
4001	Rebuilt Cylinder Head, Open Deck 1500cc Engine	These cylinder heads are completely rebuilt using V6 Mustang hard exhaust valves, seats and split locks. Guides, intake valves, springs and retainers are replaced as required. Heads are hot-tank cleaned and new freeze plugs and valve seals are installed. Heads are lightly surfaced for perfect fit with your engine block. Spark plug threads are cleaned and the heads are painted. Heads are thoroughly inspected for cracks and other flaws. Use with leaded or unleaded gas.
4002	Head, Closed Deck 1500cc Engine 47mm mount boss depth	
4003	Head, Closed Deck 1700cc Engine 54mm mount boss depth	

This shows an open deck V4 engine. The cylinder bores were cast so that the mounting deck (where the cylinder head mates the block) was open.

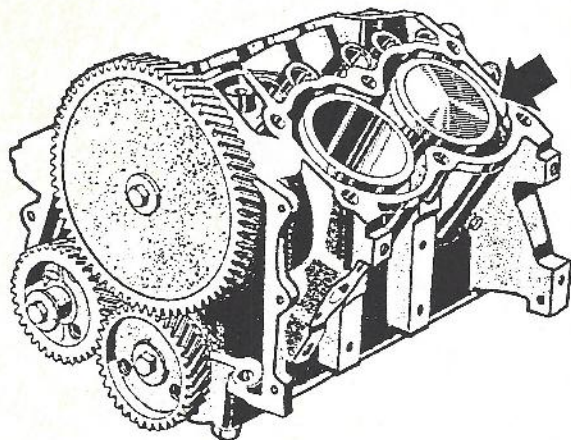

This is a closed deck V4 engine. The mounting deck is a closed surface with openings for free passage of coolant from block to head.

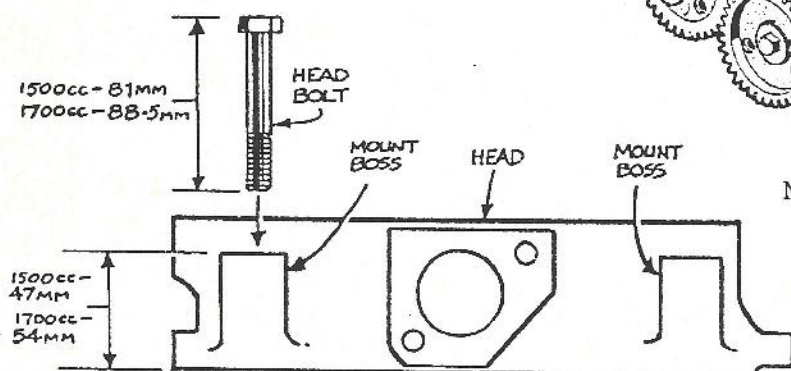
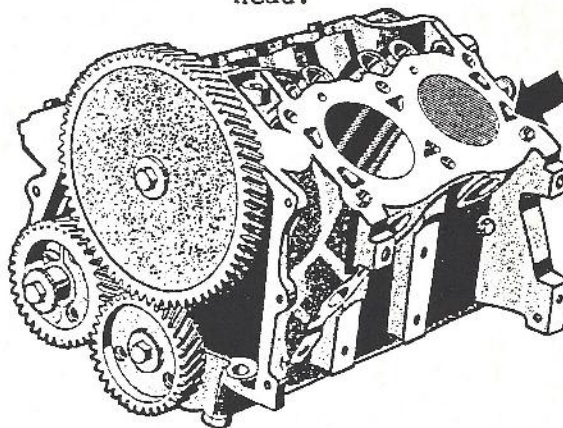

NOTE: HEADS FOR OPEN DECK ENGINES WILL NOT INTERCHANGE WITH HEADS FOR A CLOSED DECK ENGINE! BY THE SAME TOKEN, HEAD GASKETS FOR THE TWO TYPES ARE NOT INTERCHANGEABLE.

All closed deck heads are interchangeable. HOWEVER, there is a difference of length between early and late HEAD BOLTS. If you were to mix things up and use late bolts on early heads it is possible that the bolts could "bottom out" in the block, not tighten down properly and allow the head gasket to blow. Measure your heads AND your bolts. Better to measure now than blow a head gasket and then measure!

Fig 21

# SPECIAL PARTS

4004	Chrome Valve Cover & Anti-Leak Kit For all V4 Engines	These covers are hard chrome plated for many years of good service. They dress up your engine and show you care enough about your car to make it look as well as run good. The anti-leak kit includes 10 studs, nuts, washers and some locktight compound as well as special chromed cover hold downs that really cut oil leaks.
4005	Reconditioned Rocker Arm Assemblies For All V4 Engines	These assemblies are almost all new. New rocker arms, rocker arm shafts, tension washers and roll pins are used. They come to you fully assembled, ready to install.
4006	Reground V4 Camshaft For all V4 Engines	Reground cam done to Iskenderian F4 specifications. Valve lift is .425" and duration is 260°. An excellent street cam that really makes the V4 come alive.



4007	Reground V4 Camshaft For all V4 Engines	Reground cam done to Iskenderian F66 Specifications. Valve lift is .448" and duration is 264°. An excellent street or autocross cam, particularly well suited to the Sonett since it is a lighter car than the 95-96 and can sacrifice a little low end torque for greater top-end power.
4008	Cam Followers (Tappets) All V4's	A must when the engine is overhauled or when a new or reground camshaft is installed. Tappets are ground slightly convex on the surface that touches the cam to rotate the tappet. Old tappets get a strange, partly concave surface that is hard on new cams. It is also usually pitted, and that contributes to cam lobe wear.
4009	Lightened Flywheel All V4's	These light flywheels are also statically balanced. There is less weight in the flywheel mass and the engine revs much more quickly than stock. Flywheel still has enough mass that it won't come apart at high RPM and still smoothes out the idle of the V4 engine. A great all-around improvement.

# SPECIAL PARTS

4010 2 Barrel  
Intake  
Manifold  
  
For all V4's

These manifolds are made up from one barrel units. They have a large carb mount pad welded in place, then are machined out for better flow, available with a two barrel Weber carb. The new mount pad is drilled and tapped and carb mount studs installed. Made for the 2800 Holly-Weber, the 28-36 DCD, the 32-36 DGV or any Weber with the same mounting surface size. These are also tapped for a PCV valve and come with the PCV valve mounted in the manifold. Gaskets & carb isolator included.

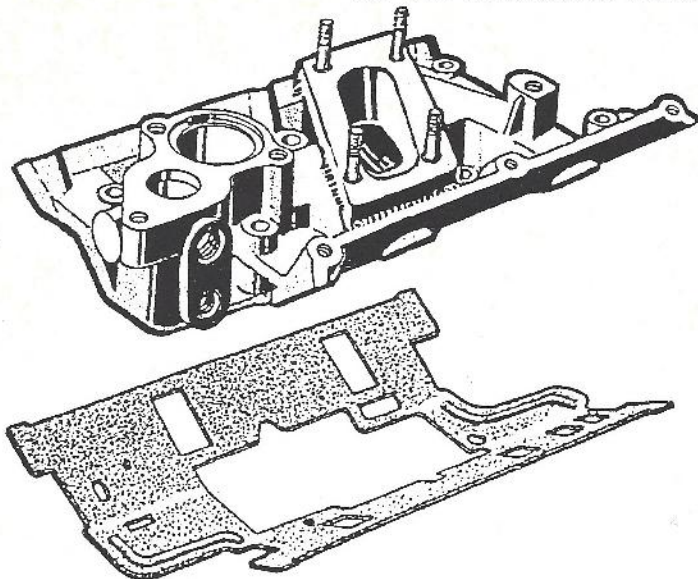

4011 Ball Socket  
Throttle  
Linkage  
  
For all V4's

Replaces the bent-wire-and clip lash up that came as stock on the V4's. Uses two 3/16" ball sockets and interconnecting throttle rod. Makes throttle action super smooth!

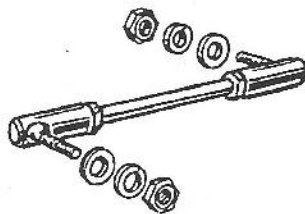

4012 Rebuilt V4  
Distributors  
  
For all V4's

These units are re-bushed, thoroughly cleaned, and have the centrifugal advance curves set to 1968-9 spec's. New parts used include the bushings, points, condensor, rotor, cap, vacuum control unit, spark plug wires and two plug wire separators.

4013 High Performance  
Cap & Wire Set  
For all V4's

Includes solid wire Packard 440 plug and coil wire, premium insulator boots for distributor, spark plug and coil connections, Heavy duty distributor cap and two spark plug wire separators.

# SPECIAL PARTS

4014	Heat Control Valve for Sonett III	Replacement unit. Mounts in engine bay, uses stock cable. Includes necessary clamps, hardware and hose to install. You'll have to drill a couple of holes to mount it in your Sonett. Smooth, positive action.
4014A	Heat Control Valve for Sonett II & V4	Same as 4014 but with different hardware and new, longer cable. Comes with complete instructions, looks, works good!
4015	Heat Control Valve for Saab 95, 96 1965-73	Replacement unit, mounts on engine bay cross bar, uses stock cable. Clamps, mounting hardware & instructions included.
4016	Clutch Master Cylinder Changeover Kit--fits all Sonetts and 1965-68 Saab 96 & 96.	This is a Japanese unit which is a direct replacement for the original Girling cylinder. Should outlast the original several times. Includes mounting hardware, new flex hose and complete instructions.
4017	Sonett Wheel Fitting Studs Chrome Plated  For all Sonetts. Work well on 95 and 96 too.	It's hard enough to put steel wheels back on a Sonett. With the late mags it's a career occupation-sit-in-the-mud sort of thing. These two chrome plated studs handle the problem so well you'll want to go change tires on your car just to see how well they work! Slotted for a screwdriver in case your hub threads are sticky, but usually they thread in and out by hand.
4018	Same thing, but zinc plated	
4019	Microswitch Kit, Sonett III	This kit replaces the stock Sonett headlight microswitch that is by now cooked to a cinder by the left header. Replaces either the early or late microswitch in your car, is a heavy duty unit that should outlast the original.
4020	Stop Light Switch Kit, all Sonetts	This one goes INSIDE the car by the brake pedal and it should last longer than you do. Saab should have done it this way.
4021	Door Weatherstrip Kit, Sonett 2 & V4	Very close to the original stuff. Kit includes enough to do both doors. Better sealing than with the original. Color is black.
4022	Door Weatherstrip Kit, Sonett III	Same weatherstrip as for Sonett 2 but includes enough strip to replace the strip around the rear quarter windows as well.
4023	Door weatherstrip Kit, 95 and 96	Same weatherstrip as for the Sports cars but correct length for the sedan versions.
4024	Rear Side Window Weatherstrip, 96	Good replacement for the shrunken weather seal on the sedan rear side windows. Stops leaks and wind noise.
4025	Luggage Door Seal Kit, Sonett 2 & V4	Cut out the noise and exhaust fumes. Replace cracked, shrunken and worn-out standard seal. Good stuff. You'll like it.



# SPECIAL PARTS

4026

Glass Hatch Seal  
Sonett III

Tired of leaks back there? This will cure all that and stop the exhaust fume smell as well. Comes with instructions about adjusting the rear glass latch to minimize the possibility of breakage.

4027

Shoulder Harness  
95,96 & all Sonetts

New three point nylon belts. Meet or exceed Federal safety requirements. No retractors. These hold you in place for DRIVING not just for CRASHING. Available in black, grey, brown or red. Specify.

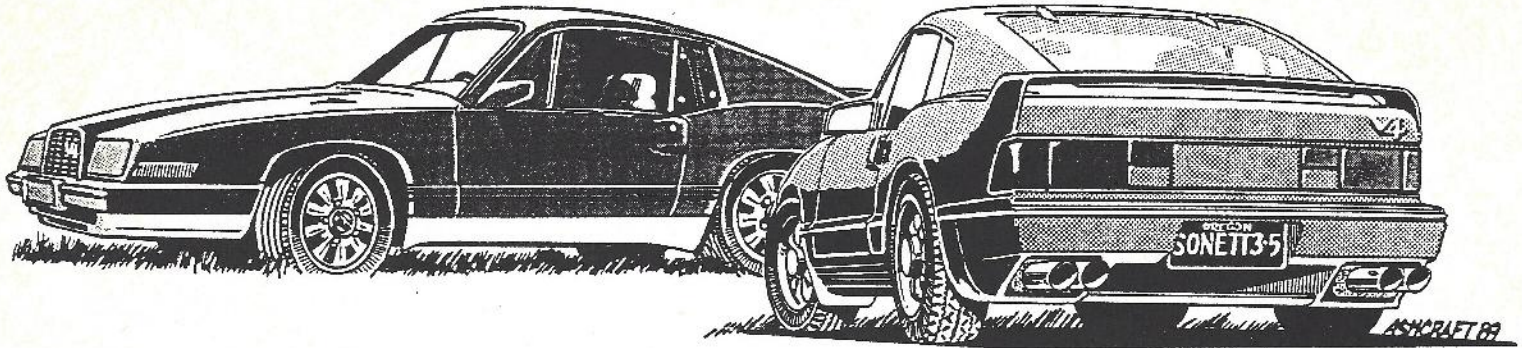

**ASHCRAFT**  
**PARTS**

JACK ASHCRAFT  
AUTOMOTIVE DESIGN  
2201 Woodlawn Drive, Medford, OR 97504  
503-779-0731

# NEW PRODUCTS!

## COOLANT FILTERING SYSTEMS

### V4 SAAB-- STOCK SYSTEM

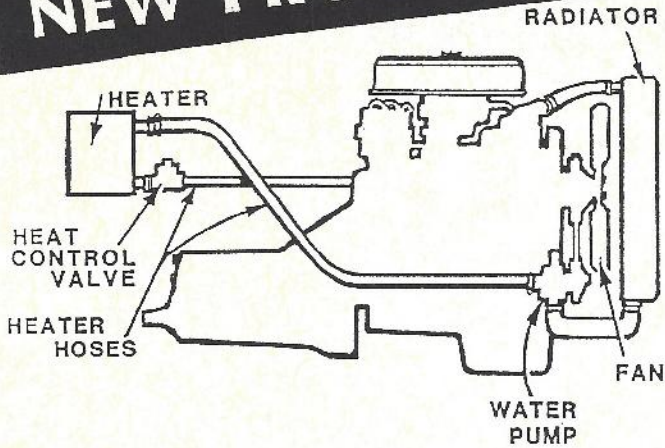

4044--SAAB 95/96.....\$79.00

4045--SAAB Sonett V4.....\$89.00

4046--SAAB SONETT III.....\$89.00

4044A--EXTRA SPIN-ON FILTERS...\$13.00

### V4 SAAB WITH COOLING SYSTEM FILTER

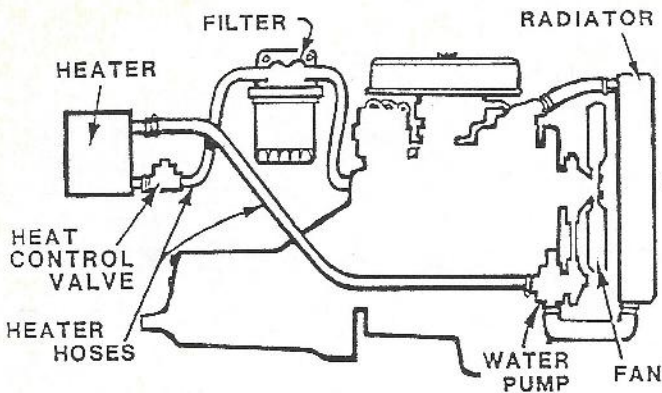

COOLANT FILTERING SYSTEM IS SIMILAR TO THOSE USED IN BIG DIESEL TRUCKS BUILT TO LAST A MILLION MILES. EASILY MOUNTED, CONNECTS TO HEATER HOSES. TIME RELEASE CAPSULE IN SPIN ON/OFF FILTER DISPENSES CONDITIONER FOR 12 MONTHS/ 12,000 MILES. KEEPS RADIATOR EFFICIENT, COOLING SYSTEM CLEAN, EXTENDS WATER PUMP LIFE. THIS THING REALLY WORKS! COMPLETE INSTRUCTIONS INCLUDED.



### SONETT TRANSAXLE NOISE REDUCER KIT

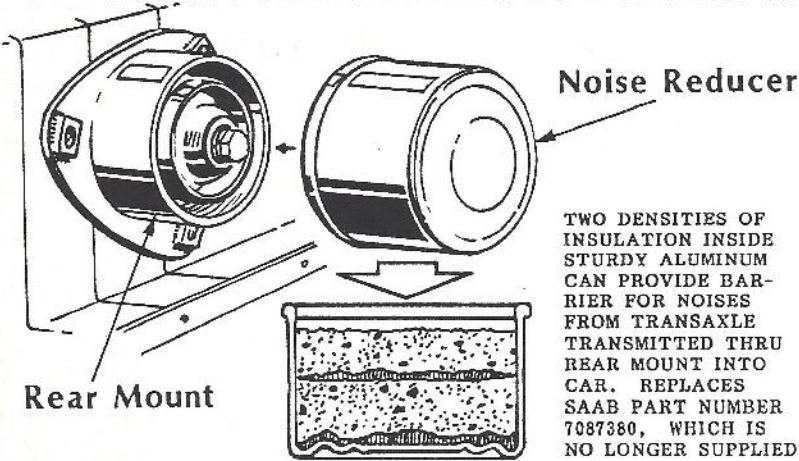

TWO DENSITIES OF INSULATION INSIDE STURDY ALUMINUM CAN PROVIDE BARRIER FOR NOISES FROM TRANSAXLE TRANSMITTED THRU REAR MOUNT INTO CAR. REPLACES SAAB PART NUMBER 7087380, WHICH IS NO LONGER SUPPLIED.

4047--NOISE REDUCER KIT  
FITS ALL SONETTS ....\$8.00

### SONETT SHIFTER KIT

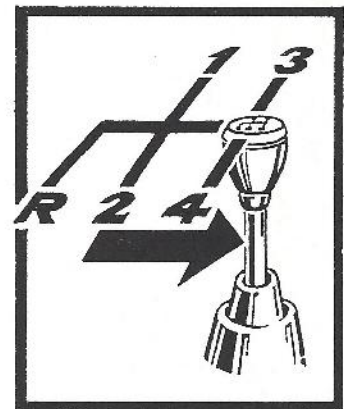

SIMPLE KIT LOCATES SHIFT LEVER TO 3RD/4TH QUADRANT AS IN CURRENT CARS. HELPS PREVENT SHIFTS INTO THE WRONG GEAR, ESPECIALLY INTO REVERSE ON 3RD-TO-2ND DOWN-SHIFT (EASY TO DO ON A HARD RIGHT TURN). EASY TO INSTALL TRANSMISSION SAVER!

4040--SONETT 3RD/4TH GEAR  
SHIFT GATE CONTROL KIT.....\$12.00

### REBUILT V4 OIL DIPSTICK

DON'T TAKE A CHANCE! A BAD OIL DIPSTICK CAN LEAD TO AN ENGINE WITHOUT ENOUGH OIL! THESE REBUILT UNITS ARE BRAZED, NOT CRIMPED TOGETHER.

CHOICE OF PAINTED OR CHROMED.

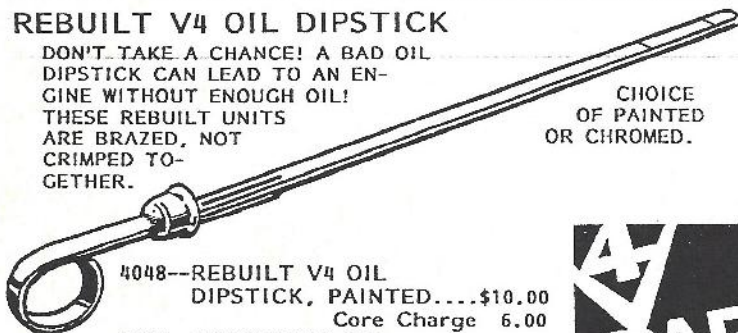

4048--REBUILT V4 OIL  
DIPSTICK, PAINTED...\$10.00  
Core Charge 6.00

4049- REBUILT V4 OIL  
DIPSTICK, CHROMED...\$16.00  
Core Charge 6.00

# 4 PARTS

JACK ASHCRAFT  
AUTOMOTIVE DESIGN  
2201 Woodlawn Drive, Medford, OR 97504  
503-779-0731

# NEW PRODUCTS!

## REBUILT V4 DISTRIBUTOR

Rebuilt V4 distributor with advance curve set to 1968 factory specs. Includes new bushings, points, condenser, rotor, cap, wire set, 2 wire separators, new vacuum control unit, instructions.

**\$190**  
EXCHANGE

\$50 core charge if your unit is not rebuildable. Shipping extra.

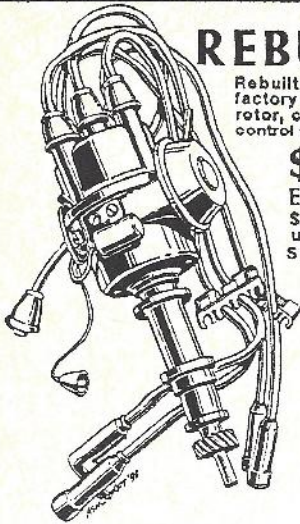

- 4012--Rebuilt Distributor, V4, Exchange...\$190.00 Exch
- 4012A--Same distributor for V4, without cap and wires & wire separators..... 160.00 Exch
- 4011A--V4 Ball socket throttle link for REAR vertical throttle rod. SMOOTH throttle!\$25.00
- 4011B--Complete V4 throttle linkage set, with BOTH short and long rods PLUS front and rear rotating rod bushings.....\$59.00
- 4041--Sonett clutch pedal stop kit. Limits pedal movement. Needed on some installations to keep release arm from hitting the pressure plate.....\$15.00
- 4042--V4 rebuilt clutch release arm kit. Includes arm and clevis pin fix to take the slop out of the clutch linkage....\$39.00Exchg
- 4043--Weatherstrip kit, Sonett heater air intake Keep engine fumes out of car..\$10.00

## AUTOMOTIVE ELECTRICAL SYSTEM TESTING METERS

YOU'VE READ THE ELECTRICAL BOOKS--NOW GET THE TEST METERS TO TEST THE ELECTRICS IN YOUR CAR!

REPAIR JUST ONE ALTERNATOR OR ONE STARTER INSTEAD OF BUYING A NEW OR REBUILT UNIT AND YOU'VE MORE THAN PAID FOR THE TESTERS!

INDUCTIVE STARTER & ALTERNATOR AMMETERS ARE USED WITHOUT DISCONNECTING ANY CABLES YET TELL YOU WHATS GOING ON IN THE UNIT AS YOU START AND RUN THE ENGINE!

HANDY MULTIMETER MEASURES VOLTAGE AND RESISTANCE IN EVERY CIRCUIT IN YOUR CAR. ALSO MEASURES HOUSE (AC) VOLTAGE. A VERY USEFUL TOOL FOR HOME AND SHOP!

EASY TO USE--INSTRUCTIONS INCLUDED WITH EACH METER

- 4056--INDUCTIVE ALTERNATOR AMMETER...\$24.00 plus shipping and handling
- 4057--INDUCTIVE STARTER AMMETER.....\$39.00 plus shipping and handling
- 4058--MULTIMETER.....\$20.00 plus shipping and handling
- 4059--ALL THREE METERS (\$5.00 OFF).....\$78.00 plus shipping and handling

### SHIPPING AND HANDLING:

- ANY ONE METER.....USA.....add \$5.00 CANADA.add \$11.00
- 2 OR 3 METERS.....USA.....add \$7.00 CANADA.add \$13.00

### 4056--ALTERNATOR TESTER

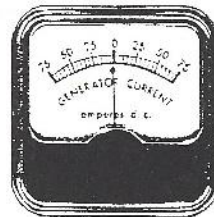

TESTING ALTERNATOR OUTPUT WITH AN INDUCTION AMMETER

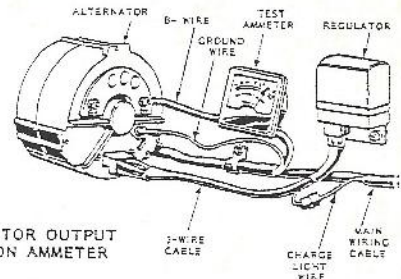

### 4057--STARTER TESTER

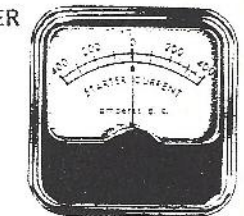
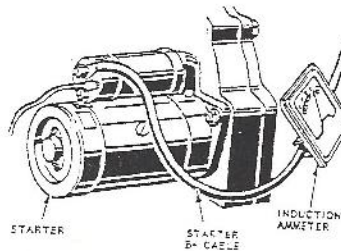

USING THE INDUCTION AMMETER TO TEST STARTER CURRENT

### 4058--MULTIMETER

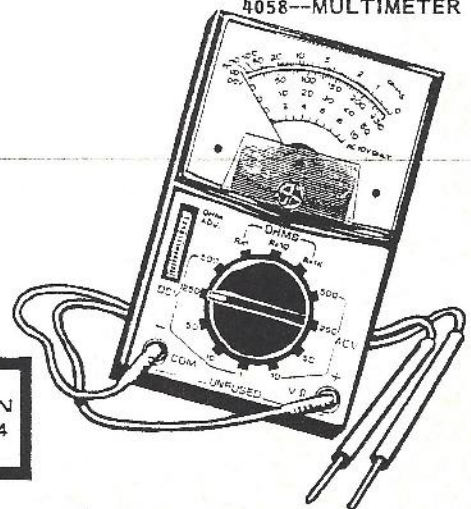

**AV PARTS**

JACK ASHCRAFT  
AUTOMOTIVE DESIGN  
2201 Woodlawn Drive, Medford, OR 97504  
503-779-0731



# TOO NEW TO GET IN THE CATALOG!

PART NO.	NEW ITEM	COMMENTS OR OTHER DESCRIPTION	PART PRICE
4011	V4 Front (short) Ball Socket Throttle linkage	Takes most of the slop out of the throttle linkage. Fits all 95,96 & Sonett V4 & III	\$ 20.00
4011A	V4 Rear (long) Ball Socket Throttle Linkage	Takes more slop out of the linkage. Makes the movement very crisp & smooth. This is the forgotten part of the linkage. Fits all Saabs with V4 engines.	25.00
4011B	Complete Ball Socket Throttle Linkage Set. Includes 4011, 4011A and two replacement bushings.	Takes all the slop out of the linkage. The 2 bushings fit the ends of the rotating bar portion of the V4 throttle linkage. Nice!	59.00 Set
4011D	V4 RACING Throttle Linkage. Similar to 4011 but with race quality parts	The joints are the big news here: Racing quality Heim socket joints on each end of the shaft. Absolutely butter smooth and so so close to zero rotation resistance you won't believe it. This is what I use on the race car.	39.00
4011E	V4 RACING Throttle Linkage. Similar to 4011A but with race quality parts	This is the vertical rear throttle link with Heim style socket joints on each end. Great!	44.00
4011F	Complete RACING Linkage Set.	Similar to 4011B. Includes 4011D, 4011E and 2 replacement bushings for the rotating shaft. Our finest throttle linkage!	89.00
4035	Sonett III Hood Door Weatherstrip	This is an almost exact replacement item for the weatherstrip that went around about 3/4 of the hood opening. Easy to install.	19.00
4036	Sonett 2 or V4 Hood Weatherstrip set	Replaces worn weatherstrip at top of engine bay walls on each side, as well as the 16" vertical pieces on each side of the car, at rear of the fenderwells.	28.00
4037	Saab 95,96 Back-of-hood Weatherstrip	Replaces original perfectly. Seal weather out of that newly restored and painted engine bay!	12.00
4038	Saab 96 Trunk door Weatherstrip	Replace that worn and cracked trunk door seal. This new one fits on the body, not the door, looks good and seals very well. A good product.	27.00
4039	Saab 95,96,97 Transaxle Freewheel neuter kit (V4s)	Remove the freewheel function, a vestigial remnant of two cycle days when freewheeling was necessary to preserve the engine when the throttle was closed. The V4 engine has too much torque for the freewheel unit! Lock it out permanently and join the 20th Century!	12.00
4095	Sonett II or V4 Steel Toe Boards	Set of 2 pieces. Goes under the carpet where your toes touch. Replace rusted, damaged or missing parts. 2 piece set.	75.00
4096	Sonett III Steel Toe Boards	Set of 2 pieces. Similar to 4095 but they are not the same shape. Don't overlook this in your restoration!	77.00
4097	Battery Box Replacement Fits all Sonetts.	18 gauge steel box fits into the floor. You trim out the rusted area under your battery plus a bit more for the new box. You can weld or rivet this box in place. Comes with an 18 gauge steel reinforcement angle to fit across the front of the trunk floor. 3 pieces.	69.00
4098	Sonett 3/4 Trunk Floor. Fits all Sonetts.	18 gauge steel floor fits the FORWARD 3/4 of the floor. Use with 4097 to replace badly rusted or corroded forward 3/4 section of the Sonett trunk floor. Weld or rivet in place.	129.00
4107	Sonett II or V4 Chrome Rocker Panel Sill.	Brighten up the inside of the car and protect the door sill at the same time. Made of heavy 18 gauge steel beautifully chrome plated. Fits perfectly. Easy to install. 2 pieces.	79.00
4108	Sonett III Chrome Rocker Panel Sill plate. For 1970-early 73 Sonetts (cars with OUT the sill strap for side crash door protection).	Protects the sill area of the rocker panel and looks great at the same time! Complete installation instructions included with the plates. 2 pieces.	84.00
4109	Late Sonett III Chrome Sill plate protector. Similar to 4108 but has cutout area for sill strap on late 73 and all 74 Sonetts.	A great looking addition to the Sonett that is practical as well. Keeps the sill area free of unsightly scratches. Easy to clean. Easy to install. 2 pieces.	88.00
4110	Sonett II or V4 Chrome Plated cabin roll bar and roll bar braces.	Exchange set includes the main roll bar plus the two side brace bars plus two stainless bolts, nuts & washers. Really makes the interior come alive! Super dress-up item!	160.00 Exchg
4111	Sonett III 70-early 73 Chrome plated cabin roll bar. Fits cars with OUT glass hatch hydraulic lift struts.	Exchange roll bar. Triple chrome plated to show off the car. Will wear almost indefinitely. Cleans, polishes easily. Nice!	109.00 Exchg

OVER

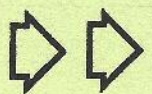

PART NO.	NEW ITEM	COMMENTS OR OTHER DESCRIPTION	PART PRICE
4112	Sonett III late 73 and all 74 Chrome cabin roll bar. For cars WITH hydraulic hatch struts.	Exchange roll bar similar to 4111 except has the threaded holes for the hydraulic strut mounts. Beautiful!	\$ 109.00 Exchg
4113	Sonett III Chrome Plated Gas Strut Mount. Fits late 73 and all 74 cars.	Exchange mount. This is the piece with 10 holes cut in it just behind the hatch glass at the front of the glass. Chrome on the OUTside, flat black on the INside. Super!	48.00 Exchg
4115	Sonett II or V4 Fuel Filler Rubber Grommet	This is the large rubber insulator gasket between the fuel filler neck and the fender of the car. Replace cracked, damaged or missing grommet. This replacement is just slightly smaller in overall diameter than the original, has same inside diameter and fits very well. Easy to install. Looks great!	19.00
4116	Sonett II or V4 Exhaust Pipe Insulating Grommet	Replace the cracked or missing noise insulator on your exhaust pipe outlet. I used 2 of them on my Sonett V4 and ran dual exhaust out thru the body, one on each side. They look great and they don't rattle!	20.00
4117	Saab 95-96 Fuel Filler Rubber Grommet	Replace the shabby old filler grommet on your car. This easy-to-install replacement is slightly smaller in overall diameter than the original. Looks real good!	21.00

#### KEY BLANKS

4120	Key blank, ignition, Sonett II & V4	Replacement for the original Saab key	\$4.00each
4121	Key blank, door, Sonett II & V4	Replacement for the original Saab key	4.00each
4122	Key blank, ignition, Sonett III	Replacement for the original Saab key	4.00each
4123	Key blank, door, Sonett III	Replacement for the original Saab key	4.00each
4124	Key blank, door & ignition, Saab 95,96, up to 1972	Replacement for the original Saab key	4.00each
4125	Key blank, door & ignition, Saab 95,96, 1972 and later cars	Replacement for the original Saab key	4.00each

#### BRAKE PARTS

4130	Saab 95/96/97 Front flexible brake hose	Replace the worn, chaffed, cracked flex hose that no longer passes fluid in both directions. These hoses are the most common cause of a draggin or locked up front caliper. High quality replacement!	28.00each
------	---	---	-----------

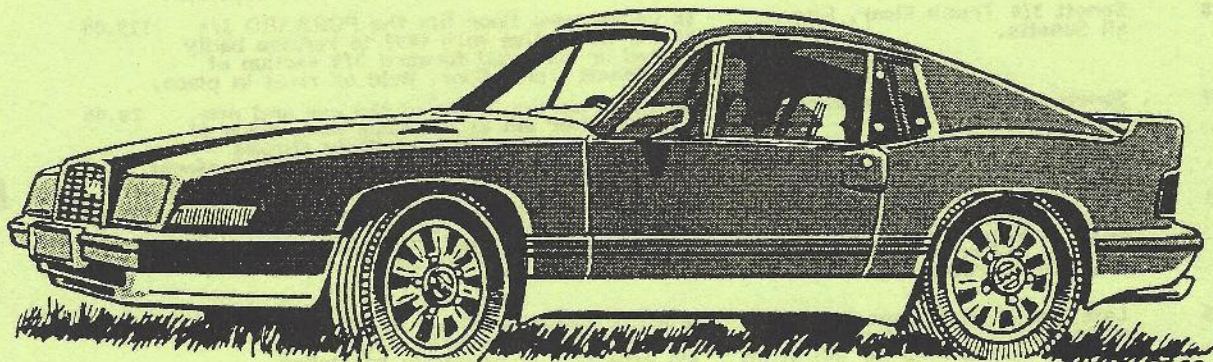

**44**  
**PARTS**

JACK ASHCRAFT  
AUTOMOTIVE DESIGN  
2201 Woodlawn Drive, Medford, OR 97504  
503-779-0731

**IT'S SONETT RESTORATION TIME  
AND WE HAVE THE PARTS!**

# MASTER PRICE LIST



Prices effective 1 Sept 91.  
All earlier price lists void.  
Prices subject to change  
without notice.

## ALL CATALOG ITEMS

Part No.	Description	Core Charge	Part Price	
4001	Cylinder Head, 1500cc, for early open deck engines	\$100.00pr	\$320.00pr	exchg
4002	Cylinder Head, 1500cc, for closed deck engines	100.00pr	320.00pr	exchg
4002A	Cylinder Head, HiPerformance, 1500cc closed deck engine	100.00pr	520.00pr	exchg
4003	Cylinder Head, 1700cc, for closed deck engines	100.00pr	320.00pr	exchg
4003A	Cylinder Head, HiPerformance, 1700cc closed deck engine	100.00pr	520.00pr	exchg
4004	V4 Valve Cover, ChromePlated, with anti-leak kit, gskts	25.00pr	95.00pr	exchg
4004A	V4 Valve Cover, ChromePlated, only	25.00pr	80.00pr	exchg
4004B	V4 Valve Cover Gaskets (2)	0	8.00pr	
4004C	Anti-leak kit, V4 valve covers	0	14.00set	
4005	Rocker Arms, rebuilt V4 set	25.00pr	250.00pr	exchg
4006	Camshaft, hi-performance regrind, F4 spec	25.00	75.00	exchg
4007	Camshaft, hi-performance regrind, F66 spec	25.00	75.00	exchg
4008	Cam followers, new, set of 8	0	96.00	
4008A	Cam kit--F4 cam, cam follower set, cam bearings, cam plug	25.00	197.00	exchg
4008B	Cam kit--F66cam, cam follower set, cam bearings, cam plug	25.00	197.00	exchg
4009	Flywheel, lightened	45.00	85.00	exchg
4009A	Flywheel kit, light flywheel with new mounting bolts	45.00	109.00	exchg
4010	Intake manifold, 2 BBL, with gasket	50.00	350.00	exchg
4011	Throttle Link, front (short) with ball sockets	0	20.00	
4011A	Throttle Link, rear (long) with ball sockets	0	25.00	
4011B	Throttle Link KIT, incl. front, rear links plus 2 bushings	0	59.00	
4011C	Throttle Link, Racing, front, with Heim joints	0	39.00	
4011D	Throttle Link, Racing, rear, with Heim joints	0	44.00	
4011E	Throttle Link KIT, Racing, incl. fr., r. Heim jts + 2 bushings	0	89.00	
4012	Distributor, V4, rbld, with new pts, cond, rtr, wires, vac, cap	50.00	190.00	exchg
4012A	Distributor, V4, rbld, with new pts, cond, rtr, vac adv only	50.00	160.00	exchg
4012B	Distributor, V4, rbld, w/electronic ignition, cap, wires, vac	50.00	295.00	exchg
4013	Distrib Cap, wire set, HiPerformance	0	49.00	
4014	Heat Control Valve, for Sonett III, SonV4 after Ser# 1258	0	59.00	
4014A	Heat Control Valve, for Sonett II & V4 up to ser# 1258	0	69.00	
4015	Heat Control Valve, for Saab 95/96 1965-73	0	49.00	
4016	MasterCylinder, Clutch, changeover kit, all Sonett, 65-68 95/96	25.00	125.00	exchg
4017	Studs, Sonett mag wheel installing, ChromePlated	0	12.00pr	
4018	Studs, Sonett mag wheel installing, Zinc Plated	0	9.00pr	
4019	Microswitch kit, Sonett III	0	29.00	
4020	Stoplight switch kit, Sonett III	0	24.00	
4020A	Stoplight switch kit, Sonett II & V4	0	29.00	
4021	Weatherstrip kit, doors, Sonett II & V4	0	69.00	
4022	Weatherstrip kit, doors & side vent windows, Sonett III	0	79.00	
4023	Weatherstrip kit, doors, Saab 95,96	0	59.00	
4024	Weatherstrip kit, Saab 96 rear side windows	0	39.00	
4025	Weatherstrip kit, Sonett II & V4 luggage door	0	23.00	
4026	Weatherstrip kit, glass hatch, Sonett III	0	36.00	
4027	Shoulder Harness, 3-point kit, Sonett (all), 95,96, Black	0	72.00pr	
4027A	Shoulder Harness, 3-point kit, Sonett (all), 95,96, Gray	0	77.00pr	
4027B	Shoulder Harness, 3-point kit, Sonett (all), 95,96, Red	0	77.00pr	
4027C	Shoulder Harness, 3-point kit, Sonett (all), 95,96, Tan	0	77.00pr	
4035	Weatherstrip kit, hood opening, Sonett III all	0	19.00	
4036	Weatherstrip kit, 4-piece, hood opening, Sonett II & V4	0	28.00	
4037	Weatherstrip kit, Saab 95/96 back-of-hood opening strip	0	12.00	
4038	Weatherstrip kit, trunk opening, Saab 96	0	27.00	
4039	Neuter Kit, Saab 95/96/97 transaxle	0	12.00	
4040	Shift Control Kit, 3rd/4th gate, Sonett III	0	12.00	
4041	Clutch Pedal Stop Kit, All Sonetts	0	19.00	
4042	Clutch release arm ass'y, rebuilt	20.00	39.00	exchg
4043	Weatherstrip kit, Sonett heater air intake opening	0	10.00	

MASTER PRICE LIST

Part No.	Description	Core Charge	Part Price
4044	Coolant filter kit, Saab 95/96	\$ 0	\$ 79.00
4045	Coolant filter kit, Sonett II & V4	0	89.00
4046	Coolant filter kit, Sonett III	0	89.00
4047	Noise Deadener, Sonett transaxles	0	8.00
4048	Dipstick, V4, Rebuilt, painted	6.00	10.00 exchg
4049	Dipstick, V4, Rebuilt, chrome plated	6.00	16.00 exchg
4050	Book, DREAMS & DETAILS, 30 YEARS WITH SAABS	0	24.00 USA, Can
		0	26.00 O'seas
4051	Book, SONETT SOURCES, interchange parts manual	0	15.00 USA, Can
		0	17.00 O'seas
4052	Book, SAAB ELECTRICS FOR EVERYONE electrical manual	0	40.00 USA, Can
		0	44.00 O'seas
4053	Book, SAAB ALTERNATOR & STARTER OVERHAUL manual	0	20.00 USA, Can
		0	22.00 O'seas
4054	Book, SONETT III FOUR HEADLITE CONVERSION how-to	0	12.00 USA, Can
		0	15.00 O'seas
4056	Test meter--to test alternators	0	29.00
4057	Test meter--to test starters	0	43.00
4058	Multimeter--for general auto & household elect. testing	0	20.00
4059	All three meters--save \$5.00	0	87.00
4060	Service Manual--factory reprint--Saab 95/96/97 drivetrain, with tech articles	0	28.00 USA
		0	34.00 Canada
4061	Service Manual--factory reprint--Sonett III, w/tech articles	0	20.00 USA
		0	26.00 Canada
4062	Qwner's Manual, Sonett III for 1974. Factory reprint	0	10.00 USA
		0	14.00 Canada
4062A	Owner's Manual, Sonett III for 1970, 71, 72 or 73	0	13.00 USA
		0	17.00 Canada
4063	Book, Sonett Tech articles	0	12.00 USA
		0	16.00 Canada
4064	Book, V4 Tech articles	0	12.00 USA
		0	16.00 Canada
4067	Spot Remover for cloth and carpet	0	8.00
4068	Vinyl Upholstery cleaner	0	7.00
4069	Vinyl, rubber & leather protector	0	9.00
4070	Headliner kit, Sonett III, saddle color	0	150.00
4070A	Headliner Kit, Sonett III, light gray color	0	150.00
4071	Bulkhead Cap, short, carpet, saddle color Sonett III	0	75.00
4071A	Bulkhead Cap, short, vinyl, stitched, saddle color Sonett III	0	95.00
4071B	Bulkhead Cap, long, carpet, saddle color Sonett III	0	100.00
4071C	Bulkhead Cap, long, vinyl, stitched, saddle color, Sonett III	0	125.00
4071D	Bulkhead Cover, full, carpet, saddle color, Sonett III	0	150.00
4071E	Bulkhead Cover, full, vinyl, stitched, saddle color Sonett III	0	195.00
4071J	Luggage Floor Carpet, saddle color Sonett III	0	70.00
4072	Luggage area sides Kit, 3-Piece, vinyl, unstitchd Sonett III	0	230.00
4072B	Luggage area sides Kit, 3-Pc, saddle vinyl, stitched Sonett III	0	270.00
4073	Cabin Carpet Set, 11-Pc, Saddle tan Sonett III	0	225.00
4074	Door Panels, early car, Saddle Vinyl, unstitched Sonett III	0	140.00pr
4074B	Door Panels, early car, Saddle Vinyl, stitched Sonett III	0	180.00pr
4074D	Door Panels, late car, Saddle Vinyl, unstitched Sonett III	0	140.00pr
4074F	Door Panels, late car, Saddle Vinyl, stitched Sonett III	0	180.00pr
4075	Seat Insert Kit, saddle, as original, cloth Sonett III	0	295.00pr
4075A	Seat Insert Kit, saddle, Cal custom cloth Sonett III	0	295.00pr
4076	Full Uph Set, 4070, 4071, 4072, 4073, 4074, 4075 Sonett III	0	Total Combined
			Price Less \$50.00
4080	Headliner, Lt Gray cloth, Sonett II or V4	0	195.00
4081	Bulkhead Cap, short, carpet, Dk Gray Sonett II or V4	0	75.00
4081A	Bulkhead Cap, short, carpet, Black Sonett II or V4	0	75.00
4081E	Bulkhead Cap, short, vinyl, stitched, black Sonett II or V4	0	95.00
4081F	Bulkhead Cap, long, carpet, Dk Gray Sonett II or V4	0	100.00
4081G	Bulkhead Cap, long, carpet, Black Sonett II or V4	0	100.00
4081H	Bulkhead Cap, long, Black Vinyl, stitched Sonett II or V4	0	125.00
4081B	Bulkhead Cover, full, carpet, Dk Gray Sonett II or V4	0	150.00
4081C	Bulkhead Cover, full, carpet, black Sonett II or V4	0	150.00
4081D	Bulkhead Cover, full, Black Vinyl, Stitced Sonett II or V4	0	195.00
4082	Luggage Floor Carpet, Dk Gray Sonett II or V4	0	70.00
4082A	Luggage Floor Carpet, Black Sonett II or V4	0	70.00



Part No.	Description	MASTER PRICE LIST	Core Charge	Part Price
4083	CabinCarpetSet, DkGray	Sonett II or V4	\$ 0	\$195.00
4083A	CabinCarpetSet, Black	Sonett II or V4	0	195.00
4084	DoorPanels, NubbyBlackStitched Vinyl	Sonett II or V4	0	180.00pr
4085	LuggageAreaSides, 4-Pc, Stitched Vinyl,	Sonett II or V4	0	160.00set
4086	Luggage Door Carpet, DkGray	Sonett II or V4	0	40.00
4086A	Luggage Door Carpet, Black	Sonett II or V4	0	40.00
4087	Seat Insert Kit, W/O Pads, NubStchdVinyl, dkGray"	" "	0	250.00pr
4087A	Seat Insert Kit, W/O Pads, NubStchdVinyl, black "	" "	0	250.00pr
4087B	Seat Insert Kit, With Pads, NubStchdVinyl, dkGray "	" "	0	295.00pr
4087C	Seat Insert Kit, With Pads, NubStchdVinyl, black "	" "	0	295.00pr
4088	Luggage Door Strap, Leather, black	Sonett II or V4	0	15.00
4088A	EmergencyBrkCover, Vinyl, DkGray	95/96/97	0	15.00
4088B	EmergencyBrkCover, Vinyl, Black	95/96/97	0	15.00
4088C	EmergencyBrkCover, Vinyl, Saddle	95/96/97	0	15.00
4089	Full Uph Set, 4080, 4081, 4082, 4083, 4084, 4086, 4087		0	Total Combined Price Less \$50.00
4090	Dash Top Pad, Saab 95/96		0	35.00
4091	Hat Shelf Pad, Saab 96		0	35.00
4092	Cabin Carpet Set, Saab 95/96, black w/black heel pad		0	150.00
4092A	Cabin Carpet Set, Saab 95/96, black w/gray heel pad		0	150.00
4092B	Cabin Carpet Set, Saab 95/96, dkGray w/black heel pad		0	150.00
4093	Trunk Carpet, Saab 96, black		0	50.00
4093A	Trunk Carpet, Saab 96, dkGray		0	50.00
4094	Full Carpet & Pad Set, 4090, 4091, 4092, 4093		0	Total Combined Price Less \$15.00
4095	Toe Board Set, Sonett II or V4		0	75.00
4096	Toe Board Set, Sonett III		0	77.00
4097	Battery Box Replacement--All Sonett		0	69.00
4098	Trunk Floor, front 3/4 replacement--Sonett III		0	129.00
4098A	Trunk floor, rear 1/4 replacement--Sonett III		0	29.00
4098B	Trunk floor, full replacement kit-- Sonett II & V4		0	139.00
4099	Rocker Panels--all Sonett		0	195.00 pr
4103	Windshield Moulding rubber & chrome lockstrip--all Sonett		0	39.00
4106	Rear Window Moulding & chrome lockstrip-- all Sonett		0	49.00
4107	RockerPanel Sill Chrome protective plate--Sonett II & V4		0	79.00 pr
4108	RockerPanel Sill Chrome Protective plate--Sonett III 70-73		0	84.00 pr
4109	RockerPanel Sill Chrome Protective plate--Sonett III 74		0	88.00 pr
4110	Cabin Roll Bar, ChromePlated, also chromed braces, Son II, V4		0	160.00 exchg
4111	Cabin Roll Bar, ChromePlated, 70-early72 w/o lift struts		0	109.00 exchg
4112	Cabin Roll Bar, ChromePlated, 72-74 with lift struts		0	109.00 exchg
4113	GasStrutMount under hatch glass, chromePlated, 72-74Sonett		0	48.00 exchg
4114	Replacement glass hatch lift struts		0	55.00pr
4114A	Retainer clips for glass hatch lift struts		0	2.00ea
4115	Rubber Grommet, Fuel Filler-to-body seal, Sonett II or V4		0	19.00
4116	Rubber Grommet, Exhaust-pipe-to-body, Sonett II or V4		0	20.00
4117	Rubber Grommet, Fuel Filler-to-body seal, Saab95/96, '61-68		0	21.00
4120	Key Blank, Ignition, Sonett II & V4		0	4.00ea
4121	Key Blank, Door, Sonett II & V4		0	4.00ea
4122	Key Blank, Ignition, Sonett III		0	4.00ea
4123	Key Blank, Door, Sonett III		0	4.00ea
4124	Key Blank, Ignition & Door, Saab 95/96 up to 1972		0	4.00ea
4125	Key Blank, Ignition & Door, Saab 95/96 1972 onwards		0	4.00ea
4130	Brake Hose, front, 95/96/97		0	28.00
4131	Brake Pad Set, Front, 95/96/97 with Ate SwingingCalipers		0	36.00
4132	Brake Cylinders, Rear, 95/96/97		0	39.00ea
4135	Fuel Filter, HiPerformance 1 Micron filter, 95/96/97		0	9.00
4136	Oil Filter, HiPerformance HiCapacity unit V4		0	9.00
4137	Oil Pump, HiPerformance, HiVolume, HiCapacity unit V4		0	76.00
4138	Oil Pump Driveshaft, Heavy Duty V4		0	29.00
4139	Oil Pressure Switch, Heavy Duty V4		0	19.00

