

#259

September/October

2002

Nines

The Saab Club Magazine



Some people are afraid to
get lost.
Some people look forward to it.

Lost? You're never really lost as long as you're still out there, exploring the road and the new Saab 9-5 SportWagon. Satisfying every whim with its powerful, turbocharged engine, improved ride and precise handling. Not to mention, enough cargo space to carry everything you need when you get there. Wherever that is.

www.saabusa.com



Introducing the new Saab **95**
Starting at **\$33,995***



*MSRP of \$33,995 for a 2002 Saab 9-5 Linear Sedan. Taxes, insurance, title, registration fees and optional equipment extra. Model shown at additional cost. © 2002 SAAB CARS USA, INC.



Fellow Saab Lovers,

2002 is shaping up to be quite a year for those of us who love Saabs: starting with 120 cars, the largest showing to date in Carlisle, PA, back in May; the second Saab Owner's Gathering in North Conway, NH and topped off with the 20th Saab Owners Convention in Cincinnati, Ohio. At the mid-point of the year, we are awaiting the arrival of the new 9-3, amid the tremendously positive press that the car has received to date. For those who were able to be in Cincinnati, we also witnessed the revitalization of the Saab Club of North America (SCNA) and held the first annual meeting & election of officers, hence the reason for me writing this column.

As the newly elected President of SCNA, I thought I would briefly introduce myself to those members not present at the meeting in Cincinnati, along with the officers I will be working with to build the foundation of our new organization. Dan Orzano, President of the Saab Club of Central Ohio has been elected to serve as SCNA's Vice President. Daryle Powers, President of the New England Saab Association (NESA), has been elected to serve as Treasurer, and Mike Meyse, President of the Washington DC Saab Club (WASSAAB) has been elected to serve as Secretary. I am a member and webmaster of the Central Penn Saab Club, and am also a member of the NESA and WASSAAB clubs.

My fondness for Swedish cars is embodied in my current fleet of Saabs, including my '83 900 Turbo, a '93 9000 Aero and the addition of a 2001 Viggen earlier this year. Prior to Saabs, I was very involved with Volvo's; having owned a 1971 1800E, 1973 1800ES, 1973 142 GT, and a 1980 242 GT. I was also a member and Chapter Co-coordinator with Volvo Sports America (VSA is the 1800 club) and enjoyed restoring and maintaining my Swedish iron. In the 90's I married into a well worn 1983 900 Turbo that my wife had purchased new while attending Air Force Pilot Training. My wife always drove the new car and I inherited the "older" car. The car has outlasted the marriage, and I've managed to turn it into a reliable fun car again. I drove the '83 900 to Colorado for the 1999 convention and managed a 2nd Place showing in the Concours that year, and a 3rd place in this years convention. I still enjoy driving this car almost daily and it's showing almost 200,000 miles on the clock. I enjoy being a member of 3 "local" Saab clubs (Central Penn Saab, New England Saab Association, and the Washington DC Saab club) and have for over 3 years, mostly because of the excellent company of the members and the great times that are shared at their events. I currently work full-time for the Air Force Reserve at Dover AFB, Delaware a place were there is hardly a Saab to be found (other than at my house), so participation with the 3 Saab clubs gives me places to go, Saabs to see and really great people to meet.

During the SCNA members' meeting, the Executive Council was charged with the responsibility of drafting and presenting a set of by-laws for the club, to be adopted as soon as practical. The Executive Council held its first executive session immediately after the general meeting to begin work on this project and to set up the framework for SCNA to begin functioning. We expect by the time you are reading this, you may have already found much of this posted on The Saab Network. The Executive Council also decided that a club the size of SCNA will need more than just the 4 of us to get things started and have asked the following SCNA members to serve as interim directors: Jon Hochstetter (Membership), Larry West (Elections), Tom Nelson (Convention), Jerry Danner (Club/Chapter Liaison), and Jim Laman (Public Relations/Communications).

Events the size of our annual convention usually take a full year to plan and successfully execute. Thank you, Phil Lacefield, Jr., for the excellent planning of the 2002 convention, and thanks to all the volunteers, and especially those from the Tri-State Club. We realize that we need to get some ideas on next year's convention & location very soon. We are open to proposals, preferably in a formalized format including dates, pricing and amenities from SCNA members and or Saab Clubs. The Board and Executive Council are open to any formal proposal that can be presented before October 1, 2002. The Board also welcomes input for other Saab related activities, so drop us an email. The Board will also post suggestions, events, and SCNA related information on The Saab Network, the Saab Club's website, and in NINES. I look forward to meeting more SCNA members and getting the club up and running. Thanks for your support now and for the future.

Garry Grimes
 President
 SCNA
ShelbySaab@hotmail.com

Editor & Publisher:
Stephen Goldberger
Managing Editor & Photo Shoot Director
Norma Goldberger

Contributing Editors & Photographers:
Chuck Andrews, Jack Ashcraft, Seth Benglesdorf, Phil Lacefield Jr., William C. W. Lamb, Bob Sinclair, Bruce Turk, Larry West

All material copyright 2002, SAAB Club of North America, Inc. Material may not be reproduced without permission. If permission is given, credit must include the author's name and "NINES, The SAAB Club Magazine". The opinions and views expressed in articles are not necessarily those of the SAAB Club and its magazine, NINES.

Editorial contributions are welcome. All material submitted is assumed to be for publication unless clearly labeled otherwise. Machine readable formats are preferred. We cannot answer every inquiry and reserve the right to edit materials submitted. For those wishing to submit material on 3" IBM-formatted disks, or for E-mail submissions, we prefer an ASCII text file or attachment, but we can read most word processor files.

Photos: Preferred sizes are 5"x7" or 8"x10". Good contrast color photos or full range black and white can be accommodated, no smaller than 3"x5", please. Photos used on the cover will be rewarded with a one year subscription to NINES and must be submitted in 8"x10", with the original negative or transparency, or as a TIFF file with 300 dpi resolution at our 8 1/2 x 11 cover size. For return of photos, include SASE of correct size and postage.

CHANGE OF ADDRESS: Eight weeks notice is required for change of address. PLEASE mail new address and old address, including zip codes, to the SAAB Club at the address below. e-mail OK.

RETURNED CHECKS: There will be a fee of \$25.00 charged for any returned checks.

NINES The SAAB Club Magazine (ISSN 1530-0730) Issued Sept, 2002.

NINES the SAAB Club Magazine is published bimonthly by the SAAB Club of North America. The SAAB Club is not affiliated with Saab Cars USA, Inc. or Saab Automobile AB.

SUBSCRIPTION RATE is \$30.00 per year in the US. Please see the form on the inside cover wrap for complete information.

SAAB Club of North America
 2389 Chestnut Hill St. NW
 North Canton, OH 44720-5822

Phone: 330-497-0346
 9am - 9pm Mon - Fri Eastern Time
 Fax: 413-740-5583

email: nines@neo.rr.com
 WEB SITE: <http://www.saabclub.com>

Periodicals Postage Paid at Canton, Ohio, and at additional mailing offices.

POSTMASTER: Send address changes to NINES, 2389 Chestnut Hill St. NW, North Canton, OH 44720-5822.

Features

New 9 ³ Sports Sedan <i>by Stephen Goldberger</i>	8
Attending a Press Launch <i>by Norma Goldberger</i>	11
Car Control <i>by Gordon Booth</i>	27
Nokian NRW Review <i>by Stephen Goldberger</i>	36
Nokian WR Introduction <i>by Stephen Goldberger</i>	37

Saab Clubs

North American Saab Clubs and Contacts	16
Clubs Events and Calendar	
<i>NESA Saab Owners' Gathering, Northeast Ohio Gathering, Adirondack Saab Run, SAABtoberfest, Swedish Car Day, NESA Officers Meeting, 5th Annual Tech</i>	21

Departments

President's Corner <i>by Garry Grimes</i>	3
Letters to NINES	5
My Saab	6
Professional Perspective <i>by Chuck Andrews</i>	
<i>Tenth Anniversary, Diagnosis Impossible</i>	15
Ramblings and Demands <i>by Phil Lacefield, Jr.</i>	
<i>And Then, There Actually Was One</i>	18
On the Column <i>by William "Chip" Lamb</i>	
<i>5 Minutes Up Late</i>	19
Saab News	
<i>2003 Saab Pricing, Sales, Certified Pre-Owned, Press Reactions to the New 9³ Sports Sedan</i>	20
Classic Corner <i>by Larry West</i>	
<i>Classic Convertible</i>	28
Tech Talk	
<i>Uhltronics Triad Cellphone Adapter</i>	30
Shoptech <i>by Jack Ashcraft</i>	
<i>The Primary Circuit 1968-69 Saab Sonett III</i>	32
Saabs in Competition	
<i>2002 Pikes Peak Hill Climb</i>	40
Saab Swap	41
Looking Out (from under NINES) <i>by Stephen Goldberger</i>	42

Front Cover: New 9³ Sports Sedan.

Photograph by Stephen Goldberger

Cover Wrap: New 9³ Sports Sedans.

Photograph by Stephen Goldberger

Road Trip

Our first road trip in our Saab 9³ was from Los Angeles to Chicago to visit my brother, by way of Houston. 2 days, 1 ticket (85 in 75mph, woman trooper in New Mexico), 1300 mile later and we're in San Antonio, TX. We started from Los Angeles on Tuesday night, with the plan of spending Memorial day weekend in Houston. The 9³ is doing darn well. We maxed out at 29.5mpg according to the SID (*Saab Information Display*). The car topped out at 125mph in 4th gear between El Paso and San Antonio. The front Falken GR-Betas are down to the wear bars; I hope they hold out until Chicago! I'm VERY glad we picked the 9³ over the Miata.



Tony Chen's 9³ and friend.

I learned to hate Momentum Saab in Houston. I broke a return fuel line after traversing a parking space concrete stopper thingie. Saab Roadside Assistance refused to tow the car until the local Houston Fire Department "inspected" the 9³ for possible fire hazard. How many firemen does it take to put out a Saab which is not on fire? Four, including the local captain. Quite exciting.

It was Monday (Memorial Day) afternoon. Momentum was the only Saab service in town and it closes at 6pm. The car was in lot by 5pm but NO ONE would help us. Earlier on the phone, I told 'Steven' the service writer we were headed to Chicago, after driving from LA to Houston. He simply told me I was SOL until Wednesday.

We were saved by the nice Israeli gent who towed my car. He drove us to Pep Boys and waited while we scrounged for parts. He then took us back & we went to work on

the fuel line. A 5/16" metal union, 4 clamps and 30 minutes later, we were off to Chicago.

By comparison, Perillo Saab in Lincoln Park, Chicago was terrific! They knew I was on a tight schedule and did the free 20K oil change/quickest inspection in 1 hour on Wednesday morning. George, the service tech, kept drooling at the Brembos (aftermarket 4-piston brake calipers) and kept on asking if I had a 'bigger' turbo. I told George if I ever get the turbo, I'll be sure to trek on by Chicago.

Tony Chen
Los Angeles, CA

"Momentum" is no longer the Houston Saab Dealer. "Performance Saab of Houston" acquired the franchise shortly after Tony's visit. -Ed.

"New 9³" vs "C 9³"

We REALLY need to come up with better names!! As the editor of the most respected Saab magazine (how's that for sucking up?) it is your duty (if you choose to accept it) to adopt proper terms for the "new" Saabs. If anyone calls the 2003 9³ the "NG 9³" I'll rip their vocal cords out! Scott Patterson has said that he receives MANY questions about what "NG900" stands for. Most people automatically assume "no good".

My feeling is that we should either refer to the new models by their internal platform codes "440", or else by whatever marketing term that Saab comes up with. Preliminary indications show that Saab is calling it the 9³ Sports Sedan. Thus, the obvious abbreviation is "9³ SS". A Sport Wagon would be the "9³ SW", etc.

I have some posters of the 1999 9³ that call it the "All New 9³". Uhhh... right, I wouldn't expect them to call it the "Warmed over 900"!

Kevin Quigley
Marlborough, MA

It's not the Editor's decision but the consensus of the subscribers that determines what to call the cars. Assuming that Saab keeps the nomenclature through a number of generations, distinguishing them by their internal code would be convenient and would also be consistent with the practice followed by other magazines; e.g.,

Roundel, the BMW CCA magazine. The internal code for the 2003 9³ Sports Sedan is 440, the 2004 Convertible is 442. The 9⁵ sedan's internal code is 640, and the wagon is 641. A 2003-on (until the next generation) 9³ Sports Sedan would become a 440 9³. The current generation 9⁵ would be a 640 9⁵ for the sedan, or a 641 9⁵ for the wagon. Issues related to both would refer to a 64X 9⁵. -Ed.

Backwoods "Lift"

This is how we work on a 9000 exhaust in Vermont. This is the first try with using the backhoe:



At this point it came crashing back down. My dad and I decided that it would be much easier with the front bucket. Our results improved and the car didn't crash back down.





I do wonder if my dad needed to change his undies after the front wheels came off the ground though. The pictures don't do it justice; at one point the tractor's wheels were about 6 feet off the ground. Getting the exhaust off only took about 3 minutes! Overall I'm very glad that I didn't have to climb under the car to do the work.

Actually, it was sort of payment to my dad, who is far from being a Red Neck. I was keeping the car at his house, and he has that big old backhoe. He is a film maker, and sitting inside editing films all day makes you go kind of stir-crazy, I guess. For some time he really wanted to squash the 9000 sitting out there. When I needed to get the exhaust off the car, I realized it was either let him flip it, or he would eventually squash it. Plus it really was lots of fun to do.

Noah Dater
Burlington, VT

My Saab

My Saab was a former Saab Corporate Executive's car which I purchased in the early 1980s and have owned since. I also was working for Saab in the mid-80's when the AirFlow kit rage was at its peak. We (I was in the parts and service division at the time) were trying to persuade our management to offer various accessories for the 99, even through it was no longer being sold in this country. To make the case, we redid this 99 as an "Accessory Show Car," including a

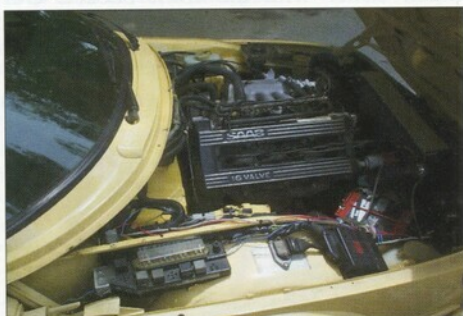

16 valve Twin Cam "S" engine mounted in Tom Letourneau's 1979 99.

never available in the USA "Factory SAAB-99 AirFlow Kit." The kit was installed and the car was re-sprayed at the same time. It has a factory trailer hitch that is excellent for any light to medium duty towing and with the more powerful engine and 5-speed trans should not skip a beat if and when you need to use it for any kind of towing. A factory SCCA Showroom Stock roll bar was installed, along with a mechanical "Halda Speed Pilot" for rally use. It also has a set of very rare and hard to find SAAB - Shelby American Mag Wheels installed. In anticipation of having this vehicle included in that year's factory (USA) accessories catalog, the car was professionally photographed, etc., and was featured on the cover of "NINES."

Management declined to import the AirFlow Kit for a number of reasons, one of



Custom paint including body colored bumpers, and matching Shelby American alloy wheels.

which was not wanting to sell accessories for vehicles no longer being imported. Another reason was the fact that a Saab 99 had never been crash tested with an AirFlow Kit installed. That was the best of all the reasons given.

I've had the car ever since. In the early 90's it burned a valve, and I parked it in my garage until I could decide what I really wanted to do with it. I decided to install a 16-Valve Twin Cam engine with a 5-speed transmission. My concern was that the conversions that had been done and reported in the Saab Club Magazine involved butchering the firewall/front bulkhead. A very good friend, who owned a Saab dealership here in Rhode Island and was also an Engineer by profession, felt that by creative use of the many different interchangeable parts that have been used on Saabs he could perform this conversion and have it look just like stock. I was selling



European Airflow Kit for the 99 was never imported into the USA.

dealership computer systems at the time, having left Saab Cars USA when they moved to Atlanta. While I was negotiating with a Saab dealer in Maine, his wife totaled out her demo, a 900S with a 5-speed. I told him that if he would add the engine (including fuel-injection system) and trans to his last counter-offer, we would have a deal. He went for it and I lugged the assembly back to my Saab dealer here in RI.

We began the conversion in 1997. After setting the engine and transmission in the car, we fabricated the mounts and located all the parts necessary to do the conversion. Then we removed everything and I took the Saab to a body shop to have any rust repaired and to have the car re-sprayed, including the engine compartment. Then the vehicle went back to the Saab dealership. Since the beginning of 2000 we worked sporadically on the project, completing it this spring. The car uses the original 900S "Electronic Fuel Injection System," not a retrofit CIS-System as many other conversions have been done. It has been professionally wired, with all the necessary and proper components and relays. We also rebuilt the entire brake system and had a custom stainless steel exhaust system made for it. You should hear the exhaust note on this baby, and does she rev. That's about it; that is the entire history of this 2-owner 1979 car.

Tom Letourneau
Cumberland, RI

Beginning Thursday, September 26, this car is scheduled to be put up for auction on Ebay. -Ed.

HAKKAPELIITA 1 SAVES LIVES



nokian
HAKKAPELIITTA 1

Eco Stud System

The studdable Hakkapeliitta 1 has taken winter tires to the next level of safety. Its patented Eco Stud System and self-cleaning arrowhead tread design significantly improves traction and lateral grip for better handling and safety.



Feature	Safety Benefit
Locking Sipes and Angled Tread	<i>1000's of biting edges creating unparalleled traction</i>
Arrowhead Tread Pattern (directional)	<i>Unique tread positioning effectively expels water, snow and slush while providing "uncompromised" lateral grip</i>
12 Row Patented Eco Stud System	<i>Better grip and responsiveness on polished ice while giving a smoother, quieter ride</i>
Jointless Nylon Belt	<i>Helps prevent tread separations while providing smooth, comfortable ride</i>
Severe Service Emblem 	<i>Exceeds new government snow condition regulations</i>



nokian
TYRES

Where Safety Begins

www.nokiantyres.com



Saab's Best Sedan Ever?

This past July we were invited to join 34 other journalists from North America at the Press Launch for the New 9³ Sports Sedan. Saab did not have to ask twice. The program included technical and marketing descriptions of the new car, driving experience, and static displays which were attended by working engineers. The static displays included safety and structure, with Roger Malkusson; engine and transmission; with Mats Reijark, Martin Widmark, and Mikael Westerberg; suspension, with Ekkehardt Schwartz and Krister Fredén, and "infotainment," with Patrick Lundblad and Johan Wiren. Michael Mauer and Amer Mahmud were on hand to discuss the design, and Peter Lundin and Christian Gustafsson explained accessories.

The driving experience included an afternoon drive over a route that included tight, twisting lane-and-a-half country roads, open two lane country roads, and somewhat crowded expressway driving, along with an opportunity for brief "on your own" touring the next morning. The vehicles available for testing included 2.0t (175 hp) models with 16 inch wheel and tire package and "Arc" interior trim in automatic and 5-speed manual configurations, and European Aero models in automatic and 6-speed manual configurations. The North American "Vector" models will be the same as the European "Aero" models we drove, while the "Arc" models we drove are essentially the same as North American "Linear" with the Launch Package (see NINES #258, the SCUSA web site, or your dealer for specific model details).

To start at the conclusion: from the "B" pillar forward Saab's new 9³ outclasses anything the company has ever produced. In its driving properties, safety systems, power train, and front seat accommodations it meets or exceeds promised excellence in the press releases. In the rear seat and trunk areas the 9⁵ manages to hold an edge, not only in the amount of space, but also in the 9⁵ seat's "flip fold" that approaches a flat floor, versus the 9³'s folding backrest only.

Contributing to the excellence of the result is that Saab's engineers have participated in the design of every aspect of the new car from its inception. This car is "completely new," including a completely



Red 9³ Aero Sports Sedan at the International Press Launch.

new engine, transmission, body and chassis, a feat not performed by Saab since the introduction of the model 99. Saab's influence is seen throughout the engine and body structure, while some of the suspension details show how Saab has benefits from the contribution of other divisions within GM.

Styling is in the eye of the beholder, and we think the front end is drop-dead gorgeous. The character lines in the Saab hood evolved from a separate "hood and fenders" on the very first Saab prototype to "hood and fenders styling" on the single piece hood of the 92, 93, and bullnose 96, to slight crease lines on the NG900. They have restored prominence on this car. The front is rounded in both the plan view and the side view, giving an aerodynamic appearance to go with the car's 0.28 drag coefficient, and the rounded side profile is reminiscent of the "bullnose" and "longnose" 96. We find the back end less distinctive, looking contemporary and attractive, but "ordinary." For example, the "concave/convex" rear window treatment, which has been a hallmark of Saab sedans since the 99, is absent. The rear door window line has been contorted to hint at Saab's traditional "hockey-stick" character lines, but the shape is really more like the model 92 and 93, which predates the introduction of the "hockey stick" styling. Some of the look is generated by stuck-on moldings and the door and window shapes are at odds with each other.

The interior is a thoroughly modern interpretation of the theme introduced on the Classic 900: an asymmetric dash which curves to match the driver's reach, with lighting controls on the left and radio and

heating controls on the right. Today's "radio" controls include the integrated telephone keypad, navigation screen, car computer, and information display (SID). The array of buttons and knobs seems imposing at first glance, but those needed while actually driving the car are either duplicated on steering wheel controls (radio volume, station selection, and CD player control), or are distinguished by shape (volume/balance control) or location (night panel, heating controls, station scan/select).



Dark phase 9³ Aero interior trim.

Heater and air conditioner controls carry over the general layout of the 9⁵ and previous 9³. The test cars had sharp and legible color LCD screens, but the navigation system was not yet functioning. The SID, Automatic Climate Control (ACC) display, and monochrome information screen in the Linear model are now green, like the dash lighting.

The front floor is not cramped as it is on the NG900/Classic 9³, and the pedals are



Twin tubular A-pillar structure is much stronger than a single tube structure.

correspondingly spaced wider apart. Seating and trim are quite satisfying. The standard front seats, used in Linear and Arc trim, are comfortable and provide plenty of lateral support during spirited driving. The sports seats, used in the Vector trim, feature more prominent side bolsters, a trim piece in contrasting color, and are leather across the back and sides as well as the seating area. The rear seats are comfortable and supportive. Rear seating space is adequate,

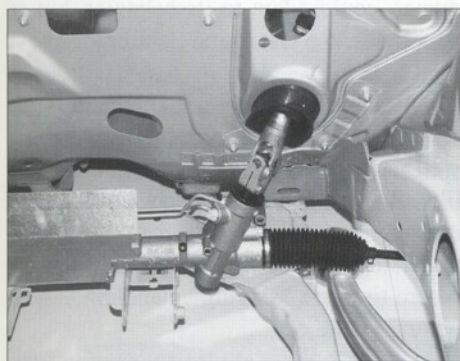

Steering rack mounted to the aluminum subframe. Note lower engine mount.

but, as expected in a "compact sports sedan," not as generous as in the 9⁵. The

interior is available in two color phases: dark, with charcoal leather and grey carpeting and door panels, and light, with "parchment" color leather, door trim, and carpeting. The parchment color is a "cooler" tone than the tan used in the 2002 and earlier 9⁵ and 9³ models. We think it will show dirt less than the warmer tone beige does.

When driving the new car, the very first impression is the smooth, cushioned ride. This car has the same feeling of smoothing out the sharp impacts as the 9⁵. Schwartz and Fredén said that ride quality is influenced mainly by the longitudinal (up and down, forward and back) bushing stiffness, and longitudinally the bushings are quite soft. Handling, they say, is influenced by the lateral (side to side) stiffness, and the bushings are stiff in that direction. The new body is claimed to have more than twice the torsional stiffness as the car it replaces, and is much stiffer in bending modes as well. The absent "body flex" can be put into suspension and subframe mount bushing compliance, isolating the body from road shocks without degrading handling. Engine noise is muted,

vibration is all but absent, and wind noise was non-existent on any of the cars we tried. The "pendulum" engine mounting is said to use the body's longitudinal stiffness to balance the engine torque, a direction in which the body is very stiff. Reimark said proudly that the body is so stiff that the engine idle speed can be set below the first body resonance, the first time Saab has achieved this.

Performance wise, the 2.0t (175 hp) is ample, with the automatic transmission allowing full engine torque to be produced in all gears. The 2.0T (210 hp) engine is noticeably quicker, and somehow felt even smoother than the 175 hp version. The wider range of gear ratios in the 5-speed automatic versus the 4-speed it replaces allows the car to pull "off the line" with greater authority while maintaining quiet and fuel efficient low rpm cruising. Turbo lag is a fact of life, and flooring the accelerator while cruising in an off-boost state means waiting for a response. The automatic transmission controller holds the car in gear until there is enough boost pressure to provide some thrust, and then downshifts. This accentuates the feeling of

SAABPARTSDIRECT.COM

"Your Direct Source"

New, OEM, Genuine, Rebuilt and Aftermarket Saab Parts

GUARANTEED LOWEST PRICES!

FREE SHIPPING on orders over \$40

- * Brake Products
- * Cables
- * Clutches
- * Cooling/Heating
- * Electrical
- * Engine
- * Filter/Emissions
- * Fuel Systems
- *Steering/Suspension



WE'RE THE SAAB PARTS EXPERTS, SO YOU DON'T HAVE TO BE!

ORDER ONLINE: WWW.SAABPARTSDIRECT.COM

or **CALL TOLL-FREE: 800-871-3619 M-F 9am-6pm**

Fax: 631-863-2760

E-Mail: sales@saabpartsdirect.com

New 9³ Sports Sedan

delay, but it also prevents the car lurching back and forth from downshifting before the engine is ready to provide thrust. Adding some throttle to build boost pressure just before flooring the throttle resulted in a quick, smooth downshift and immediate acceleration.

So-called torque steer is the bane of powerful front wheel drive cars, especially in magazine reviews, but the new 9³ displays almost none. According to the engineers, the tendency for FWD cars to "dart off in a side direction" or "tug at the steering wheel" during strong first and second gear acceleration is caused primarily by deflection in the front end geometry. The suspension and steering rack are very stiff in this car, holding the wheels in the correct alignment despite the torque. Saab specifies the largest commonly available piston rod in the front struts: 25mm (1 inch) in diameter, to maximize rigidity.

Another contributor to "torque steer" is the "Ackerman correction" in the steering. When turning a circle, a car's inside front wheel turns a smaller circle than the outer wheels, so the inside wheel should turn a sharper angle for the most efficient rolling. Steering geometry which achieves this is

called "Ackerman", and it makes the car more susceptible to "darting" due to an effective "toe out" when the steering is turned.

"Full Ackerman" is also detrimental to cornering response. At speed, the outside front wheel is more heavily loaded and is thus capable of providing more turning force without slipping. With the inside wheel turning more sharply, as the Ackerman correction requires, the inside front wheel has the greater slip angle. Saab's steering geometry undercorrects to avoid these problems.

Every 2003 automatic transmission Saab will be equipped with "Sentronic" control, a feature that purports to combine "manual transmission control" with "automatic transmission convenience." Sentronic control allows the driver to either leave the car in "automatic" shift mode, or to select an individual gear by moving the lever to the left, then forward to shift up or back to shift down. During most of the twisted road driving, we used the Sentronic feature with the transmission set to 3rd gear. If you had a conventional automatic, you would achieve much of the same effect by selecting "3". The main difference occurs if one slows to

such an extent that 3rd gear is not appropriate. In both cases, the transmission shifts down to 2nd gear, or even 1st gear, but then when speeding up, the Sentronic stays locked in 2nd (or 1st) until you either approach the engine's rpm limit or you manually shift back up. The conventional control would shift back up to 3rd gear, but wouldn't shift beyond that. On a track, with predictable and repeated gear changes, Sentronic would be great. One who drove the Sentronic extensively, such as an actual owner, could adapt to its behavior, but as neophytes, we just found Sentronic annoying.

What is definitely not annoying is the way the car handles. Steering is weighted well and accurate. Initially the new car feels like all Saabs, but as the suspension loads up and one is expecting the car to begin to understeer, it doesn't. Even to the point where tires are "singing", handling is near neutral.

The Aero model clearly benefits from having lower profile, more aggressive tires, but there seemed to be a lot less difference in the handling between the Goodyear NCT

Continued on Page 38

DO IT THE RIGHT WAY!

Use our heavy gauge sheet metal to rebuild your Sonett! All parts come with illustrated step-by-step instructions. Call for prices



Learn about maintaining your V4 engine! 100 pages of overhaul, tune-up, carburetor, specs & more

\$59.00
plus \$5 S&H





Jack Ashcraft's
ORPHAN SAAB V4 PARTS
Ph 541-779-0731
email: jackashcraft@prodigy.net
2030 Grey Eagle Dr., Medford, OR 97501

FREE CATALOG!

Attending a Press Launch

by Norma Goldberger

I had the great pleasure of accompanying husband and joining the other press at the launch of the 9³ in Stockholm and subsequent tour of the SAAB factory and museum in Trollhättan.

Our hotel rooms had no air conditioning, which is typical in Scandinavian countries since the temperatures cool down at night. We opened our windows for cool air. There were dark curtains to block the light, but propping the window open for air pushed the curtain aside. Dusk happened around midnight and bright dawn, with screaming seagulls, around 2:00AM. Seagull screams, light accompanied by a change in time zones required a bit of adjusting. The lobby of our hotel had Saab items for sale and I gifted Steve with a blue stuffed Saab SportWagon that turns into a Moose. He then gifted himself with a Saab Turbo watch.



The Royal Park Hotel at Frösunda was once the barracks for the palace guards.

We were granted access to many of the engineers and designers of the new 9³ who



Tourist boats provide an excellent view of Stockholm's archipelago.

answered any of our questions and patiently showed us sections of the 9³ explaining why their innovations were innovative. Not being technical nor in possession of our digital camera, I discovered the press room where computers were connected to the internet and read that our daughter met up with a fox while walking our dogs.

After touring the center of Stockholm by Ferry, we were given a non alcoholic lunch with a variety of herrings such as herring in crayfish sauce, curry sauce, smoked mussels on tomato and lettuce, crisp flatbreads, and smoked reindeer sandwiches. Then we were presented with keys to test drive the 4 models of the 9³: manual or automatic, Arc or Aero, which I refer to as regular and souped up, respectively. *(The press launch Arc models were fitted with the 175 hp engine. In North America, Arc and Vector will be fitted with the same 210 hp engine used in the European Aero models. The Linear will have the 175 hp engine used in the Arc models we drove. -Ed.)*

We were given a map with Swedish highway exit names and set loose to drive up curvy country roads. It took one wrong exit and a subsequent tirade from the Editor for me to get the hang of the Swedish names and kilometer readings on the map. The names were so unusual I couldn't remember them without staring at the map.

When I looked up by the time I read them I forgot the name I was looking for. I did finally figure out a working navigational system and we proceeded up the highway to the rural roads. We drove, for example from Frosundavik toward Vallentuna, turned on Rosersberg and then to Almunge/Skanela. The names don't look so difficult now, but when traveling 120 kilometers per hour the names whiz past.

The scenery north of Stockholm reminded me of northern Ontario with the coniferous trees and fresh green smell. The crossing Elk or Moose signs however

were different, as were the numerous dairy or horse farms along the route. One farmer looked very annoyed as he wrote down all the license plates of the Saabs whizzing past his farm.

All the 9³'s I personally drove hugged the curves tightly and stopped quite adequately. I found the steering tight and the acceleration great. I would have been happy in any of the models. Fortunately I wasn't the driver when a motor scooter drove off of a curve in front of us prompting us to stop suddenly when he dismounted and walked back to the road straddling his scooter. Fortunately for us, all the Saabs behind us also stopped abruptly. On one 2 lane curvy country road, another press car tried to pass two motorcyclists who blocked her repeatedly when she went into the passing lane. These cyclists would then

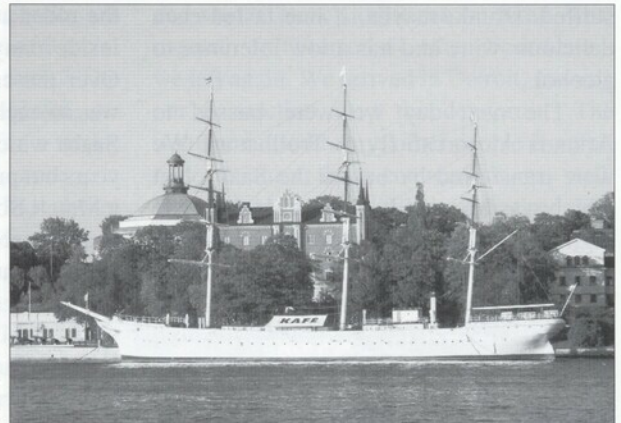

Tall ship used as a youth hostel.

slow down after she returned to the correct lane immediately behind him. We were behind her. After a distance the cyclists turned onto a different road and we were able to continue unimpeded.

Dinner after the test drive was at a wonderful Swedish restaurant across the harbor from a "tall ship" converted into a youth hostel. We had a multi course dinner. Saab Museum Curator Peter Backstrom sang a typical Swedish "let's drink" song as we tasted the schnapps. After a few drinks, and a repeat of the song each time, many of the press bragged about how fast they could accelerate the new Saab 9³'s from 0 to 85 in seconds, or how they took the country road curves in excess of 135 MPH however that translates into kilometers. Husband has decided I need to travel with someone else in the next test drive so he too can tempt fate.

Attending a Press Launch

We were treated to delicious food an example of which was a 1st course of herb and garlic cured Baltic herring served on crisp rye bread, with prawns smoked salmon, egg, horseradish and dill in mayonnaise on toast, a second course of Tuna tataki with cucumber spaghetti and trout roe, Gravlax with horseradish, roasted pepper and mustard sauce, a 3rd course of duck liver terrine on crostini with preserved cherry, green asparagus with Vasterbotten cheese and roasted reindeer, vodka cured fillet of beef with roasted summer carrots and spring onion, grilled corn fed chicken from Bjarred with sauce vierge and roasted summer vegetables and a dessert of cheesecake with strawberry salad, chocolate truffle and coffee. Each course was accompanied by a wine if desired. All of the portions were very small which meant one could eat everything and not feel overly stuffed. Drunk, maybe, if one tasted each delicious wine and has a low tolerance to alcohol.

The next day we were bussed to Arlanda Airport to fly to Trollhattan. We were transferred by bus to the Saab plant which was large and very visible from the highway. No pictures were allowed in the plant itself.

The Saab factory was on partial summer vacation. There were a few workers present. It was as immaculate as the London's Chocolate Factory which I just toured here in N Canton Ohio. There were a few male and female workers dressed in Saab shirts with what looked like Saab issued shorts or long pants. We rode a tram through the factory. Particularly impressive to me was not only the safety features of each section for the workers but also the 90 degree turn the cars make when the workers install parts onto the bottom of the car. It was explained that having the cars hung on their sides was ergonomically better for the workers. Each operation was checked completely by scopes before the car was sent for the next stage in their construction.

From the factory we were bussed to the Saab Museum. Peter Backstrom the curator accompanied our group explaining many of the older antiques and permitting us to sit inside many of them while we took pictures. Over the cars hung a Saab aircraft. There was an enclosed glass shelf of toy models of Saabs which were sold in Europe over the years but probably not in America. One was a Match Box Saab which I have never seen at an American flea market at stands which feature Match Box cars.

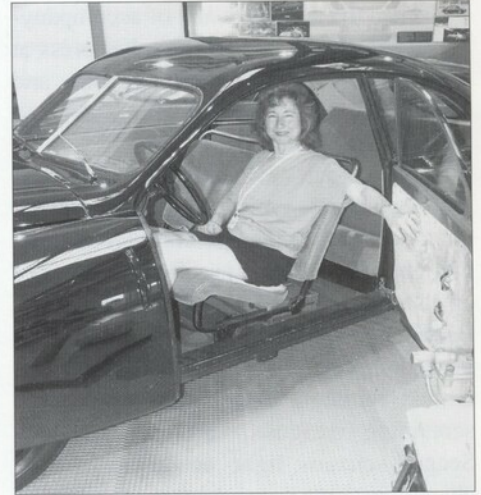

UrSaab, the original prototype, in the Saab Museum.

We left Sweden for a brief frantic tour of Oslo where we saw every museum in 1 day that was humanely possible. Norway sells a 1 day pass which includes all museums, art galleries and public transportation. We zoomed through many Viking ship museums, the Kon-Tiki Museum, the Norwegian Maritime Museum and the Norwegian Resistance Museum. Apparently Hitler thought America and England would enter Europe through Norway during WW2 and so Hitler sent 400,000 soldiers to

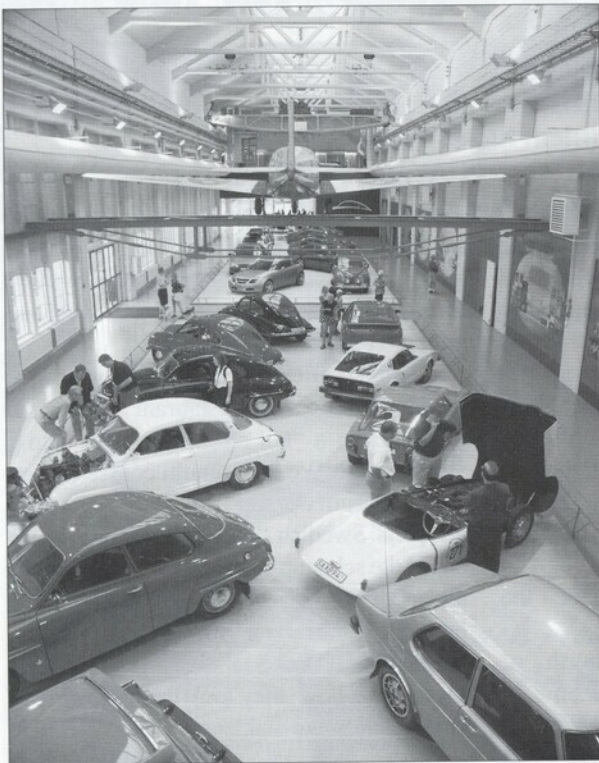

The Saab Museum in Trollhattan.

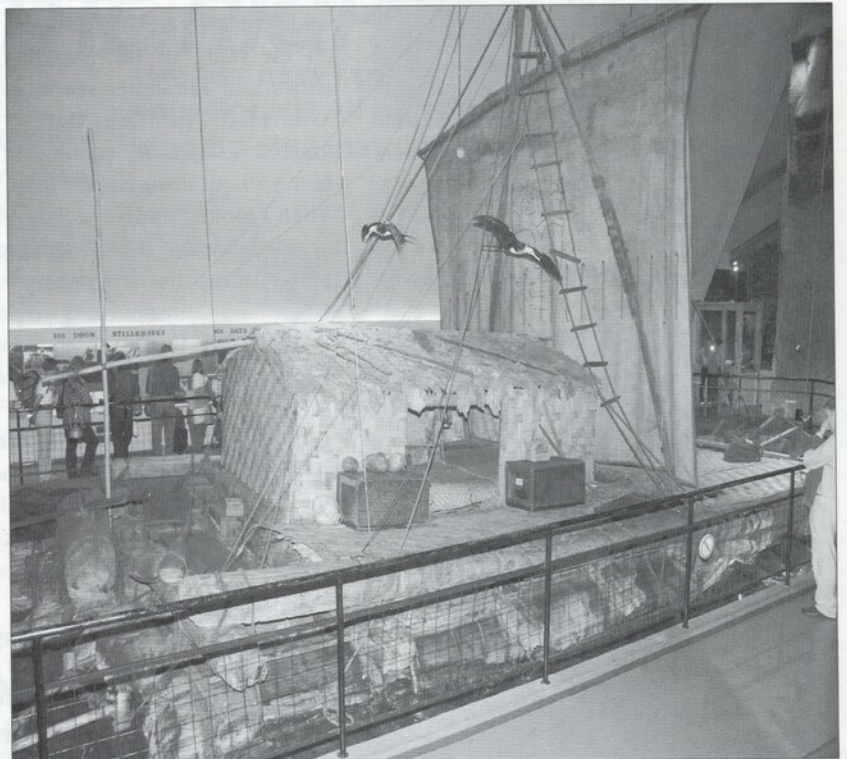

The Kon-Tiki Museum in Oslo.



The Norwegian Ship Museum outdoor display of tall ships.

occupy Norway to prevent an invasion that never happened. Our lunch consisted of eating freshly caught and then quickly boiled shrimp on the pier by the Norsk Folk Museum. When the Museums closed we took the tram to the site of the 1986 Winter Olympics ski jump, where we ruined our legs by walking to the top of the Observation tower and then walking down again. Since dusk in July falls at midnight we finished our day at the Vigeland Park, where stone and bronze sculptures of the passage of life reflected in 16 foot human sculptures still affects me deeply. One of the 192 sculptures, for example is of a young couple embracing while their toddler throws a temper tantrum by their feet.

From Oslo we flew to Amsterdam, which also sells an unlimited public transportation and museum pass to tourists. After the ski site in Oslo the evening before, we didn't do quite as much touring. We did



Amsterdam is a city of canals.

tour the old Jewish city section with a tour guide from the Jewish museum in a torrential downpour. Residents told us that it has rained for 9 months every afternoon and that this was typical for a "mild" sea climate. We were particularly affected by the Dutch Resistance Museum which documented in chronological order life from pre WW2 to after the war. The Jewish Theater Memorial and Jewish Museum's touring exhibit of the Russian killings in Chechnya were also gut wrenching.

We stayed in a Bed & Breakfast with some trepidation since we knew we would have to share a bathroom with another couple. Most hotels would not rent for a 2 day weekend, having a minimum of 3 days' stay to qualify for the "weekend rates." The other couple turned out to be delightful, our age, and the life style writers for a major Canadian newspaper. They were on assignment writing articles on Indonesian Restaurants in the Netherlands and in France. In addition the wife wanted to see her extended families' names in the Memorial Book of Dutch Jews who perished which she found at Anne Franks' house. Only her mom of her extended family escaped.

Amsterdam is like the center of a bicycle wheel in that the train station is the center, and public transportation, buses, trams, subways, and canal boats either go to the train station or loop in circles around the diagonals. The train station is known as the worst place for pickpockets in the world. The narrow streets with little shops including coffee houses also had huge banners up telling tourists to beware of pick pockets. We were careful. (Someone on our Saab group had

her passport and airline tickets stolen from the Stockholm airport.) We were fine. But someone did come from a wall heading for me and both husband and I turned and glared at his eyes as we walked on. He stopped inches away swinging this hands into each other. I recommend not carrying a purse. I suspect many of the tourists exit the coffee houses less than fully observant of potential danger.

Many British, Scottish and Irish tourists fly to Amsterdam for the long weekend (average cost for them about \$60.00). They were so friendly but so hard to understand. Were we all speaking the same language?

We returned on a flight which announced after 1 and 1/4 hours that it was having mechanical difficulties and would return to Amsterdam where they were sure it could be fixed. The Lebanese-Palestinian beside us looked up from reading the Koran and said "Thank God it can be fixed. That means it isn't a terrorist". After about 4 hours we left again. We arrived in Detroit, missing our connection in a thunderstorm. The weather caused many other people from all over to miss their connections as well. Detroit airport was filled with tired and disgruntled people. Exhausted, we graciously accepted the airline's offer of a hotel after our next flight had a "center of gravity problem" which could only be rectified by removing passengers.

We have hundreds of digital pictures of our trip. Perhaps once #259 is in the mail husband will put them up in a site and you can check out the pictures which interest you.



Northwest Airlines owns a very special Saab.

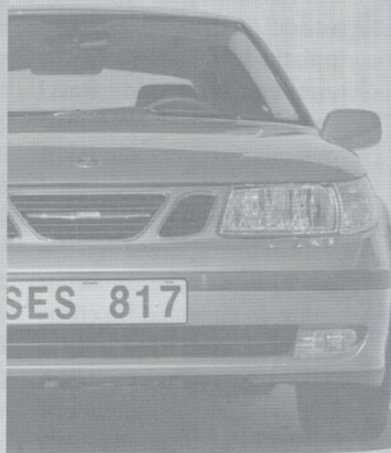

Meyer Saab

2670 480th St. McIntire, IA 50455

Exclusive SAAB Dealership since 1964

1-888-722-2246

www.meyersaab.com

- **Authorized Dealer**
- **Genuine SAAB Parts at Wholesale Prices**
- **Technical Support on all SAAB models (vintage to new)**
- **Certified Used Vehicles**

Two Locations to Serve You

IOWA CITY SAAB - 4165 Naples Ave. SW Suite #3 Iowa City, IA 52240
Authorized SAAB Service Facility 1-888-590-4340

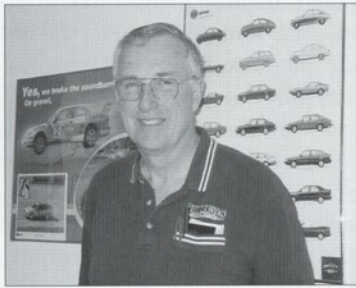

Tenth Anniversary

This issue marks ten years that I've been writing this column in NINES. "PROFESSIONAL PERSPECTIVE" was introduced in the 8-30-92 issue. I don't know where the ten years have gone! At the time I started writing for NINES I'm not sure if Tim Winker, the former editor, "allowed" me to write or if I coerced him in some way. I'm reprinting the introduction to review where we have been and what we are about.

Congratulations! You are about to be introduced to a column that will reflect a professional's view of past, current and future concerns of you, the Saab owner.

We intend that this column will reflect our opinion, based upon our training and experience. "And what gives you the right to make these proclamations," you might ask? We are beginning our 20th year of business as an independent Saab repair shop. We are not huge, usually about ten people dedicated to servicing and selling only Saabs. We are small enough to know most all of our customers well enough to know their concerns and joys of Saab ownership. We are ASE certified, PPG certified, etc. We are equipped to handle any and all problems.

That's the WHY of writing this to help address some of the many questions we are asked over and over year in and year out. For example: how do I choose a mechanic or body shop? What do all these certifications mean? What procedures are okay environmentally? Which repairs, parts and cars should I stay away from? Are high performance parts okay? What types of paint should be used on my car? What is four wheel alignment? How should rust be repaired? Does a 16-valve really fit a 99? What tires should I choose?

These concerns just scratch the surface. Again, our discussions of these and other topics will be based on our opinions. We live in the Upper Midwest where our problems may be different, but solutions should be relevant to everyone.

At the beginning we will not be answering any direct questions from the readers of NINES. If there are questions concerning the content of articles presented, we will answer those.

Education is the key to making wise and satisfying purchases. We will present reasons for knowing about your car and knowing who should maintain it and how. Restoration may be reflected as we see more and more interest in the vintage cars.

So much for introductions — we look forward to expressing our "professional perspective" in the next issue.

Since that 1992 introduction, our shop has grown to over 26 bays including the Service Department and Body Shop. Over the years, I have changed hats (as many small business owners do) from being a certified painter in our body shop to owner,

900 - 9000 - 9³ - 9⁵



English - Swedish Car Spares Ltd.

345 Branch Drive SW - Alpharetta, GA 30004

-Largest collection of Recycled Saab parts in the South

1-800-241-1916

770-475-2662 Local

770-475-2663 Fax

<http://www.english-swedish.com>

Visa - M/C

Disc - Amex

COD

UPS - Motor Freight

New Arrivals Daily

Fair Pricing

Call for Quotes

Now carrying Volvo parts, too

Professional Perspective

manager, car buyer and seller, semi-truck driver of our car transporter, editor-in-chief of our company's quarterly newsletter and I oversee and administrate our award-winning website. In addition, I am still a contributing editor at NINES. (For which we and our readers are grateful! -Ed.)

Has this changed my perspective? Of course! I'm ten years older and see/oversee hundreds of Saab problems and cures each year. Do I still have a perspective? I sure hope so! I'll keep expressing it as long as I'm able. Did my column live up to the introduction? I'd like to believe that it has. As I reviewed ten years of columns all the issues that I related to in my original introduction were addressed. There are new things coming continually that I have hopes of addressing in the coming years. Saab is on the move and I hope to keep up with the move.

One of the current and frustrating issues is the information barrier that has been erected by the new car manufacturers. The Associated Press column that I have included was brought to me by a friend and hits the problem pretty squarely. It was nice that A/P took Ernie Pride's picture with a Tech II while working on a couple of Saabs.

Read on and note how many dollars the car dealers are making. Do you want them to control even more of the market or will our free enterprise system of "competition" be the rule?

Diagnosis Impossible: Independent repair shops often can't crack code

By Nedra Pickler (Associated Press)

ARLINGTON, Virginia (AP) -- At least a couple of times a week, mechanic Ernie Pride tells customers at his independent repair shop he can't fix their cars because he doesn't know what's wrong with them. Go to the dealer, he advises. He has the experience and knowledge to service vehicles but lacks the closely guarded information needed to diagnose problems with today's high-tech cars. Automakers refuse to make much of it available to independent shops that compete with higher-priced dealerships. The practice is raising hackles in Congress and a vigorous defense by the industry.

Figuring out what's wrong with an automobile is no longer as simple as poking around under the hood and examining parts.

Computers control many modern vehicle systems, including the engine, the air bags and the antilock brakes. Mechanics now diagnose problems by connecting a handheld computer to the vehicle. The computer gives the mechanic a code of numbers or letters that designate the source of a problem. Without the reference material to interpret the code, a mechanic can't fix the car.

"We just say, 'We're sorry. You've got one option -- go to the dealer,'" said Pride, manager of The Car Store outside Washington. All repair shops must get some emission system codes because of the Clean Air Act. Some members of Congress worry that higher-priced dealer repair shops are using the codes to corner the repair market. Lawmakers have introduced legislation to require manufacturers to share diagnostic codes with car owners and independent repair shops. Also, the Environmental Protection Agency is developing a plan to require that automakers publish online all the codes related to emission repairs.

Cars built since the 1996 model year must have computer-controlled emission systems to meet clean air laws. "Most

Garry Small Saab

Saab Exclusive for over 10 years!

800-920-7222

Non-inflated part prices.

Extensive Saab Inventory

800-920-SAAB

**Business hours: 8:00 AM
to 5:30 PM PST**

All major credit cards accepted



Shop Manual for Saabs

Saab 900 8 valve 1981- 88 Bentley
Saab 900 16 valve 1985-93 Bentley
Saab 9000 1986-95 Haynes



www.saabstory.com

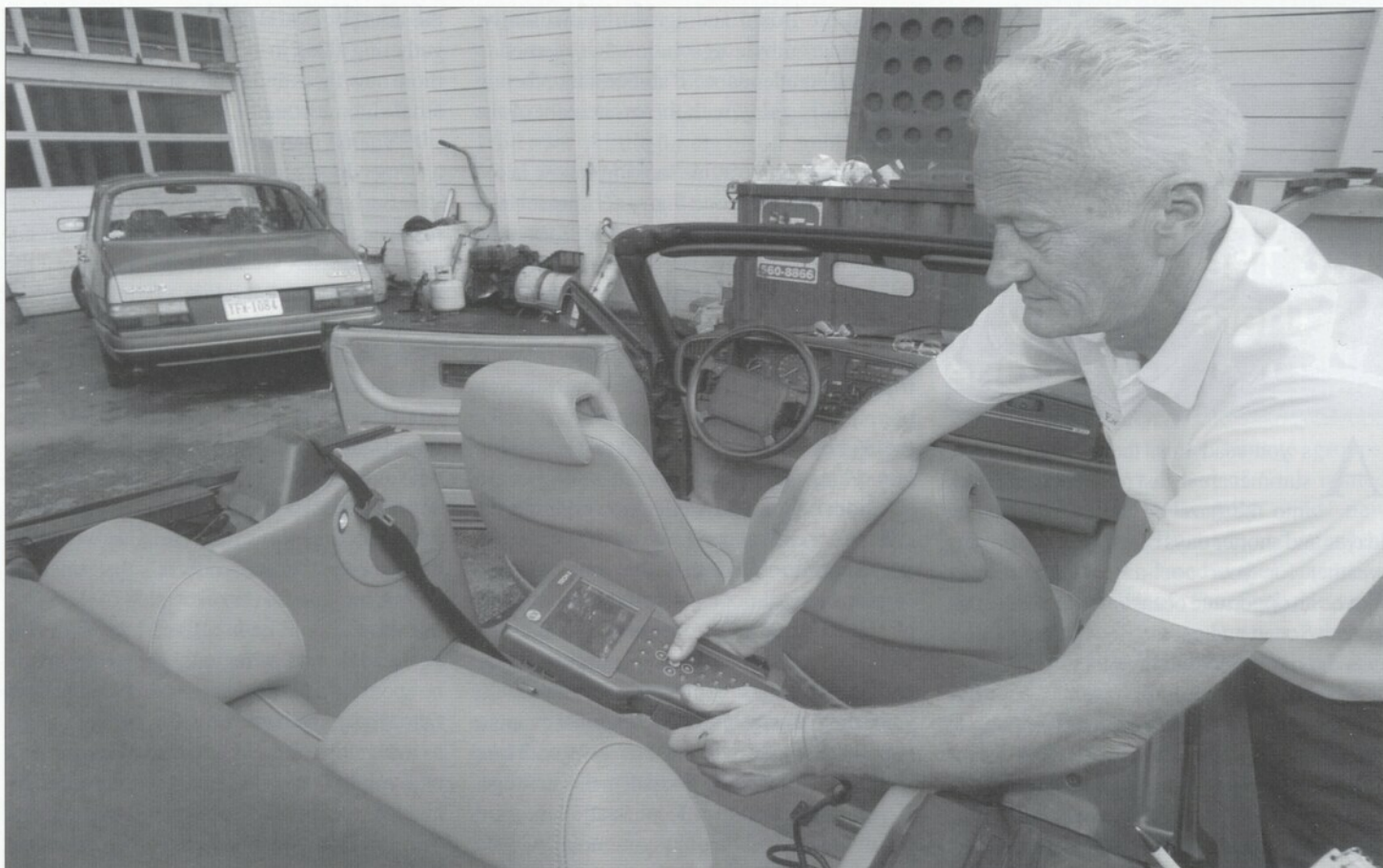

Ernie Pride, manager of The Car Store, uses a Tech-2 at his shop in Arlington, Va. (AP Photo/Rick Bowmer)

vehicles out of warranty are serviced by independent repair shops," EPA spokesman David Ryan. "And the sooner these shops catch emission problems, the better it is for the environment."

A membership survey by the Automotive Service Association, which represents 15,000 independent repair shop owners, found that 10 percent of cars could not be repaired because codes are not available. The number is expected to grow as newer cars replace pre-1996 models.

The Alliance of Automobile Manufacturers says that requiring the codes' disclosure would make proprietary information available to competitors and subject to copying. The group supports the EPA's proposal, and most of its members have signed a letter of intent to make emissions diagnostic tools for 1996 and newer cars available to independent shops by January 1. "It's in our interest to make sure emissions systems are fixed quickly," alliance spokeswoman Gloria Bergquist said. Automobile dealers made a record \$80

billion on service and parts in 2001, an 8.5 percent increase over 2000. Dealer labor rates tend to run from \$10 to \$20 per hour higher than independent shops, according to AAA.

Dealers contend it is appropriate that they have access to sensitive information while independent garages do not. "Dealerships have a franchise relationship with the manufacturer, and the manufacturer can terminate that relationship," said Doug Greenhaus, director of environment, health and safety for the National Auto Dealers Association. "They are under contract to keep that information confidential, but there is no relationship like that with the vehicle manufacturer and the aftermarket."

The emissions repair codes are linked to anti-theft devices, which is causing the insurance industry to oppose the EPA proposal. Getting the codes to more repair shops could make it easier for auto thieves to obtain that information, insurers say. "If you are a thief, the first thing you want to do

is to get a one-week apprenticeship at Joe's Garage," said Kim Hazelbaker of the industry-funded Highway Loss Data Institute.

Aaron Lowe, vice president of government affairs for the Automotive Aftermarket Industry Association, says a potential thief also could find work at a dealership. "We don't think their problems are real, and we think they all can be resolved," Lowe said. "It will be a lot better for repair shops and technicians to more efficiently repair cars, and that will ultimately benefit the consumer." EPA officials say they hope to resolve the insurance industry's misgivings about the proposal.

Copyright © 2002 The Associated Press. All rights reserved. This material may not be published, broadcast, rewritten, or redistributed. Used by permission.

Ramblings and Demands



by
Phil
Lacefield
Jr.

And Then, There Actually Was One

As you read this, the steamy days of summer are in fast retreat, chased back into the haze by the ever-reddening leaves and shorter days of fall. Perfect driving weather for your cool-air-loving turbo, or maybe an opportune occasion to break out that project Sonett and get the floor fixed before it gets too darned cold to do either.

Too bad we couldn't have had days like this in August. If you were lucky enough to have made the pilgrimage to Cincinnati for the SOC02, you know exactly what I mean. For four days in southwest Ohio, it was *hot* – in the melt-your-shoes, melanoma-inducing, leather seat-frying sense that made the Sonora desert seem downright chilly in comparison. Many suggested we find a cooler place for the SOC – say, Morocco, or perhaps the cool breezes of Death Valley. Make no mistake about it, the air was steamy – we broke three all-time heat records on that weekend – but the fellowship was phenomenal and the buzz about town was that this was one of the best SOC's in recorded history.

All of which warms my heart to the brim with fuzzy warm feelings of joy, but nothing can compare to the feeling I got watching the birth of the new Saab Club of North America on Sunday morning. After much fire-siding and back-room dealings during the SOC (including the hilarious and now highly collectible "anti-BMW" buttons that were in circulation) those in attendance who had become full-voting SCNA members put their hands in the air and elected us an honest-to-goodness Executive Board. I cried like a baby; it was truly a sight I'll remember for the rest of my days. The ultimate culmination of the work I and several other concerned citizens have been putting forth for the past year and a half, to get a national club scene up and running. Well would you look at that – in less than the three hours allotted to us, we had

elected the Board and agreed, miraculously, on an interim bylaws solution that seemed to make all in attendance if not ecstatic, then at least mildly giddy with the excitement of the whole thing.

You'll notice a fine looking fellow in the front of this issue, one Garry Grimes. He is your new President, and not a finer man among us could have been chosen. It is with great honor that I find myself working for and with the Board to make the SCNA a club of which Saab aficionados the world over can be truly proud. We will work hard at the direction of you, the voting membership body, to make the SCNA what YOU want it to be, nothing less. Please, let us know what it is you want in a national club, and we'll do everything we can to make it happen for you.

Keep in mind that the national club cannot and will not exist without the support of the existing and upcoming regional and local clubs; indeed, the base purpose of the SCNA is to funnel members back to the locals, since there's only one or two national events a year at best, and without that give and take neither will prosper or flourish in this new age. If you aren't part of a local Saab club, join! Don't have a local club in your area? Create one! The SCNA will be happy to show you some fantastic examples of how to do it right, and you most likely won't have to look very far as there are many outstanding regional clubs out there right under your nose. Having trouble with membership retention or interest in your local club? Let the SCNA help by shunting our new members into your ranks!

This whole task has just gotten a bit easier, in fact, with the continuing help from our good friends at Saab Cars USA. In the next couple of months, a spiffy new insert will begin appearing in the "Welcome to SAAB" box of goodies that gets shipped out to every new car buyer and leaser in the country. If you haven't seen one of these things, it's a neat gray box filled with the "Made In Trollhattan" mini-coffee-table book (containing quite a few pictures of some of our membership!) as well as financing offers, updates and a nice form letter from Dan Chasins. Bring home a new Saab and one of these beauties can be yours. If the sales numbers are to be believed, upwards of 40,000 new Saab nuts will be receiving this packet at their homes soon after taking possession of a new Saab – and if only ten percent of those interested sign up, our membership ranks could well *double* in one year. With the introduction of the New 9³ and

the amazing wave of good press it has been gathering along in its wake, expect to see even more new faces and happy smiles at your next local club meeting.

Thanks again to all who made the SOC02 a tremendous success – especially my lovely wife Sasha, whom I kept forgetting to thank in my speeches at the convention. Without her support the SOC02 would not have been the millennial party that it was. Thanks, sweetie, and please do try to remember where you hid all my precious Strawberry Quik.

Folks, I just don't know if I can put into words how magnificent the SOC02 was, both for myself, for those in attendance (well, those who didn't fall over from heat stroke, anyway) and for all the sponsors and volunteers without whose help the show most certainly would not have gone on. There is now talk that, since the SCNA has taken over ownership of the SOC, the show should be in a fixed location every year and that a few regional gatherings might be sponsored for the fringes of the country too far to make the haul; we'll have more on that as it develops. Rest assured, anything the new club might decide to pursue will appear here and on the Internet at www.saabclub.com. Stay tuned; if you miss a minute you'll miss a lot!

800-270-SAAB

Parts and Service

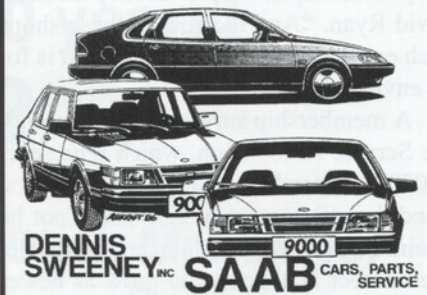

334 Wilpen Road
Ligonier, PA 15658

View our current car list at
www.dennissweeneysaab.com

New and used parts, sales
of Road Tested Saab Cars

Service in Greater Pittsburgh
area and points east



5 Minutes Up Late (sic)

I tore up my column I had started prior to the convention, and now I wish I hadn't! I've got a lot of disorganized anecdotes swimming around in my brain and I can't make them coherent! But here goes, anyway!

I hope those of you who attended the 2002 Owners Convention in Cincinnati enjoyed it as much as I did. The camaraderie of the conventions, is unmatched in the car enthusiast realm as far as I know. The number of 2-stroke cars, especially bullnose, in attendance at Kings Island was very encouraging! While many parts are hard to come by, the amount of determination factored by what a select few of you are willing to put into your project cars is unmatched per just a few years ago.

I'm still recovering, physically and mentally from the time "off": 2 days of 12 hours driving each way with truck and trailer, two sweltering LONG days out in the heat with your good souls, and Sunday,

which was all the time I had to 'chill out' and enjoy the passage of time without countless demands on mine! I drove two 2-stroke Sonetts, worked on one of them, plus I did a lot of little tuning on other 2-strokes, V4s, 99s and even a 900 for convention attendees. Our little parts tent grossed around \$3500, which after cost of goods sold and our discounts at the show still covered our costs and a bit more. Thanks to those of you who came over and saw Kyndra and/or me, whether you bought something or not!

The best feature of this year's convention was the increased participation of you, the SAAB family, in planning and running the convention. For those of you in attendance this year who are new to the fold, I hope you saw the level of community and cooperation inherent in these gatherings. With Garry Grimes & Co. at the helm of your new national clubs organization, your continued involvement, support and active participation are very important. Yesterday and today I have been reading back through my past newsletters collection going back almost 25 years, deep into the days of Messrs. Grossman, Delahorne and Winker,

whose popularity came not from a tenable organization of people but by a communications medium of a newsletter. While NINES magazine continues to flourish and publish great articles by talents far outstripping my meager abilities, it does not constitute a club, an organization of people, ideas, and their cars; it does not have the ongoing conversation which was so pivotal to the early newsletters on which "THE SAAB CLUB" newsletter was named. The communications medium which TSC and NINES provided has been replaced by the Internet forums such as The Saab Network, Turbo! and the various vintage groups, wherein a different brand of Saab related fervor is kicked up daily, and new friendships continually made and strengthened. The support offered at the convention by Scott Patterson of The Saab Network (<http://www.Saabnet.com/>) is one wherein perhaps the new SCNA should consider formally embracing to the same degree as this magazine, as an official mouthpiece of the Club. TSN has done great things for the regional clubs in the past, through increased communication between Saab owners nationwide and worldwide; and now with the advent of the national "umbrella", the regional clubs have only to benefit from such an arrangement.

One last thing. To those of you in regional Saab clubs yet reluctant to affiliate with the new National Organization, I cannot say more strongly: you cannot help but benefit from a National Club. It ties and binds your club with every other club in the USA and Canada and allows the entire continent the benefit of learning from and participating in your activities. Why would you want to shut out members of your Saab family? There are still many regions of North America not yet represented by a Saab Club (greetings from southeastern Virginia!), and perhaps this will change if enough national club members can learn by your examples. The Central Penn and Minnesota/Iowa clubs are two fine cases in point. Use the resources you have at hand to make a change for the better. Your Saab brothers and sisters out here thank you for it!

The inset photo of Chip Lamb is a clip from a photo taken by Martin Hilvers at the 1999 SOC. The full photograph is pic #5 at <http://members.tripod.com/mhilvers/keystone/key.htm>

WEST of SWEDEN SAAB

specializing in the two digit Swede

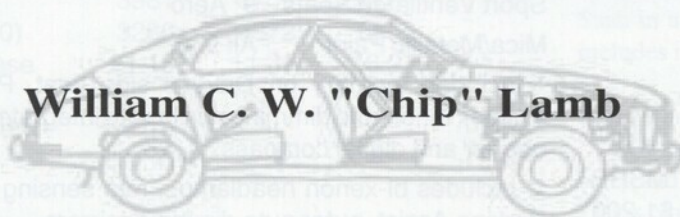

William C. W. "Chip" Lamb

Supporting Models 93 Through 99
New, New-Old-Stock, and Good-Used Parts
Restoration and Vehicle Inspection Services
Friendly Helpful Advice

Call Us Today!

tel: (804)829-9040

e-mail: chip@wmsbrg.com

web: <http://www.wmsbrg.com/sweden/>

2003 Saab Pricing

Saab has announced its 2003 model year pricing. Contrary to what may have been printed in NINES editorials, the prices on 2003 9⁵ models are the same as for 2002, despite the inclusion of ESP as standard equipment on the 9⁵ Linear and the integration of a compass reading and garage door opener into the Arc and Aero's standard autodimming rear mirror. The 9⁵ Linear "Premium Package" price is lower, reflecting the inclusion of ESP into the Linear's Standard equipment, while the "Touring Package" price is increased due to the external automatically dimming exterior mirrors. For 2003, USA 9⁵ Aero purchasers will qualify to participate in the Aero Flight Academy, a weekend of on-track performance driving instruction patterned after the well received Viggen Flight Academy.

The 2003 9³SE convertible is essentially unchanged from 2002. An available "Sport Package" includes virtually all of the Viggen Convertible's styling and chassis features, save the 230 hp. 2.3 liter engine. Pricing for the New 9³ Sports Sedan is very competitive, ranging from \$25,900 for the Linear sedan with standard equipment to \$37,050 for Vector sedan equipped with every possible option. A sunroof is optional across the 9³ Sport Sedan model line, a real benefit for tall people who find a couple of extra inches of headroom to be far more useful than a view of the sky. Headlight washers are bundled with heated front seats.

New colors for 2003 include Merlot, a medium-dark metallic red, and Dolphin, a non metallic medium grey. Graphite Green, a dark metallic green, replaces Sun Green, a bright metallic green. Nonmetallic colors black, Polar White, and Laser Red, and metallic colors Cosmic Blue, silver, Hazelnut, Steel Grey, and Midnight Blue are continued.

9 ³ Models	Model Code	MSRP
9 ³ SE Convertible	352	\$39,995
9 ³ Linear Sport Sedan	304	\$25,900
9 ³ Arc Sport Sedan	344	\$29,995
9 ³ Vector Sport Sedan	354	\$32,495

9 ³ Options	Model Availability	MSRP
Automatic Trans	9 ³ SE Convertible	\$1,200
Design Package ¹	9 ³ SE Convertible	\$795
Sport Package ²	9 ³ SE Convertible	\$1,995
Front Heated Seats	9 ³ SE Convertible	\$475
TOP2 (Blue top)	9 ³ SE Convertible	\$500
Sentronic A/T	9 ³ Sport Sedan (Linear/Arc)	\$1,200
Sentronic A/T with steering column controls	9 ³ Sport Sedan (Vector)	\$1,300
Power Sunroof	9 ³ Sport Sedan	\$1,100
Linear Touring Pkg ³	9 ³ Sport Sedan (Linear)	\$995
Arc/Vector Tour Pkg ⁴	9 ³ Sport Sedan (Arc/Vector)	\$1,195
Linear Launch Pkg ⁵	9 ³ Sport Sedan (Linear)	\$2,595
Sport Wheel Package ⁶	9 ³ Sport Sedan	\$1,295

Front Heated Seats ⁷	9 ³ Sport Sedan	\$495
Mica/Metallic Paint	All 9 ³ s	\$475

- ¹ Black leather with red inserts, carbon-fiber IP, matte-chrome door handles
- ² 17" Double-three spoke wheels, Sport Steering wheel, rear spoiler, Aero body kit, Sport leather seats, Carbon-fiber IP
- ³ Automatic Climate Control, Bi-xenon headlamps, auto dimming mirror, integrated garage door opener with compass
- ⁴ Rain sensing wipers, Saab Parking Assist, bi-xenon headlamp, in-dash 6-disc CD changer
- ⁵ Infotainment audio, in-dash 6-disc CD changer, color exterior matched trim, power sunroof, 16" 10-spoke alloy wheels, power driver's seat
- ⁶ 17" 5-spoke alloy wheels, tire pressure monitors, sport tuned chassis
- ⁷ Includes headlamp washers

9 ⁵ Models	Model Code	MSRP
9 ⁵ Linear 2.3t Sedan	524	\$33,995
9 ⁵ Linear 2.3t SportWagon	525	\$34,695
9 ⁵ Arc 3.0t Sedan	574	\$38,650
9 ⁵ Arc 3.0t SportWagon	575	\$39,350
9 ⁵ Aero Sedan	584	\$38,650
9 ⁵ Aero SportWagon	585	\$39,350

9 ⁵ Options	Model Availability	MSRP
Sentronic Auto Trans	9 ⁵ Linear and Aero Models	\$1,300
Premium Package *	9 ⁵ Linear 2.3t	\$1,495
Touring Package **	9 ⁵ Arc and Aero Models	\$1,195
Sport Ventilated Seats	9 ⁵ Aero	\$995
Mica/Metallic Paint	All 9 ⁵ s	\$475

* Includes memory on Driver's side seat, Prestige audio system, inner auto dimming mirror with integrated garage door opener and digital compass.

** Includes bi-xenon headlamps, rain sensing wipers, Saab Parking Assist, outer auto dimming mirrors

Special Charges	Models	MSRP
Transportation	All 9 ³ and 9 ⁵	\$625

Sales

Sales during the period continued to be strong, with total sales of 7737 cars, up by 16% over the relatively strong 6656 cars sold in June and July, 2001. 9⁵ sales of 4136 total eclipsed the 9³'s 3601 cars despite a very strong June for the 9³. We believe the dwindling stock of 2002 9³s combined with the continuing favorable press reports of the 2003 model and renewed marketing emphasis on the 9⁵ will motivate further weak 9³ sales until the new model becomes available. Dealers tell us that the stock of 2002 9³s is very low, suggesting that Saab's marketing strategy of "clearing the decks" of 2002 models in preparation for the New 9³ launch is operating as planned.

This period is a perfect example of what gives Saab the confidence to predict that the New 9³ Sports Sedan will be the vehicle to generate a near doubling of sales this decade to 200,000 world wide and close to 70,000 in the United States. Admittedly constrained by very low supply, total 9³ sales in the period were less than the 9⁵'s 4136 cars, even with a good seasonal result from the convertible. By comparison, the BMW "3 Series" models' sales are roughly three times that of the larger, more expensive "5 Series". Allowing for some cannibalization of 9⁵ sales by a more modern and mainstream 9³, sales volume of 12,000 cars per two month period, depending on the season, could be predicted based on current 9⁵ results.

	JUN '02	JUL '02	period
coupe 93	9	1	10
viggen coupe	7	7	14
sedan 93	26	0	26
sedan 93 se	1109	540	1649
viggen sedan	17	21	38
convertible 93	2	0	2
convertible 93 se	1086	645	1731
viggen convertible	95	36	131
total 93	2351	1250	3601
sedan 95	684	1405	2089
sedan 95se	141	198	339
Aero 95	327	425	752
wagon 95	316	345	661
wagon 95se	76	69	145
Aero Wagon	86	64	150
total 95	1630	2506	4136
IDS	18	9	27
total (2001)	3981	3756	7737
last year (2000)	3286	3372	6658
percent increase	21.15	11.39	16.21
total year to date	24314		
previous year	20118		

Certified Pre-Owned

Saab's recently announced Certified Pre-Owned program has undergone a major revision. The warranty program has been transferred from an independent aftermarket provider and is now administered through Saab's new car warranty offices. Along with the change of administration is an extension in the length of coverage to 72 months from the original in-service date or 100,000 miles (whichever comes first). For the first 4 years or 50,000 miles, whichever comes first, the new-car limited warranty is in effect, and the 6-year/unlimited mile new-car corrosion protection limited warranty is transferred to the new owner. The extended coverage does exclude certain items covered by the new car warranty, most notably brake pads and rotors, clutch discs, telematics (*OnStar*), audio equipment, and batteries, but there is no deductible for

covered repairs and Saab's Roadside Assistance program is in effect throughout the extended warranty period.

There is even a shopping list on Saab's website, www.saabusa.com, where an inventory of Certified Pre-Owned Saabs can be sorted by model, year, price, mileage, or the selling dealer's distance from a given zip code. We looked and found that about half of the 95 certified 9⁵ SportWagons on Saab's website were model year 2001 or 2002, many with under 10,000 miles and one with just 101 miles! We know first hand of a 2002 9⁵ that was traded after just 200 miles because the owner "didn't like it," which was given Certified Pre-Owned status. For those more mindful of long warranty coverage than ultimate "newness", these very low mileage cars present an interesting alternative for Saab buyers.

Press Quotes on the New 9³

William Diem in the Detroit Free Press:

The new four-door 9³ has a trunk big enough for one person to hide in. The only reminder of Saab's days as odd-car-out is an electronic ignition key shaped like a light bulb that you insert in the center console instead of the steering column.

The steering is tight, and the car holds the road well. Electronics at the wheels help you avoid terrible mistakes, but they allow you to be noisy. The antiskid Electronic Stability Program lets you squeal the tires in a corner, and sudden hard braking leaves a rubber patch on the road despite antilock brakes.

And quoting: "The Sport Sedan is mainstream," said 9³ chief designer Aamer Mahmud, "but the other variants will express more style, especially the four-wheel drive."

By John McCormick in The Detroit News

Inside, the roomier, new 9³ has a familiar, stylishly technical Saab instrument panel, supportive seats and an impressive level of fit and finish. From a driver's perspective this is clearly the first Saab in a long time to match up with the best in its class, which includes rivals such as the Audi A4 and BMW.

Loyal Ford in the Boston Globe:

On the twisting back country roads of Sweden, both the entry level and high-end models performed with confident power (the 210 is close to being a screamer) and the stiffer body structure and better, tighter suspensions were a joy.

There was no turbo lag and, remarkably, no torque steer such as that which plagues the Viggen (a car which is going away). Driving the 210 horsepower 9³ I was able to throw it into multiple corners, trying to make the rear break free (oversteer) or the nose to plow (understeer) and could not induce either.

The car sat flat through hard, tricky corners (Sweden seems to love the incredible shrinking radius turn), sat like a brick in fast-lane changes on the highway, and showed only minimal nose-dive in heavy braking.

This new car puts Saab right back where they belong - in the hunt with Volvo, Audi, BMW, Lexus, and other sporty, luxurious brands. And it also reverses what was once a troubling question: Instead of asking, as some did fearfully, what GM will do to Saab, we can now ask hopefully what Saab might do to GM."

www.andrewsofprinceton.com

Andrews Inc. of Princeton

Home of Andrews Certified, Quality Checked and Program Preowned Saabs

PHONE: (203) 284-8989
FAX: (203) 269-8842
www.luxurycars.com



IMPORTS UNLIMITED

569 N. COLONY RD.
WALLINGFORD, CT 06492

MICHAEL CARO
President



IMPORTED AND DOMESTIC
AUTOMOBILES



SAAB

The Oldest SAAB Dealer in Iowa
3rd Generation
Family Owned and Operated

Marty J. Adams
Meyer Garage, Inc.
SAAB Imports
2687 480th Street - McIntire, IA 50455
(641) 737-2239 Fax (641) 737-2601



PLANET SAAAB

COMPLETE SAAB SERVICE
CERTIFIED MASTER TECHNICIAN
FACTORY TRAINED

JAY SITTON
(415) 552-7222
(SAAB)

45 Dore Street
San Francisco, CA 94103
Between 9th & 10th, Off Howard

Dave Towell Saab

John Schoblocher
SALES PROFESSIONAL
GOLD LEVEL RECOGNITION



SAAB

111 West Market Street
Akron, OH 44303
TOWELL1@AOL.COM

Tel. 330/376-9600
Fax 330/376-8724



EUROPEAN EXCHANGE, INC.

Specializing in Transmissions for Fine Imported Automobiles

MERCEDES BENZ • BMW
SAAB • JAGUAR
PORSCHE • AUDI
PEUGEOT • VOLVO, ETC.

Rich Varjan
201-489-7770
155 Lodi St., Hackensack, NJ 07601

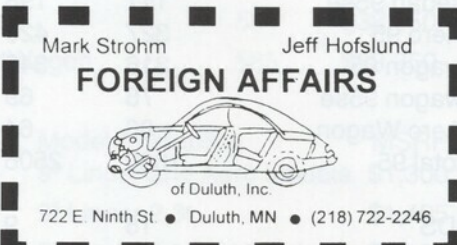

Mark Strohm Jeff Hofslund

FOREIGN AFFAIRS



of Duluth, Inc.
722 E. Ninth St • Duluth, MN • (218) 722-2246

Tim Brown Kevin Booth

INDEPENDENT SAAB SPECIALISTS



We want you and your car to be happy

Full Service Auto Repairs

http://www.saablitzauto.com (717) 626-5264

Strandberg's Auto

Volvo Specialist
Parts For European Cars - Rebuilders

John & Kevin Strandberg

P.O. Box 430 • 615 Polk • Centuria, WI 54824
800-448-5121 (Nationwide) • 715-646-2388

Overseas Speedometer

1-800-444-0292
512-329-8200
Fax 512-306-0276
www.speedometer.com

Rick Borth, Owner

Cable-Driven & Electronic Units • MB Quartz Clocks

- Audi • BMW • Porsche • Mercedes • Saab
- Volkswagen • Volvo • BMW Motorcycles

Please U.P.S. to: 100 Wallis Drive, Austin, Texas 78746

All Recycled Saab Parts

93B, 95, 96, 99, 900, 9000



East West Auto Parts, Inc
4605 Dawson Road
Tulsa, OK 74115-4102

800-447-2886
or (918) 832-7077
FAX (918) 832-7900
website: www.eastwestautoparts.com



SAAB Technician-Mobile Service

Los Angeles CA



Walter Wong

Factory Trained
(310)666-2406 saabtech@pacbell.com



SAAB ORIGINAL sales brochures

showing all Saab models, interiors, and features. Great for Restorations or Gifts! 1957-59, \$25; 1960-69, \$18; 1970-79, \$15; 1980-present, \$12. ALL PRICES PER YEAR. Add \$3.50 shipping. Specify year, model. VISA/MC. Also have literature and manuals for all cars/trucks/motorcycles, worldwide. Walter Miller, 6710 Brooklawn, Syracuse, NY 13211. 315-432-8282. Fax 315-432-8256. www.autolit.com

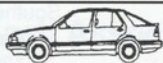

SAAB

SERVICE & REPAIR

JERRY SWEET
973-252-5151

Sweet Motors
379 U.S. Highway 46
Mine Hill, NJ 07803



New and Used SAAB parts

VISA/MASTERCARD ACCEPTED
TOLL FREE ORDER LINE

1-800-882-7220

Info: 763-631-Saab Fax#: 763-389-3875
3558 Brickton Road, Princeton, MN 55371
www.andrewsofprinceton.com
E-mail Chuck@andrewsofprinceton.com

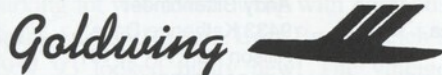

USED PARTS WAREHOUSE
1-800-SAAB-137

www.goldwingsaab.com

TEL: 315-625-7969 FAX: 315-625-4862
P.O. BOX 315, ROUTE 11, HASTINGS, NY 13076

SEE WHAT WE DO

Restore your car — better than new!

Sleeve and rebuild brakes:
master, wheel, calipers
servo, slave, clutch cylinders,
proportioning valves and
boosters, reline shoes

← Lifetime Warranty
← Quick Service



White Post Restorations

One Old Car Drive P. O. Drawer D, White Post, VA 22663
(540) 837-1140 www.whitepost.com



SAAB

- Body & Frame Repairs
- Used Part Sales
- Mechanical Services

Auto
Restoration
Techniques

James T. Meara
614-299-2381



Genuine Parts, Authorized Service, Warranty
Preowned & Program Car Sales

Taliaferro Imports, Inc.
525 North Price Lane
Springfield, MO 65802



Authorized Service
417 831-SAAB
FAX 417 831-4722



TROLLHATTAN AUTO PARTS INC.

SPECIALIZING IN PARTS FOR SAAB & VOLVO

OEM, OE & AFTERMARKET PARTS AVAILABLE
PARTS DISCOUNTS UP TO 50% OFF LIST PRICE

CALL FOR MONTHLY SPECIALS

SAAB 1800-32TROLL VOLVO

http://www.cybertroll.com 410-682-2827

MOST ORDERS SHIPPED WITHIN 24 HOURS / VISA, MASTERCARD & AMERICAN EXPRESS ACCEPTED

SAAB OWNERS BEWARE

Traffic police assume Saab owners have above-average incomes, which is why they target you for traffic tickets. They think you're more likely to pay up than to contest their revenue-generating practices in the courtroom. However, they overlook the fact that Saab owners are more educated and more motivated to stand up for their rights.

for Membership Information Now!
1-800 SPEED TRAP
or visit our Web Site at www.motorists.com



National Motorists Association

402 West 2nd Street, Waunakee, WI 53597
Phone: 1-608-849-8000, Fax: 1-608-849-8697
E-mail: nma@motorists.com

"THE BEST SAAB SURFING SITE"
for GREAT savings on parts

www.scanwestauto.com



Scanwest Autosport

Seattle's Foremost Independent Saab Repair Shop

888-90-TURBO
(908-8726)



CHECK OUT
JEFF'S
MANAGER SPECIALS

Townsend Imports

Greensboro, NC SAAB Specialists
Saab Master Technician - ASE Certified
http://www.townsendimports.com/
Host of The Saab Network Tech Chat - Sat Nights



Exclusively
SAAB
Since 1969

Rust Free Used Parts
There is NO RUST in Colorado
125 SAAB'S TO PICK FROM

1-800-757-7222

519 Lipan St - Denver, Colorado 80204-4906
Phone (303)595-4646 - FAX (303)595-0124
www.milehibodyshop.com

Paragon Performance

The Leader in High Performance
Automotive Hose, Fittings and Adapters

We Specialize in Saab Stainless
Steel Braided Brake Line Kits!
Prices Start at \$77.00 for a 4 line kit

We also offer Stainless Steel Braided Hose, Aluminum
Fittings and Adapters for Fuel, Oil & Transmission Lines

Come visit us at:

http://www.paragonperformance.com
1-800-270-0333

North American Saab Clubs and Contacts

<p>Appalachian SAAB Club Ken Edwards 296 Brethren Church Dr. Jonesboro TN 37659- 423-753-3153</p>	<p>Green Mountain SAAB Club (Ver- mont) Cathleen Pembroke RFD #5, Box 2758 Montpelier VT 05602-8812 802-476-7994 Email:sbprods@earthlink.net</p>	<p>SAAB Club of Central Ohio Dan Orzano 300 Sheldon Ave. Columbus, OH 43207 614-444-4885 dorzano@cs.com</p>	<p>Southern California SAAB Club Paul Florance 126 1/2 Main St. Seal Beach CA 90740- 562-493-6707 Email: SoCalSaabClub@msn.com</p>
<p>Bay Area SAAB Club (Northern California) Clifford Quan 4207 Skymond Dr. Belmont, CA 94002 650-225-7075 cliff@gene.com</p>	<p>Gulf Coast SAAB Club Ron Hernandez 2422 Killdeer St. New Orleans LA 70122-4316 504-283-0822 Email:rthrnandz@AOL.com</p>	<p>SAAB Club of Georgia Chris McPherson 915 Franklin Goldmine Rd. Cumming GA30040- 770-844-5961 http://www.accessatlanta.com/ community/groups/saabclub/</p>	<p>Tristate SAAB Club (OH, KY, IN) Phil Lacefield Jr. 3907 Grand Ave. Middletown OH 45044(513)423-9299 Email: phil@lacefield.com</p>
<p>Carolinas Saab Register Jason Henske 2830 16th St. NE Apt. #99 Hickory NC 28601- 704-256-9211 Email:NCSaabreg@AOL.com</p>	<p>Milwaukee SAAB Club Andy Saksa 2480 Eastwood Ln. Brookfield WI 53005- 262-785-1550</p>	<p>SAAB Club of Iowa Marty Adams, President PO Box 99 Stacyville, IA 5047 515-737-2239 email: info@myersaab.com</p>	<p>Utah SAAB Club Chris Cox P.O. Box 526105 Salt Lake City UT 84152-6105</p>
<p>Central Penn SAAB Club George Basehore 477 E. Main St. Middletown PA 17057- 717-944-2915 www.centralpennsaab.com saaber41@epix.net membership admin@centralpennsaab.com</p>	<p>Minnesota SAAB Club Dean Nelson 1420 15 Terrace NW New Brighton MN 55112 612-636-3771</p>	<p>The Saab Club de Montréal Peter McLoughlin 20 Roundtree Crescent Rigaud, Québec, Canada, J0P 1P0 Tel: (450) 451-5165 Fax: (450) 451-5305 e-mail:pm3000@istar.ca</p>	<p>The WASSAAB Club Mike Heyse 930 M St., NW, Apt. 208 Washington, DC 20001 Phone: 202-842-0428 mheyse@morganlewis.com or mheyse@starpower.net</p>
<p>Central States SAAB Club c/o Kyle J. Poppert 4015 N Street Lincoln, NE 68510 402-488-5730 saabarts@aol.com</p>	<p>New England Saab Association Daryle Powers, President PO Box 119 Keene, NH 03431 e-mail info@nesaab.org Website: www.nesaab.org</p>	<p>SAAB Club of NE Pennsylvania Ron Augelli 1723 Clearview St. Scranton PA 18508- 717-969-9863</p>	<p>Western Pennsylvania Saab Club Andy Bittenbinder 9433 Katherine Drive Allison Park PA 15101- 412-366-6165 www.westernpasaab.com</p>
<p>Delaware Valley SAAB Club Pat Bolmeyer 1311 Clifford Rd., Oak Hill Wilmington DE 19805- 302-994-2173</p>	<p>New England Sonett Club P.O. Box 4362 Manchester NH 03108- Email:sbprods@earthlink.com</p>	<p>SAAB Club of Texas Clay McNeely Rt 4 Box 54 Aa Hereford, TX 79045 806-364-6094 SCofTX@juno.com /www.oe-pages.com/AUTO/ Classic/scoftx</p>	<p>ON LINE CLUBS</p> <p>The Saab Network http://www.saabnet.com</p>
<p>Florida Panhandle SAAB Club Mike "SaabDude" Szostkiewicz 2016 Pritchard St. Panama City, FL 32405-1446 phone/fax 850-785-7372 email: SaabDude@bellsouth.net SaabDude@mail.saabnet.com</p>	<p>New Jersey Saab Owners' Club Larry West, Chairman 465 Tappan Avenue North Plainfield, NJ 07063 908-405-7640 njsoc@saabturbo.com</p>	<p>Saab Owners of Canada, Inc. John Casey, Pres. 4214 Dundas St. West Suite 106 Toronto, Ontario Canada M8X 1Y6 Bus. 416-239-2193 fax. 416-239-6228 email: ruefulsaab@hotmail.com</p>	<p>Turbo! Send an email request to turbo- request@secret-secret.com. Place the word "subscribe" in the subject line and the body of the post.</p>
<p>Gateway City Saab Club Greg Cassidy 3256 Bainbury Ct St. Louis, MO 63129 314-318-8508</p>	<p>Northwest SAAB Owners (<i>Washing- ton, Oregon, British Columbia</i>) Jon Kjaerulff 13425 Seabeck Hwy NW Seabeck WA 98380 (360) 830-3225 fms@tscnet.com</p>	<p>San Diego SAAB Owners' Group Chris Rogers 10559 Lansford Lane San Diego CA 92126 858-530-0019 email: chris@sandiegosaab.com web:www.sandiegosaab.com</p>	<p>VSAAB, The Vintage Saab Mailing List http://www.vsaab.com</p>
<p>Great Lakes SAAB Club Jim Laman 617 Beechwood Holland MI 49423- 616-335-5215 Email:lamanjim@juno.com</p>	<p>SAAB Club National Capital Area Alan Crosby 11886 Purcell Road Lovettsville, Va 20180 540-882-4008 alancrosby@aol.com</p>	<p>The Saab Club of North America, Inc. http://www.saabclub.com</p>	<p>The Saab Owners' Convention Permanent Web Site http://www.saabconvention.org</p>

New England Saab Association Saab Owners' Gathering



Undeterred by the weather, attendees at the 2002 New England Saab Owners' Gathering pose for a group photograph.

The 2002 New England Saab Owners' Gathering has come and gone now, and despite the weather, the Saab enthusiasm ran high throughout the weekend. NESA members began arriving as early as Thursday, and by Friday afternoon the parking lot was overflowing with gorgeous Saabs from old to new. Even Bruce Welch's 1957 93 looked pretty new! The vintage turnout this year was a lot stronger than last year, and included just about every 2-digit model including 93, 95 (2-stroke and V4), 96 (2-stroke and V4), Sonett II, Sonett V4, Sonett III, 99, and 99T. In addition we had a very strong turnout of the "newer" vehicles including the classic 900s with some gorgeous convertibles, SPGs, 9000s and newer up to the 2001 Viggen convertible.

A Friday evening BBQ around the hotel pool was a perfect venue to catch up with old friends and meet some new ones. Tuckerman's was free on tap, and more than a few attendees took a dip in the water. Tom Cox had hauled up a V4 engine from MD, and it stood at the front of the food line for all to marvel (or snicker) at. Being a celebration of 35 years of the V4 engine, we were happy to have such a good showing of V4-powered cars. The crowd gradually eased back out into the parking lot for discussions that went well into the late night hours.

Our Concours was wet, wet, wet, BUT, as one optimistic attendee pointed out "Hey, cars look better when they're wet!" And as Marc Fails noted, "We may have been wet, but we never stopped smiling." We had an awesome turnout of people from the Central Penn Saab Club, with many people driving 8-10 hours or more just to be a part of this weekend. Garry Grimes drove all the way from St. Louis to join us, without a doubt

winning the long distance award! Many people drove up just for the day. We had over 90 people registered, but many more simply came and enjoyed. Some, like Marlon Vaz and Kevin Pentowski started early Saturday morning to make it for the 3 hour Concours, and still managed to place in the judging Marlon for his SPG, and Kevin for his 1974 EMS. Numerous rare items were donated thanks to the generosity of our members, and subsequently auctioned or raffled off to benefit the club. Alan Scott drove up from Battleboro, VT with a load of parts, and gave 50% of the sales to the club. Thanks Alan! Vintage literature was available, including parts and service manuals going back to the 2-stroke models. In all, it was a tremendous success. The rain continued on and off, but boy, those cars certainly did look great. Overall best in show went to Bruce and Lori Turk with a 1961 96 AKA Puttyus Maximus, but now looking more and more like one of Erik Carlsson's faithful steeds. Following the Concours, more than a few brave souls took up the challenge of the Great White Mountain Saab Tour, driving some 150 miles through Pinkham Notch, Dixville Notch, Bretton Woods, and Crawford Notch.

Saturday evening started with Happy Hour and a banquet dinner in the Summit Ballroom. Afterwards, Daryle Powers thanked the organizers, and Marc Fails of Central Penn Saab Club addressed the crowd. Len Lonnegren was our first speaker, and gave a humorous account of just why Saab owners are so loyal, and frankly, so crazy! He reviewed the history of the marque in America, including the groundbreaking win at the Great American Mountain Rally in '56, and Saabs participation in the Little LeMans at Lime Rock Race Park in

Connecticut. Having served in Public Relations for Saab from 1963 to 1989, Len had more than a few good tales to share, but he was quick to point out that many of us are indeed quite loyal to Saab, and at times, a bit crazy! Chris Moberg then took the podium and gave an insightful talk on thinking "outside the box," that is, being resourceful given the constraints of maintaining and updating cars and engines that are no longer produced. The talk was complimented by a slide show and numerous show-and-tell items including a roller ball rocker arm assembly, a bottom ball seat lifter and a chromalloy pushrod.

Sunday morning revealed gray skies and more rain, so the Alpine slide was cancelled; it's sort of good to have dry brakes on those things! As the attendees gradually packed, bid farewell, and dispersed, it was clear that the weekend had been a success. Despite the weather, everyone had enjoyed the gathering, and plans were already being made for SOG '03.

Northeast Ohio Gathering

There will be gathering of Saab Club members and Saab owners on Saturday, October 12th at Dave Towell Saab in Akron, Ohio. Festivities will begin at 10:00 AM at 111 West Market Street, where the brand new 9³ Sports Sedan will be on display in Dave Towell's brand new Saab showroom. Door prizes and refreshments will be distributed, with lunch provided courtesy of Dave Towell Saab. Following lunch there will be a driving tour through the Cuyahoga National Park and surrounding countryside to view the autumnal foliage display. An optional dinner meeting is being planned for those wishing to extend the day.

All Saab owners and prospective Saab owners are invited to attend. If you've not attended Saabs at Carlisle or SAABtoberfest because it's too far, missed the Saab Owners' Convention because of schedule conflicts, or if you are a frequent attendee of Saab owner events, come and experience the enthusiasm of a gathering of the faithful. For up-to-date information, call Jon Schoblocher at the dealership, 330-376-9600 (Monday through Thursday, or Saturday), or email Stephen Goldberger at nines@neo.rr.com.

Adirondack Saab Run

The First Annual Adirondack Saab Run will be September 28th. We will be starting in the Lake George Village, heading around Lake George to Ticonderoga then turning north towards Ausable, Whiteface, and finally Lake Placid. I am also working on a place for a group dinner. If you plan on coming and would be interested in the dinner let me know. Please keep in mind that there is a charge for the Whiteface Mountain Toll Toad of \$8 per car and driver plus \$4 for each passenger. Credit cards are accepted.

I will also be announcing the formation of a New York State Owners Club. I will have the details of that soon, but if you wish to keep informed, send me your email address.

Stephen Pivonka II
<spivonka@nycap.rr.com>

SAABtoberfest

Lee Smith of the Swedish Underground is organizing SAABtoberfest 2002, scheduled for Oct 5. Alan Snelson will be helping to work on a route, which will be near the Wilkes Barre, PA area. Details are few right now, but Lee has indicated that we will once again return to a rural venue, which should be a lot of fun. For up to date information email Marc Fails at neuswede@mail.saabnet.com, or check Thor Carlson's web site, <http://home.ptd.net/~carlson/events.html> (Note: no "www" in the address. - Ed.)

Marc A. Fails

Swedish Car Day 2002 at Brookline, MA - October 20th

(NOTE: CHANGED DATE! previously the date was stated as the 12th - it's the 20th).

Swedish Car Day returns to the Museum of Transportation in Brookline, MA. Charles River Saab will be co-sponsoring this event for the 3rd year in a row. The weather will be uncertain, as usual. What's guaranteed is that there is going to be a slew of Saabs there, and more awards, door prizes, demos, etc. Stay tuned to the NESAs Calendar of events for details or see the Museum's website at www.mot.org/Events/calendar.html.

NESA Officers Meeting Schedule

Just a reminder, NESA officers meet the first Thursday of every month, 7pm, at the Bertucci's on Amherst Street in Nashua, NH. All are welcome to join!

We are looking for other NESA members to host Weekend Wrencher parties. Contact us at: info@nesaab.org to get on the schedule.

5th Annual Tech Session at Saab Training Center, CT - November 3rd

John Moss will take us through yet another in what's become an annual tradition at the Saab Technical Training Center in Wallingford, CT. Larry West of the NJSOC gets a lot of credit for arranging these incredibly helpful sessions. For questions regarding this event, please contact Larry at viggen@saabturbo.com.

ROBERTI

M O T O R C A R S

Specializing in
previously owned **SAABs**

UNITED STATES' LARGEST DEALER IN USED SAABS
Always over 100 pre-owned Saabs from \$3,500 to \$25,000
Home of the 100% Warranty



SAAB AUTHORIZED WARRANTY CENTER

EXPERT SAAB SERVICE

SAAB Parts (New & Used)

845-339-SAAB
www.roberti.com

385 Foxhall Avenue,
Kingston, NY 12401

On the road – Part 2

To date, you have seen articles addressing Driving or Car Control: Safe and Fit to Drive, and Are You Seated Comfortably? This time we are back on the road.

It's a big and very dangerous world out there. All vehicles are faster than they were. When I grew up, 80 horsepower was a lot of power, but now SUV's are appearing to get bigger and ever more powerful, with their drivers seemingly intent on intimidation. Mixed with cell phone usage and liberal amounts of machismo, they have convinced themselves of their own immortality. The fact is they usually are not good multi-taskers and certainly are generally extremely poor when it comes to using turn signals. So what are we dealing with while driving to work or out over a weekend with your new or lovingly restored car?

Some statistics to consider:

- Driver error accounts for greater than 90% of all road traffic accidents
- Corporate drivers have a significantly higher risk of being involved in accidents – they drive more miles
- 38% of deaths among those aged 16–19 years occurred in car crashes
- At almost all ages, males have higher vehicle death rates than females
- Passenger deaths represented 77% of motor vehicle deaths in 1999
- Sport Utility Vehicles (SUV) have a higher center of gravity and the possibility of a higher rollover rate
- Middle aged drivers develop bad driving habits and may not realize it.
- They do however, have the experience to reduce their risk through training.
- Older drivers are more likely to get traffic citations for failing to yield, turning improperly, and running stop signs and red lights

Source Documents:

Insurance Institute for Highway Safety et al
– December 2000

US Department of Transportation – Various

There are two statistics that always register with me. They are the percentage of passengers that are killed and that greater than 90% of all accidents are driver error. Staggering and very sobering statistics.

As you know from Driving or Car Control I am a believer in feet per second rather than miles per hour [mph]. I believe feet per second conveys more about the energy you are carrying, and the time it will take to dissipate that energy. It is absolutely true that it is always easier to gain energy, than it is to lose it

Put another way, at 70 mph, and with ABS capable of 0.9g of deceleration, with an alert driver, anything within one football field length of the front of your car is going to be hit. If you observe traffic on freeway off ramps, they are always far too close. The only thing that saves them plowing into each other, is that they all have the same ‘thinking’ distance. In terms of thinking, if one was even slightly faster than the other there would be an accident. Have you seen more 3 or 4 car accidents on off ramps than you have 1 or 2 car incidents?

In the same article, there was a quiz on speed differentials:

If two cars, one traveling at 70 mph, the other at 90 mph are parallel, and brake with the same efficiency at the same time, what speed will the 90 mph car be doing, when the 70 mph car is stopped? The answer was 57 mph.

This is the “squared” rule in action. As you increase your speed you increase the vehicle's energy by the increase in speed squared, and the braking (not thinking) distance is proportional to the vehicle's energy. The figures here do not exactly follow the squared rule because “thinking” distance does not square with speed.

To make another comparison, take the same two cars doing 30 mph and 40 mph and braking per the criteria above. What speed will the 40-mph car be traveling, when the 30-mph car has stopped? The answer is 26 mph. Put this into the context of driving down a street in your home town – it's “only” 10 mph faster, but think of the consequences when you come to stop. To reiterate, speed does not kill, inappropriate use of speed kills.

Feed this type of information into your now daily use of the running commentary addressed in my third article. It will remind and heighten your consideration of speed and energy. How are you doing on this new “tool”? With practice you will be a better, smoother and safer driver.

So we have faster, more powerful and some heavier vehicles on the more densely populated roads. But you can say we have ABS, and yes, that is good. It allows you to turn and brake without skidding. By the way, have you all engaged your ABS so that you will not be distracted by the steering wheel feel and the braking sounds when you do need to use it? If not, please do engage this system, but check the mirror, try it on a nice dry road with a good surface, and before you do it check your mirror again.

If the ABS system failed would you know what to do? Those living in more northerly climates certainly know about the old fashioned ABS – cadence braking. Please practice it when you can, so that when it is needed, you will remember how to do it.

Another braking method I frequently use is threshold, or some call it tapered braking. With positive pressure on the brake, think of it as wiggling your toes individually while braking, and using that toe action to progressively and firmly increase the pedal pressure. The objective is to brake as hard as you have to without locking up the wheels – it is very effective under all conditions.

I know we have all the safety systems, but I also believe that these can lull us into a false sense of security. Practice the “old” way just in case it is needed. Safe controlled driving to you all. Talk yourself into talking, and you will be safer.

This is the fourth in a series of articles that deal with defensive driving techniques.

Contributed by Gordon Booth, Team Corvette member and Chief Instructor of Drivetrain Inc. based in San Jose California. Visit www.drivetrainusa.com



As a last salute to summer, I've collected a few items pertaining to the Classic Convertibles, mostly prompted by my installing

a 1992 trunk liner on the forward wall of the trunk to expand my trunk space. This piece covers the 'bag' that protects the lowered convertible top. Next time, I'll return to our regular programming with a tally of the 99 & 900 CIS & LH hot- and cold-start kits.

unless you crouched down quite a bit. Placing the hard plastic top kit in the trunk took up all the room under the lowered top. Switching to the very latest style gains you 0.8 cubic feet! Up to 10.7 vs. 9.9. Not much, but every little bit helps with these Saabs!

Since the top stack didn't change at all through the model run, there is no problem with the smaller panel.

There were several different trim panels:

- > 98 81 764 - Up to Chassis H7002291 (1986 to early 1987 prod.) No built-in trunk light, takes up most space (9.9 cu. ft. trunk space)
- > 98 24 954 - Ch. H7002292 to ch. J7005071 (early 87 to early 88) Trunk light built into panel (early one was behind spare tire), offset to right side of car (not centered 9.9 cu. ft.)
- > 96 45 367 - Ch. J7005072 through 1990 Modified to suit altered rear structure, which was brought on by installing rear seat three-point belts. (9.9 cu. ft.)
- > 41 70 130 - 1991 through end of production. Trunk light in center of panel. Slimmest. (10.7 cu. ft)

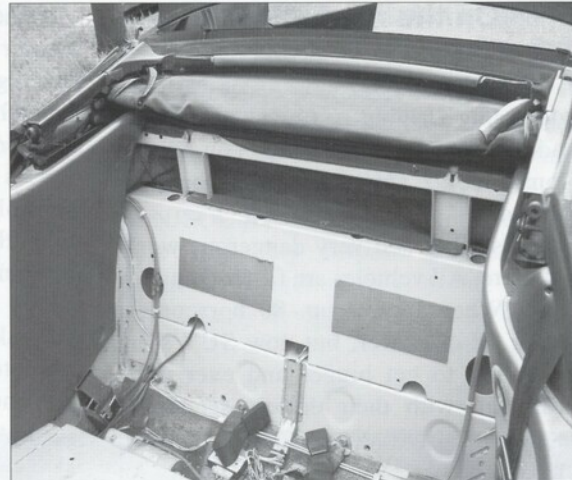

The panel rests on the torsion box reinforcement between the rear wheels.

which I found on a tag attached to the panel), merely cutting a couple slits in the material was all I needed to do. You may



Here is the early trunk space. Hard to see up front.

I finally put the parts in that I've had for close to a year, to improve the trunk space in my 1986 900t CV. The main item that gives you problems is the trim panel under the vinyl well that the lowered top (hood for you Brits) sits in. The early trim panel took up a lot of room. It was hard to see the forward most wall of the trunk,

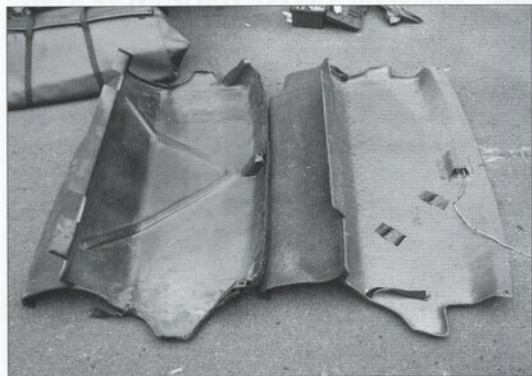

Difference: You can see the difference in the depth of the panels here.

Up through 1989, the trunk trim panels were held in place with screws, making them easy to change out. Later ones were held in with pop rivets, making them harder to deal with, especially at a junkyard. But if your car uses screws, it's fine, so long as you use large washers. There are three screws (or rivets) along the forward edge of the trunk opening. Then, there are 3 to 4 on the top of the torsion box that connects the rear wheel wells together. You'll need to remove the rear seat to get at that edge. Using the later panels (96 45 367 & 41 70 130) means you'll have to trim the lip of the panel where it goes on top of the torsion box. The structure is different. In my case (with 41 70 130,

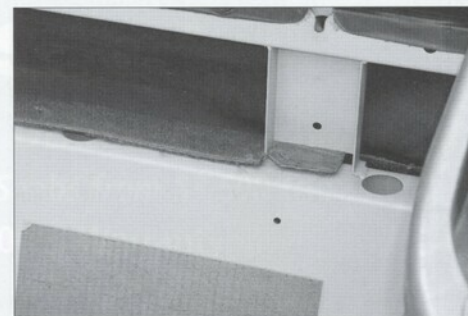

The 'new' panel had to be trimmed to fit the 'old' chassis

have to cut new holes in the material, to line up with the screw or rivet holes on your particular car.

I hate to see a wrecked convertible (for many reasons...), but if there's a part that will help improve the older cars, go get it!



More space is obvious, even in this photo.

I have taken to a regimen for dealing with the hard boot cover that works well for me and keeps the trunk available for carrying duties. Instead of keeping the hard cover in the trunk, I keep it on the back seat. I don't normally have rear seat passengers, so it's not an issue for me. The main advantage is that it simplifies the installation and stowing of the plastic parts.

Here's the way it goes when lowering the top:

The bag, with the plastic boot cover, is already in the back seat (with a blanket between the bag & the seats, to keep the seat belt buckles from marring the panel & bag), with the short flap seam on top, and the loop handles pointing to the rear of the car. Lower the top and all windows. Walk from the driver seat around the back, tucking the headliner and top behind the rear seatback to the passenger side.

Open the bag with the parts, and the passenger side panel is right there on top. Put the forward end around the seatbelt tower with the rear end angled towards the center of the car. Rotate the panel so the back edge comes under the metal trim strip at the trunk. Walk to the driver's side of the car & repeat with the other side panel. Remove the center panel and install, making sure to put the rubber loops over the nubs, and getting the rear edge under the trim panel. Snap it down. If the trunk isn't open, open it and let the safety straps fall over the trunk weatherstrip. Fold up the bag & place it in the trunk! Easy!

It's basically the opposite to remove the panels:

Place the opened bag on the back seat, with the flap with the instruction label over the front edge of the seat, with the label towards the passenger seat, the sleeves on top. Remove the center panel, slipping it into the sleeve in the bag from the back of the car. Remove the driver side panel, slipping it into it's sleeve, upside down. Go to the passenger side, remove that panel & place it on the top of the stack. **Note:** This panel rests on *top* of the ribs of the center panel, *not* inside the center panel (easier to see than describe). Pull the side flaps tight around the panels, pull the long flap over the top and close it with the short flap (resting against the rear seat back). Done!

The Concours d'Saab at the 2002 Saab Owners' Convention had three magnificent examples of Saab's Special convertibles.

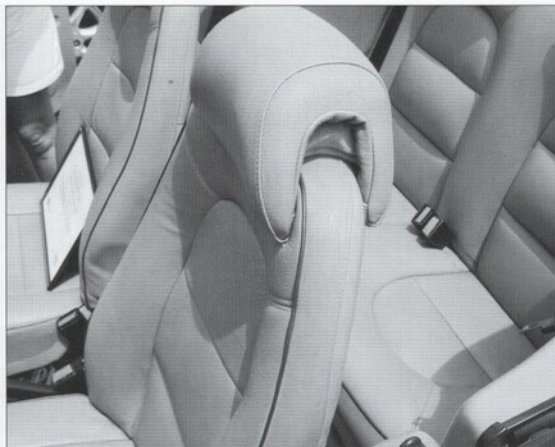

Dark brown piping adds distinction to the tan seats of the Comemorative Convertible.

Third place was won by Randall Thatcher's 1994 Comemorative Edition. "CE" convertibles are always gorgeous with their metallic black paint and brown piping on the tan leather seats. Second place was won by Kenneth Steele's Comemorative, but a 1993 model! It has all the proper bits, but is

- > Black paint & black top
- > Buffalo Grey Leather seats and interior
- > Aerodynamic side panels (like the SPG)
- > Three-spoke wheels (also like the SPG)
- > Badge delete (Like the SPG)
- > 'Springtime in Sweden' label on the glovebox door.
- > 160 HP motor (*not* like the SPG)
- > Standard springs & shocks (also *not* like the SPG)

I might be wrong (I was way too busy!), but I think this was the first convention I did not see any 1991

Special Edition convertibles in either color. But there were two 1986 Convertibles, mine, and one other. It is gratifying to see the Special convertibles being maintained and shown at Saab events. Keep up the good work!



Only one convertible got the black/grey combo - the Springtime in Sweden.

badged a 1993. It was even made *after* the 1994 above! It seems that it was ordered in Europe, which may explain the discrepancy. All 1994 900 Convertibles had to be made early because of an impending rule in the USA mandating two front airbags.

First place was won by Robert Karl Kingery's 1988 'Springtime in Sweden' special convertible. "Springtime in Sweden" was a dealer event where US dealers got their first look at the new 9000 CD. Most dealers took home a very special 1988 Convertible. The specs on this car were:



Closeup of the Springtime in Sweden emblem.

Please send e-mail to Classic.corner@saabclub.com or "snail mail" to NINES' editorial office if you have suggestions or requests!



The winning car!

Cell Phones & Road Safety: Saabs Are Leading the Way Necessity Spurs Invention

Several industry groups and government agencies including the National Highway Traffic and Safety Administration (NHTSA) have been actively publicizing the safety hazards of using hand-held phones when driving. "Vehicles have become a full-service home-away-from-home, an office, a parlor, a discussion area, a place for kids watching VCRs and so forth," said Dr. Jeffrey Runge, NHTSA Administrator. "The lack of focus on the driver's task is a major deal." These calls to discourage the use of hand held phones by drivers are having an effect.

According to National Association of Governor's Highway Safety Representatives' (NAGHSR) January 2002 study, eight states have instituted laws requiring hands-free cell phone devices while operating a vehicle. New York has a statewide ban on hand-held phones carrying a first time fine of \$100.00. Florida and California carry stiffer fines (up to \$250.00)

but the laws are currently in affect only in certain cities. These restrictions are just the tip of the iceberg. Nineteen other states are analyzing crash data related to cell phones. For those of you who attended the annual Saab Owners' Convention in Cincinnati this August, Brooklyn County, Ohio requires hands-free. Violations carry a \$75.00 fine in that Ohio county.

As if fines weren't enough, insurance and liability concerns have driven some employers like General Motors to institute strict rules against employees driving and dialing. Although there is little doubt cell phone legislation will spread nationwide, consumers seem torn over the issue. They hear the safety message, but are unwilling to give up their cell phones. In our highly mobile and frenetic society, experts agree the "stop and pull over" suggestion is out of the question. Many believe the answer lies in advanced technology, not changing consumer behavior.

One solution already available on most vehicles is a hands-free phone. "This is great news for the telematics industry," said Thilo Koslowski, lead automotive analyst for Gartner Dataquest (San Jose, Calif.). "It

means that the technologies they are working on today, such as speech recognition and text-to-speech, will have more support in the future." Sales of factory-installed units like OnStar are skyrocketing. "Cell phone legislation is going to be a boon for telematics makers," echoed Dan Garretson, a senior analyst at Forrester Research Inc. (Cambridge, Mass.). "It will be the biggest factor yet in driving people to adopt hands-free phones."

But if hands-free units are the answer, just how quick and easy is the fix? And what will be the cost? Options like OnStar are attractive because they are built into the car, but they aren't cheap. Onstar is a \$900.00 option, which is currently built into Saab's sticker price. OnStar Personal Calling, which allows calls to anyone, not just an OnStar Representative, racks up as much as \$1.00 per minute. Plus, the OnStar Personal Calling can't be used outside the vehicle, like in a grocery store or while strolling down the street. This limitation again goes against the grain of phone-addicted consumer behavior. The fact is people want their hands-free systems and their mobile phone too! Again, it's technology to the rescue.



SAAB CONVERTIBLE TOP PARTS

Top Cylinder \$120	Motor Pump \$199
-----------------------	---------------------



Hold Down tension cables \$29.95/pr
 1987-94 Stayfast Canvas Tops
 with heated glass window \$499.00
 1987-94 Headline, black \$149.00
 1995 Stayfast Canvas Tops
 without glass \$1150.00
 1996-98 Stayfast Canvas Tops
 without glass \$1000.00

HYDRO-E-LECTRIC
 5530 Independence Ct.
 Punta Gorda, FL 33982
 Call Toll-free 800-343-4261
 Tech Help: 941-639-0437
 Fax: 941-639-0376
 America's Convertible Headquarters

**FROM TWO-STROKE TO TURBO
 WE'LL KEEP YOU "SAABIN"**

		
'01 9 ⁵ TURBO WAGON, 18K, PERFECT! \$29,999	'93 9000 CDE AUTO, 134K, \$6,900	'86 900 TURBO, 5-SPD, A RUNNER, \$2,500
'99 9 ⁵ TURBO WAGON, AUTO, 62K, \$18,300	'92 900S RAGTOP, AUTO, 61K, GORGEOUS, \$9500	'71 96 50K, DRIVES GREAT, \$4,500
'97 9000 CSE TURBO AUTO, 63K, \$13,900	'89 900 TURBO RAGTOP, AUTO, 120K, NEW TOP, \$4990	'67 96 70K, COMPLETELY GONE THRU, \$3,596
	'87 9000S 5 DR, AUTO, \$2,900	

TOM DONNEY MOTORS
FORT DODGE IOWA
1-800-626-SAAB
515-546-6184
INDEPENDENT SAAB SALES & SERVICE

TRANSMISSION SPECIALISTS - 93/96 MANUALS TO 9000 AUTOS
 HIGH PERFORMANCE TORQUE CONVERTER A AVAILABLE FOR 9000

In 1999, long-time Saab enthusiasts Sandy and Jim Uhl attended the Annual Saab Owners' Convention in Keystone, Colorado. That year, Saab began offering OnStar as an optional feature, which generated a lot of buzz on the GM-built telematics system. One concern raised by many Saab loyalists was that OnStar didn't work with their personal cell phones. This concern was also commonly heard from dealers and Saab owners on the Saab Technical Hotline and Saab Customer Assistance Center, according to the Uhl's son, James. At the time, James was a product specialist with Saab Cars USA (and currently is the owner of the only "Sensonic Clutch" Saab in North America -Ed.). People loved the concept of OnStar hands-free calling, but didn't want to give up their personal cell phones.

Sandy and Jim recognize the benefits of automobile telematics, including



UHLtronics Triad allows a Nokian cell phone to be operated hands free using the OnStar microphone and Saab audio.

the speakers, and it allows the volume to be controlled by the steering wheel mounted volume controls (if the vehicle is so equipped).

The Triad system integrates hands-free OnStar Personal Calling with mobile cell phone service. If an owner decides not to sign up for or renew OnStar Personal Calling, the Triad system will still function with a portable cell phone that is cradle-mounted to the center console while driving. This means drivers have a choice between OnStar Personal Calling or their own cell phone*. All done with their hands free and eyes focused on the road!

The Triad doesn't compromise OnStar's security features because it was engineered to always give OnStar priority in the event of an airbag deployment. The Triad does not interfere with the power supply for the OnStar system; only the audio signals within the radio system are modified during installation**. Triad continues to provide a Saab owner hands free cell phone integration if the OnStar subscription is allowed to expire.

For now, the Triad is available only on Saabs, but the Uhls are working to expand to other makes soon. For more information on the Triad, visit the Uhltronics website at www.uhltronics.com or contact

them at 505-362-1597. For more details on cell phone laws go to NAGHSR's website at www.statehighway.safety.org/html/state_info/cellphone_laws.html or NHTSA's website at www.nhtsa.dot.gov.

**For seamless operation and installation, and because no other manufacturer offers the flexibility and features, use of the Nokia 6100, 5100, 7100 or 2100 series phones and hands-free car kit is recommended.*

***It is strongly recommended that a Saab authorized dealership or a reputable cell phone installer follow the suggested installation procedures to ensure you do not interfere with your vehicle's manufacturer's warranty. The selection of the installer is very important to the success and functionality of the system.*

*James Uhl
Albuquerque, NM*

Graphics and photographs by the author.

(Full installation instructions, including wiring to allow the Triad unit to use the OnStar microphone, are now on Jim Uhl's site. -Ed.)

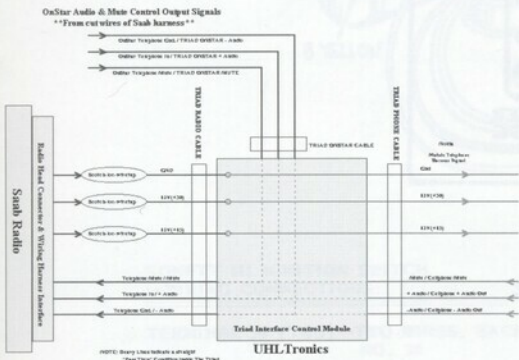

Block diagram shows how Triad interfaces with the Saab wiring.

convenience and security features like notification of airbag deployment and vehicle tracking in the event of a car jacking. While systems like OnStar solve the driver distraction problem, it has limitations and is expensive for the consumer. They designed and developed a system they call "Triad," and tested it on two Saabs over the course of two years before bringing it to market in late 2000. The Triad Interface System allows specific OnStar equipped vehicles the full convenience of a portable hands-free mobile phone. The Triad interfaces with the vehicle's audio system to allow a mobile phone conversation to be played through

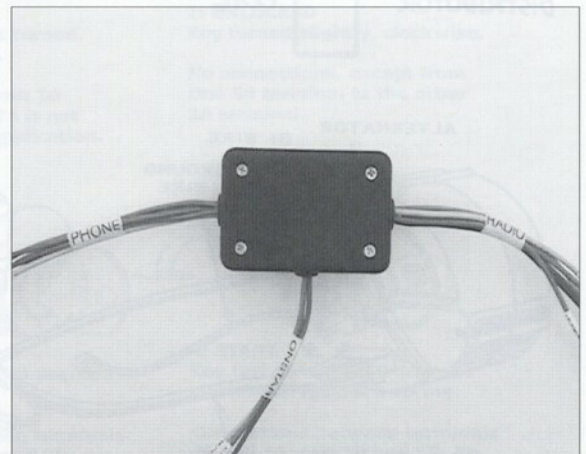

UHLtronics Triad module is inserted into the Saab wiring harness.

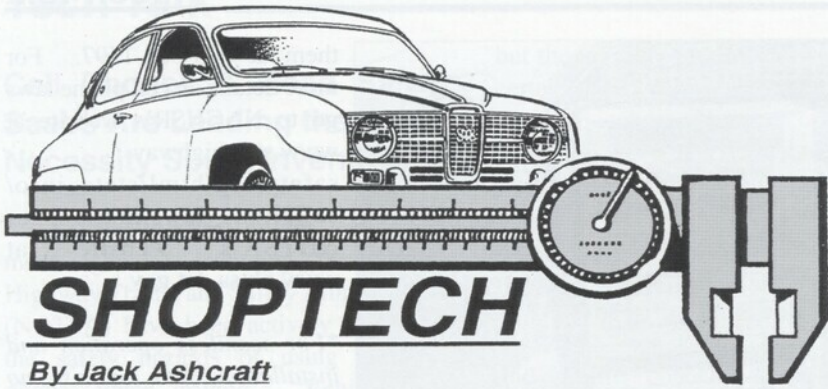

THE PRIMARY CIRCUIT 1970-74 Saab Sonett III

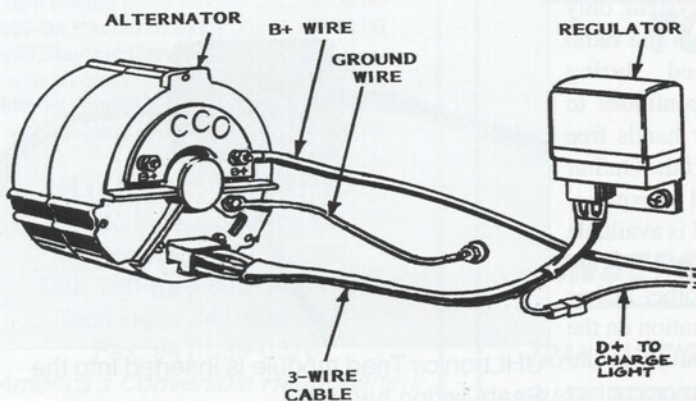
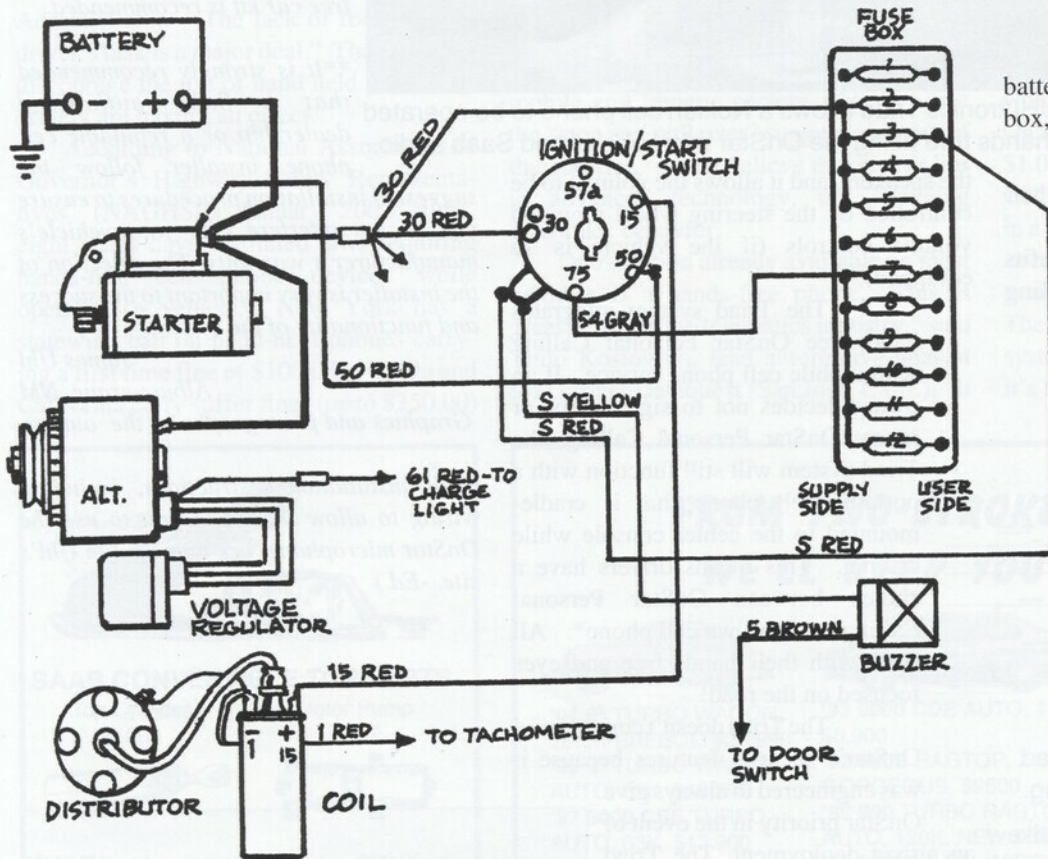

It is also helpful to study the physical wiring layout for the engine bay and some under-dash panel items. The drawing shows the physical layout as seen from the left front fender area.

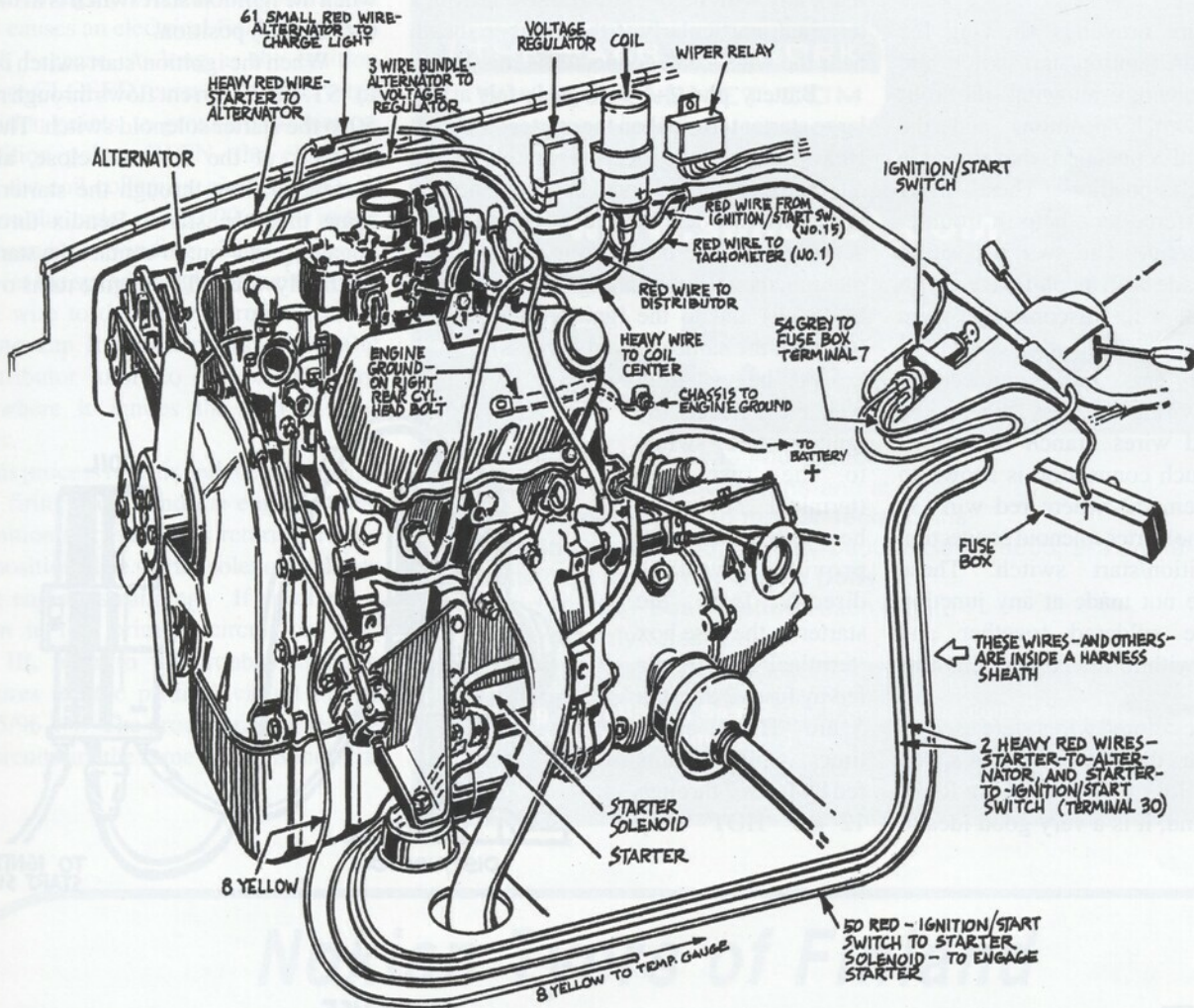

**SONETT III IGNITION SWITCH
—WIRING CONNECTIONS:**

- TERMINAL 30 (TWO)—TWO WIRES, EACH NO. 30
- TERMINAL 75—WIRE NO. 54
- TERMINAL 50—WIRE NO. 50
- TERMINAL 15—WIRE NO. 15
- TERMINAL 57a—NOT USED ON SONETT

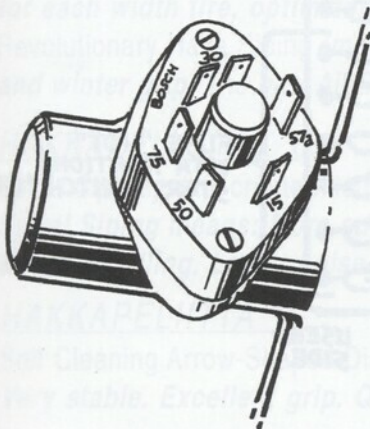

TESTING—IN EACH SWITCH POSITION:

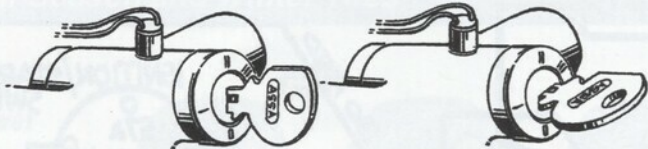

1: OFF
Key inserted but not turned.
Ignition still locked.

Connections from both 30 terminals to 57a. 57a is not used in Sonett III application.

2: UNLOCKED
Key turned slightly, clockwise.
No connections, except from One 30 terminal to the other 30 terminal.

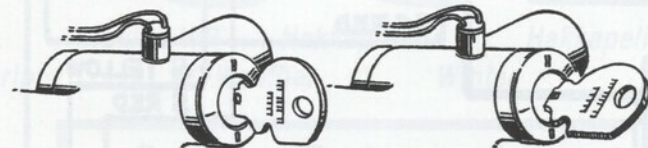

3: ON
Key turned about 120 degrees clockwise.
Connections between terminals 30 and 15, and 30 and 75.

4: START
Key turned about 60 degrees clockwise, against a spring.
Connections between terminals 30 and 15, and 30 and 50. No connection between terminals 30 and 75 in this position.

Included are drawings showing the connections to the ignition/start switch, and a series of drawings showing the four ignition/start switch positions and the internal electrical connections that are made in each switch position. These latter drawings are offered as a help in troubleshooting the circuit. The switch position tests must be made with an ohmmeter, with all the electrical wires disconnected from the ignition/start switch.

Sonett III cars have connections INSIDE the wiring harness where the number 30 red wires branch to various circuits. One such connection is shown in the wiring schematic, where red wire 30 splits between the starter solenoid connection and the ignition/start switch. These connections are not made at any junction box; they are soldered together and insulated, all within the wiring harness itself.

While more colored wires were used on the Sonett III cars than the Sonett V4's, you will note that a lot of wires used are RED. With this in mind, it is a very good idea to

mark any wire before you remove it from a terminal, particularly if the number sheath near the wire's end connector is missing.

Battery plus (+) voltage is felt at the large starter terminal on the starter solenoid. Heavy red wires connect (separately) to the alternator (via the sleeved harness that runs aft, down the left engine bay wall, then across the engine bay in front of the heater plenum, then forward along the right engine bay wall) and to the ignition/start switch (through the same sleeved harness).

A heavy gray wire 54 connects the ignition/start switch to the fuse box (terminal 7) and a heavy red wire 30 provides voltage directly from the starter to the fuse box (terminal 2). Circuits fed by fuses 2 through 5 are "HOT" at all times, while circuits fed by fuses 7 through 12 are "HOT" only

when the ignition/start switch is in the "ON" (or "RUN") position.

When the ignition/start switch is turned to "START", current flows through red wire 50 to the starter solenoid switch. The heavy contacts of the solenoid close, allowing current to flow through the starter, at the same time the starter Bendix throws the engaging gear out to contact the starter ring on the flywheel. The engine turns over.

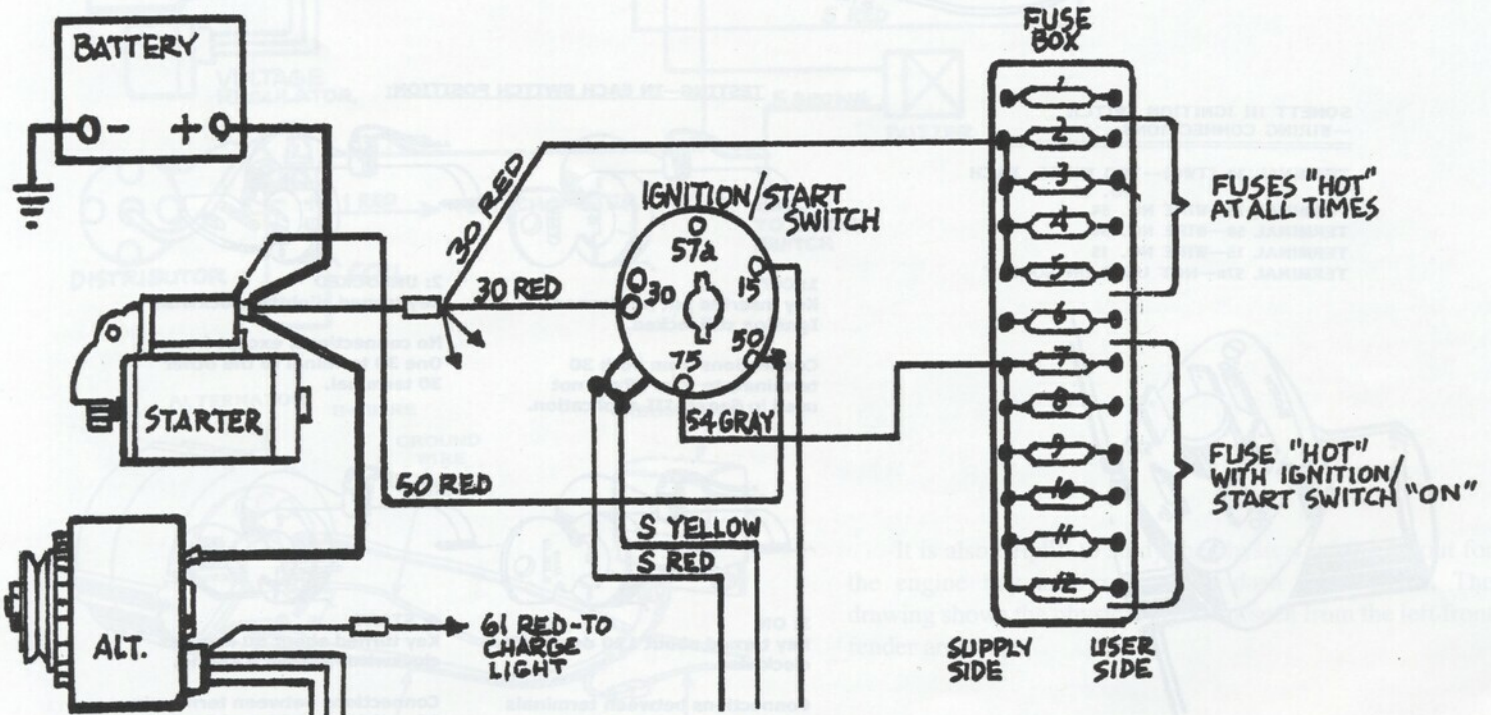
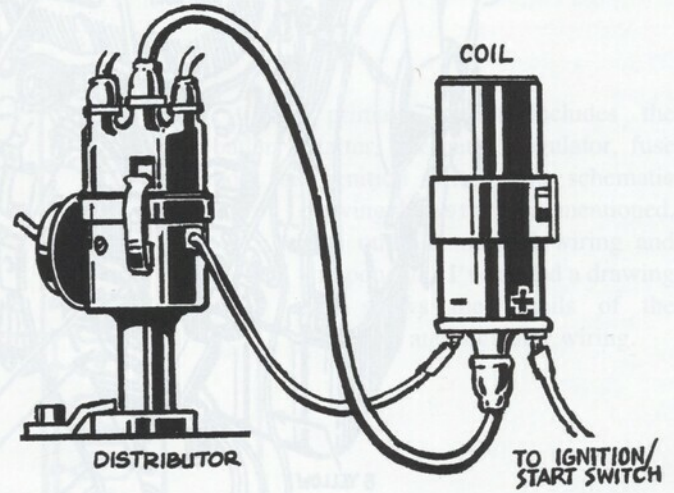

The voltage present at terminal 15 of the coil causes an electrical field to build in the coil, because, so long as the ignition points are CLOSED, current flows through the ignition points, to ground. As soon as the ignition points OPEN, the electrical field in the coil collapses, giving a voltage spike (on the order of 35,000 volts) in the coil secondary winding. This spike is carried (at the speed of light) down the high voltage wire to the center terminal of the distributor cap. It is instantly transferred (by the distributor rotor) to one of the spark plugs where it ignites the fuel in that cylinder.

This process repeats and the other plugs fire (in firing order) and the engine starts. The ignition/start switch is returned to the "ON" position. The starter solenoid relaxes and the engine is running. If you have a problem in this primary circuit on your Sonett III, refer to the trouble shooting procedures for the primary circuit of the Saab 95/96 V4. The procedures for testing these circuits are the same for the Sonett III.

THE SAAB NETWORK

WWW.SAABNET.COM

ON THE INTERNET SINCE 1988

<http://www.saabnet.com>



75,000+ pages of Saab information
Frequently asked questions and answers
Chat online with Saab master Technicians
Bulletin Boards – 99, Sonett, C900, NG900, 9000, 9-3 and 9-5
 Participate in monthly **online polls**
 Over **158,000+** Saab visitors each month
 Enter **monthly** Saab raffles

Free saabnet.com web-based email
Buying or selling a Saab? See it on saabnet.com classifieds
 Join the **saabnet.com** mailing list

saabnet.com – as featured in Consumer Reports 2001 Used Car Buying Guide

Nokian Tyers of Finland

Nokian All-Season and Hakkapeliitta Winter Tires

World's Finest All-Season and Winter Tires

NOKIAN WR ^{NEW}

New HD Silica Compound *significantly improves wet grip and increases tread life.* Tread pattern *varies slightly for each width tire, optimizing comfort and handling.* Revolutionary Haka Siping *improves driving stability and winter grip.* The best All-Season tire ever made.

HAKKAPELIITTA Q

Spiral Sipe System creates dense and stable siping. *Spiral Siping means: More snow grip. More ice grip. Better handling. Lower noise. More safe miles.*

HAKKAPELIITTA 1

Self Cleaning Arrow-Shaped Directional Pattern. *Very stable. Excellent grip. Quiet. Studdable.*



Nokian WR
All-Weather

Hakkapeliitta Q
Winter

Hakkapeliitta 1
Winter

Greer Enterprises, Inc.

Milwaukee, WI

1-800-325-2598

Summer tires, winter tires, rain tires, racing tires, all-season tires, four-season tires: tires are the most important feature in determining your car's handling properties for any surface. They are the only part of the car that touches the ground. We have always lived in parts of the country where snow and ice commonly occur over several months of the year. We have endured brutal winters when the ground was snow covered from October through March, and we have enjoyed winters so mild that we could be living in the South. We generally have equipped one car with "all season tires" which stay on all year, and one car which we change from summer tires to winter tires as the seasons change. Over the years we have used winter tires from Metzler (no longer a manufacturer of automobile tires), Kleber, Gislaved (now a division of Continental), and Nokia, which has been renamed Nokian to prevent confusion with their cell phones.

Our experience with Nokian winter tires began with NR-09 and then NR-10 snow tires. These were traditional snow tires, with deep, blocky, heavily siped treads, squared-off shoulder blocks. We purchased them in the traditionally narrow "65" aspect ratio sizes. The performance of these tires on any kind or depth of frozen precipitation was outstanding, but the driving properties on dry or wet pavement were compromised in favor of extreme winter mobility. Although soft riding, these traditional snow tires displayed imprecise handling, had low ultimate cornering limits, and made a lot of tire noise on dry pavement. Snow tires often carry the "Q" speed rating (99 mph), underlining the lack of dry road capability (although the NR10 was "T" speed rated, or 118 mph). It is well worth tolerating all this in areas with frequent heavy snow, and especially in rural areas where plowing is less frequent. Many see less frequent and lighter snow, however, and in urban areas roads are quickly plowed and salted. Here winter tires need to deal with wet slush and shallow packed snow rather than deep snow and thick ice layers, but mostly with dry pavement.

All season tires provide adequate mobility on slush and light snow and adequate handling properties on dry



Nokian NRW "All Weather Plus" tire.



Severe Service Emblem

pavement, but they provide neither the sporty handling on pavement of good summer tires nor the secure, sure footing on wintry surfaces one expects from true winter tires. Nokian, among other tire manufacturers, has in recent years produced what Nokian calls "All-Weather Plus" tires: "H" (130 mph) or higher speed rated winter tires which also bear the "severe service" emblem. The "M+S" sidewall marking on "all season" tires and "winter" tires appears at the discretion of the manufacturer, but the "severe service emblem" must be earned by passing a sequence of government mandated tests. All-Weather Plus tires are usually purchased in sizes to match the original equipment (OE) size, and thus promise both secure winter behavior and at least "all season tire" dry road handling properties.

As a final bonus, "All-Weather Plus" tires give you an opportunity to use the last bit of useful tread by driving them through the summer. 5/32" of tread is considered the minimum for winter tires, versus the 2/32" legal limit where the wear bars begin to show. Applying the "wear it out" strategy to traditional snow tires is an exercise in driving frustration, and the low speed rating points to potential warm weather problems. Having an H speed rating suggests

reasonable handling and safe summer motoring.

To help us evaluate the concept, Nokian provided us with a set of NRW tires in size 205/60R15 91H, the OE size for the 1997 9000 CSE. These were installed on the standard Saab 15X6 alloy wheels. By comparison, the 9000 was equipped with Aero (and 1998 CSE) OE size 205/55R16 91V NRV tires mounted on standard Saab 16X6.5 alloy wheels prior to mounting the winter tires. 205/60R15 91H Nokian NRH2 tires mounted on 15X7 Saab accessory wheels went on when the winter tires were removed. (See NINES #255 for an evaluation of Nokian summer tires.)

The performance of the NRWs in snow and icy conditions was exemplary. We happened to drive the Ohio Turnpike while a snow storm resulted in a slush and ice covered surface. There were many vehicles which had spun off the roadway, and we observed others having obvious difficulty in staying on track. With NRWs, the 9000 was stable at speed and had good turning and stopping traction.

The NRW's excellent behavior on ice and snow is to be expected from a Nokian winter tire. It's the dry road behavior that we experience the most, and here the performance was also very good. We found the dry road handling to be equivalent to that of a good "all season" tire; in fact, it gave little away to the NRH2 summer tire. The NRW has a lighter steering feel than the NRH2, is slightly less precise, and has a very slightly harder ride. Remarkably, the amount of tire noise is at the same low level as with the NRH2.

As an all around tire, the NRW is almost "too good", combining the dry road behavior we associate with a good all-season tire with the snow and ice performance of a good winter tire. For day-to-day driving, it fulfills the promise of all season tires, with special emphasis on winter capabilities. Do we recommend the NRW? We have in the past, but with the new WR (see the next page) Nokian promises an even higher level of performance. We hope to evaluate that promise this winter. The NRW is also being discontinued in many sizes, essentially forcing the issue.



Nokian WR "All-Weather Plus" tire

Nokian's NRW "All-Weather Plus" tire has developed from a square-shouldered "mostly snow" tire about 10 years ago into the current round shouldered version which combines good winter performance with good dry road behavior. 2001 saw the introduction of the WR, a new "All-Weather Plus" tire, in light truck sizes. Beginning this fall, most automobile tire sizes will be available in the WR as well, and the NRW will begin to disappear.

On the material front, the WR introduces the use of a new silica compound in Nokian tread rubber. This additive, called High Dispersion Silica, or HD Silica, results in better wet traction, lower rolling resistance, and longer life than either

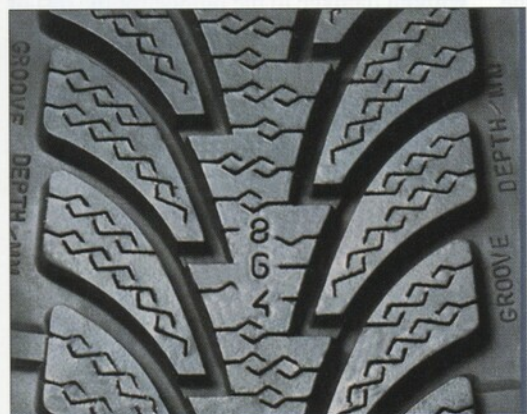

Close up of the WR tread, showing the Driving Safety Indicator (DSI) numbers molded into the tread and the geometry of the "Haka Siping".

current silica/carbon black blends or pure carbon black blends. Earlier silica/carbon black blends enhanced low temperature flexibility at the expense of traction and tread life, as compared to pure carbon black.

Convenience features seen on other Nokian tires are implemented on the WR. The Driving Safety Indicator is a sequence of numbers molded into the tread at varying depths. As the tread wears, the shallower numbers wear away, thus indicating at a glance the amount of tread remaining. DSI was first implemented in the Nokian NRH2, and has since been included in the NRZi and NRV summer tires. Another convenience feature from the NRZi is the Info Pin, a "button" on the sidewall which changes color from green to black as the temperature approaches the freezing point. The Info Pin can also be turned to indicate the tire's position on the car, removing the guesswork during seasonal tire changeover.

Unique to the WR is "Haka Siping". "Sipes" are the thin cut-like lines molded into the tire's tread, as opposed to the wide grooves which define the tread's "ribs" and "blocks". Haka Siping exploits the tendency for rubber adjacent to the sipes to wear more rapidly than the rest of the tread. By arranging overlapping "S" shaped sipes, the result is a surface that wears to form hundreds of tiny "bumps". These bumps increase traction on snow and ice as if they were studs without affecting dry road performance or damaging the roadway.

The WR continues Nokian's trademark unidirectional tread pattern with a more contemporary looking and streamlined version, and carries the Severe Service Emblem. Like all automobile and light truck Nokians it features Jointless Nylon Belt over steel belted radial construction. The WR is available in the full range of Saab OE sizes, including the 9⁵ Aero's 225/45R17 XL, but with a "V" (up to 150 MPH) speed rating. We wouldn't recommend such a low profile in a winter tire in our area, though. Besides the issue of traction in snow and ice,

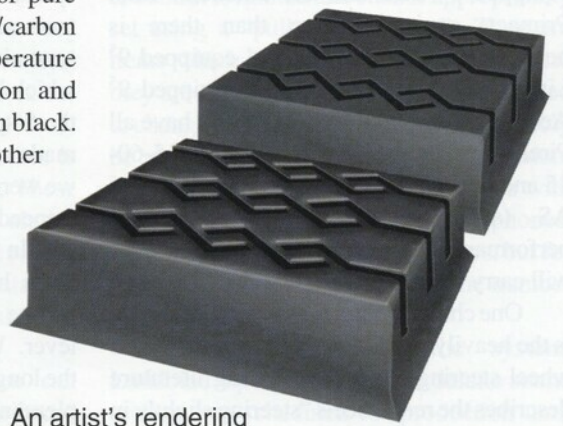

An artist's rendering of the Haka Sipe concept. The upper block shows the tire as molded; the lower block shows the shape after some wear has occurred.

which the low profile tire can provide, there is the problem of potholes which form during freeze/thaw cycles. The potholes are sometimes hidden under snow and slush, and they make short work of rims when very low profile tires are mounted.

To emphasize the WR's position as a winter-capable all season tire, Nokian has left the "Hakkapeliitta" name off the sidewall, adorning it instead with the UTQG (Universal Tire Quality Grading) symbols that snow tires are exempt from displaying. Those numbers on automobile tires are 400-420 (depending on size) A - A, a credible performance for an all season tire.

Photographs and graphic courtesy of Nokian Tyres, Inc.

FEATURE COMPARISON



A graphic representation of the degree of improvement of the WR over the excellent NRW.

equipped 9³ Arc and the Michelin Pilot Primacy equipped Aero than there is between the Michelin MXV-4 equipped 9⁵ Linear and the Pilot Primacy Equipped 9⁵ Aero. The production vehicles will have all Pirelli tires, however. The Linear's 215-60-15 and the Arc's 215-55-16 tires will be P-6 AS (all season), and the 225-45-17 performance package, standard on Vector, will carry P-Zero Rosso.

One characteristic of the rear suspension is the heavily promoted "ReAxs passive rear wheel steering." The marketing literature describes the rear wheels "steering slightly in the opposite direction of the front wheels" to improve handling. Swartz and Fredén described the suspension as having "rear wheel roll oversteer" and "rear wheel side sway oversteer," both calibrated to "help" the car around a corner without diminishing stability. Described either way, the designers have successfully provided a chassis that is close to neutral, not needing to be pushed hard through a turn, but steady and stable at all speeds.

The manual transmission cars have a newly designed cable shift mechanism attached to a "modified" 5-speed or a totally new 6-speed, depending on the model. The 5-speed modifications include the entire gear change mechanism, to go with the cable shifter, along with a new synchronizer

synchronizers will be like new. The 6-speed transmission has one primary and two secondary gear shafts, resulting in a gearbox which is both shorter and bigger around than the 5-speed. We asked if the 6 speed is also made with carbon synchronizer rings, and we were told that they weren't needed on the 6 speed, due to its superior design.

In operation, the cable shift transmissions had short, positive throws, with no engine vibration transmitted to the shift lever. We check tested a 2002 9³, and found the long, light throw of the rod shifter to be as pleasant in its way as the short, crisp action of the new system, and more familiar as well. Interestingly, if you were blindfolded, told to work the gear levers, and then to choose which car had the cable shifter and which car had the solid rod linkage, you would probably choose the 2002 car as having a cable shifter. The footwell in the new car is much wider, allowing the pedals to be spaced wider apart. We find the tight footwell in the old car to be no problem for our dainty editorial (size 7 °) feet, and the close pedal spacing makes heel-and-toe easier for us.

Back at the static display, we were impressed by what's under the skin. Malkusson showed how the new car combines a rugged, multiple load path front body design with a triple stage restraint strategy. For low impact crashes, the seatbelt tensioners activate, but the "air bags" do not. The airbags themselves are dual-stage, adapting the rate of bag deployment according to the crash intensity for moderate to severe impacts. The seat-mounted torso restraints activate only in a side impact, but the "curtain" restraints activate whenever the front bags deploy as well as during side impacts. Crash tests show a tendency for head contact on the "B" pillar during offset frontal crashes, which the curtain restraint would cushion.

The multi-stage crash response philosophy carries over to the body itself. The front bumper is built up of Saab's traditional self-restoring structure: a deep "C" section bumper beam filled with a resilient plastic compound that maintains the appropriate shape for the bumper skin. In the cut away display, the plastic foam feels like polypropylene, and it feels quite

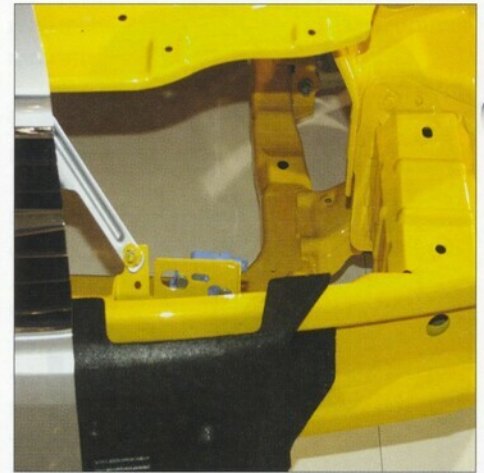

Self-restoring front bumper combines a resilient plastic foam with a high-strength steel support channel beam. resilient. The front bumper beam itself is made from high-strength steel, said to have a yield stress level which is 4 times that of



Cable shift levers and "pendulum" mount. Note weighted lever for proper "fore-aft" shift lever feel. design. The gears, bearings, shafts, and case are identical to the older gearbox. The synchronizers in the 5-speed box are now made from carbon fiber, and are similar to the friction material used in Formula 1 race car brakes. Widmark told us that when these cars are scrapped at the end of their lives, the



Dashboard and steering wheel, side curtain, and seat mounted torso "air bag" restraints.

mild steel (80,000 psi versus 20,000). According to the design specification, the bumper can withstand a 5 mph impact without damage to the bumper or the rest of the car.



Triple steel structure of the "B" pillar.



“Crash box” protects the unibody from damage in moderate level impacts.

The front bumper beam is attached to the rest of the body through a bolt-on “crash box”. During intermediate intensity impacts, corresponding to wall impacts up to 9 mph, the crash box undergoes a controlled collapse, absorbing crash energy and protecting the main body structure from damage. By design, there will be no deformation to the unibody during an intermediate crash: only the crash box, bolt on fenders and hood, and front lights and the bumper itself are exposed to damage.

For severe impacts, 10 mph and above, the crumple zones absorb the impact while the safety cage maintains integrity. The roof rails and “B” pillar are immensely strong, with a double “frame within a frame”



A sturdy steel tube supports the dashboard

running up the “A” pillar and along the roof, and a third frame member welded into the “B” pillar. The dash support beam is a large diameter, heavy wall steel tube. Magnesium castings are being used for this function in many other cars for their combination of light weight and high stiffness. During a crash, however, a steel tube such as Saab uses will remain intact while a magnesium casting

tends to crack.

Aluminum is used primarily to reduce unsprung weight in the brake calipers, wheel hubs, and suspension arms. In addition, the engine cradle is “hydroformed” from aluminum tubing, the rear bumper beam is aluminum, and the hood is aluminum. These components, combined with the all aluminum engine, allow the vehicle weight to stay below the old model despite the substantial increase in body strength and stiffness and a marginal increase in vehicle size.

The center console electronics can control many functions through the on-board



Resilient foam knee pad is supported by collapsible steel support.

computer using a “push and turn” knob and the computer display. For example, the three seat heater settings, set using a dashboard 4 position switch in the 9000 and 95, are selected through the electronic display in the new car. The number of parameters subject



Resilient foam prevents “submarining” and prevents injury from seat structure.

to control is limited and each is appropriately set using a “pull down menu.” They are items which are set only occasionally, and they are not settings one might feel the need to change while driving. There will probably be more “multi-function controls” in future models as people become more familiar with such menu driven settings in cell phones, television sets, and even refrigerators, but for now Saab has wisely restrained the number of available settings.

When demonstrating the system, Lundblad apologized that the deluxe sound system, not scheduled for production until January, was still in the “prototype” stage. It sounded great to us, but he asserted that there would be improvements before the system’s introduction. For example, the bass control affected tones into the lower midrange, which would be corrected. Considering that up until the mid 1980s Saab did not put radios in at the factory, (radios were “port installed” in the USA and “dealer installed” in most other markets) they have become amazingly particular about sound quality.

Saab has become particular about cupholders as well. The “butterfly” cupholder in the new 9³ ranks right with the rotating unit in the 9⁵ in entertainment value, and holds larger cups as well. As with radios, Saab was “dragged kicking and screaming” into providing cupholders, but now endeavors to provide a “best in class” design for them.

As much as the design of the car, the assembly line for the 9³ Sport Sedan is brand new. Production occurs in 4 distinct stages: pressing, welding, paint and prep, and mechanical assembly. At every stage, new procedures to ensure quality have been implemented.

Most, if not all, of the small stampings are purchased, and the big floorpan (for both the 9⁵ and 9³) is supplied by GM. That leaves all the outer panels and structural parts, which are unique to Saab and produced on-site. The press line produces stamped parts in lots of 1000 to supply the needs of both the 9⁵ and 9³ assembly line, which is between 2 and 4 days’ worth of inventory. By most standards, those are pretty small parts runs. The time to switch dies in each press averages 10 minutes, which is relatively quick.

Between the ballet of the robot arms and sparks and smells of the welding itself, body welding is arguably the most dramatic activity

2002 Pikes Peak Hill Climb

that takes place in an auto plant. Unfortunately the assembly line was not running when we toured the factory, so we did not see the bodies being welded together. We did see bodies in various stages of completion, and the station where every "body in white" (jargon for a welded-up but not-yet-painted body) receives a 100% inspection. We assume that statistical quality control is employed to optimize the welding process.

The body, doors, hood, and trunk lid are painted together. The production scheduling computer organizes production so that cars of the same color are produced consecutively to the maximum extent possible. This saves time and reduces waste because the paint sprayers don't need to be cleaned as often.

Mechanical assembly includes the pre-assembly of power train and rear suspension cradles, their attachment to the vehicle, and the installation of all the interior and underside components. Step 1 is the removal of the newly painted doors to ease the installation of the interior and the assembly of door components. The doors follow their own path through the assembly building to be reattached to their respective body at the end of assembly. There are several inspection stations along the assembly line, and like the body in white, 100% inspection is the rule. In addition, the tools for critical assembly steps are linked directly to the computers overseeing the production line. A vehicle can not move from an assembly station until that tool is operated on the car. All this is designed to produce a vehicle with best-in-class quality.

In its marketing session, Saab was very explicit about the customers it is targeting with this car. The premium compact car market is growing and profitable, and sedans comprise over 60% of the cars sold in this segment. The remaining models sold, in order of volume, are station wagons, convertibles, and finally hatchbacks with but 2% of the total. Those, of course, are mostly Saabs. It is Saab's plan to compete first for the 60% of the "premium compact" market comprised of sedans, against BMW's "3" series, Audi's A4, Volvo's S60, Jaguar's "X" models, Mercedes' "C" class, and cars from Lexus, Accura, and Infiniti. The convertible, which has accounted for as much as 40% of Saab's 9³ sales, will be the next model introduced, followed in the year or two after that by 4WD and FWD versions of a 5-door variant.

Photographs by the author.



Per Eklund at the 2002 Pikes Peak International Hill Climb. *Photograph courtesy of Saab Cars USA, Inc.*

On Saturday, June 29th Swedish rallycross racer Per Eklund piloted the most powerful modified Saab ever, an all-wheel-drive 750-hp Saab 9-3 Viggen, to victory in the Unlimited Class at the 2002 Pikes Peak International Hill Climb. Eklund clocked the second fastest overall time of the day in the 80th running of the race. He claimed his second class victory in three Pikes Peak visits with a personal best time of 11:13.24, bettering his 2000 Pike's Peak Open Class winning time by over 8 seconds. Eklund and his Saab's performance defeated the second place Unlimited Class entry and long-time Swedish rival Stig Blomqvist by over 34 seconds (11:47.45).

"The road surface was very slippery this year and at times it felt like I was driving on ice, but the Saab engine and rest of the drivetrain performed perfectly," said Eklund. "In fact, the engine coolant and turbo intercooler temperatures were so much lower than we expected that we could have probably run another .5 bar (over 7 psi) of boost pressure and run quicker with a lot more horsepower."

The last four miles of the treacherous course were particularly attention-grabbing for Eklund as his car's brake fluid boiled and the pedal went to the floor. "I guess we paid so much attention to gaining improved downforce by adding the front wings to the car this year that we took away needed airflow to cool the front brakes. It's tough

enough driving this mountain with brakes." Eklund said, "I'd rather not have to drive up here again without them, but everything worked out fantastic."

For this year's entry in the Unlimited Class, Eklund and his team fine-tuned the same race car that tackled the mountain the two previous races. It's the most powerful Saab ever, an all-wheel-drive 9-3 Viggen with a Saab 2.0-liter engine that delivers 750 horsepower at 8,000 rpm and 545 lb.-ft. of torque at 6,500 rpm. With this amount of power, all-wheel drive and a 6-speed transmission, the 9-3 Viggen's acceleration is in the Formula One class: 0-60 mph in 2.3 seconds. Running in the Unlimited Class this year allowed Eklund's team add front and rear wings and other aerodynamic aids to press the car more firmly to the tarmac and gravel road surface.

The car is geared for a top speed of 155 mph. The vehicle is constructed on a sturdy tubular frame that gives both high torsional stiffness and good crash protection. Eklund has been competing in rallies, rallycross and other races since the early 1960s, most often behind the wheel of a Saab. Throughout the 1970s, Eklund was one of Saab's most successful factory drivers, and won the 1976 Swedish Rally in a Saab 96. In an impressive rookie performance, he won the open class at Pikes Peak in 2000 with a class-record-setting time of 11:21.38, the second fastest overall time of the day.

Story compiled from media releases.

Saab Swap

Saabs For Sale

1995 900SE Turbo Eucalyptus Green - Trans: Manual - Mileage: 32,000 - Price: \$9900. low mileage cream-puff! Cream leather interior and burl wood trim on dash and doors. 3 door coupe. one owner. All records and receipts. Garaged, body and interior fabulous. Rudolph Feuerstein, Scotch Plains NJ (908) 754-6867

1991 900 Turbo Convertible Platana Gray - Trans: Manual - Mileage: 50,000 - Price: \$18,000 Limited Edition Convertible - 400 copies to US in 1991. 5-spd, turbo, SPG trims& rims, Platana Grey, always garaged, stored winters, 50,000 miles, in excellent condition. New 6 changer CD last year, new clutch this summer. Kathy Davis, S Burlington VT. kathy@kingstreetyouth.org (802) 863-2037

1988 900 SPG Grey - Trans: Manual - 195,000+ - Price: \$5,800. factory whale tail. All since fall, 200: new updated tranny, clutch, MSS exhaust, f&r pads rotors, stainless steel brake lines, K&N filter, SPG9 APC box, 3.0 bar fpr, CV joints, ball joints, motor mounts, Euro spec headlights, short shift kit, 205/55 Z R15 RE730s on Ronal RT twin wheels, 195/60 HR15 Michelin Pilot Alpin on stock SPG wheels, head gasket repair, new hoses throughout engine bay. Interior and exterior are excellent. **TSN** Samuel C.K. Lee, Wynnewood PA sklee@hotmail.com (215) 430-4083 (w) - (610) 658-7294 (h)

1987 900S Malachite Green - Trans: Manual - Mileage: 165,000 - Price: \$2800 obo, 3 door hatchback "S" model. All maintenance records. Second owner. Southern car. No rust. Mechanic owned. Everything works. Oil changed every 3000 miles. Ball joints, tie rod ends, a/c compressor, exhaust system, C.V. boots, brake master cylinder, clutch, heater valve, front & rear main seals all replaced recently. 5 Ronal Minilite wheels included. **TSN** David Mondecarr, Marietta GA Mondecarr@msn.com (770) 565-7289

1980 900 Turbo New or rebuilt: brakes, clutch, transmission, head gasket, fuel pump, water pump, ball joints, suspension bushings, headliner, radio and speakers. EMS manual rack, straight, solid body. Needs paint. Jim Phillips, Akron, OH (330) 376-3003 (W), 330-882-6008 (H), or Steve Goldberger, nines@neo.rr.com.

1971 Sonett Purple - Trans: Manual - Mileage: 80k - Price: \$700 100% Complete and straight car. All glass perfect. Some rust rocker panels, replacement panels \$100. Ran fair when parked in '99, it can be started. In Colorado since new. Soccerballs, but I have a lead on original Campagnolo mag wheels. Kevin Dickson, Denver CO kevintdickson@hotmail.com

1971 96 V4 Tan, 160k miles, \$4800.00 exterior restored, interior very nice, recent valve job, tune-up, Weber, exhaust, electronic ignition, brake work, extra pirts with a 57k mile parts car included. Lawrence W. Pratt, New Hampshire. (603) 284-7367 6-9 pm

1970 99 2-Door Sedan Black - Trans: Manual - Mileage: 101.826 - Price: \$3500 obo Classic Rust Free Colorado car. Ran when I parked it. Perfect restoration project. Everything there. Rare metal dash with pad. Interior is in fair condition, will need to be redone. All glass is good. Will consider all offers. **TSN** Carl E. Hammerberg Jr, Duluth MN h1graphix@aol.com (218) 525-7498

1967 96 Blue - Trans: Manual - Price: \$5750 Saab 96 Vintage Rally car. Two-stroke with oil injection and triple carbs. Excellent condition with all rally equipment to run European-style Historic Rallies. Rebuilt engine, suspension, special exhaust, brakes, by the Factory Museum in Trollhatten and just about everything tweaked. In storage at the Factory Museum, or I will arrange return. **TSN** Kevin Clemens, Hilliard OH wrrr@aol.com (614) 921-9730

Quantum Formula Junior - Slightly modified in early 60s to take BMC "A" motor. Raced with HMSA and CSRG since 91. Has Carrera coil-over shocks/springs. Red with white striping. Spares, trailer, delivery negotiable. Will sell as roller for easy conversion back to Saab motor or with current engine having Elgin cam, Weber carb, Venolia pistons, Mallory dual point distributor. \$10,000 or less depending on trailer, spares, delivery, etc. Marty, CA (650) 593-4186 or (209) 296-5801.

Parts & Miscellaneous For Sale

New Old Stock front turn/park lenses '65-68 Saab 95/96, good used Sonett III tail lamp assemblies, 1 very good Sonett V4 hood ass'y. Jack Ashcraft, 2030 Grey Eagle Drive, Medford, OR 97501 jackashcraft@prodigy.net (541) 779-073

Aero Rims with Michelin Pilot Tires Set of 4 super aero rims with Michelin pilot tires. The rims are 5 lug and are 16x6.5 from a 1997 Talladega 900. They fit many applications but not classic 900's from '88-'93. Good condition with slight curb rash on 2 of them, The tire's tread is good and evenly worn to about 1/2 tread left. \$500 with buyer to pay shipping if necessary. John Roth, Aptos CA drupchen@yahoo.com

9-5 Tire and Rim Package Tires are: 225/45/ZR17 Bridgestone RE730. Rims are ASA EM9 17". Package can be seen on The Tire Rack website under "Shop For Wheels". Practically new. \$1200 new, will sell for \$750. Will deliver to "buyer" up to 75 miles. Anxious Seller. Contact: Robert Quinn, Forestdale MA robertquinnco@aol.com (508) 367-3599

SPG 900 Turbo Parts Parting out 1987 SPG 4 3 SPOKE Wheels @\$375, 10 panel ground effects EC \$400, SPG Springs \$125, SPG Bumper extensions, 4 pcs \$110, Motor and transmission, \$1200, SPG Springs \$110. Very good interior. Buyer pays shipping. Most other parts still available, write me with your needs. Robert OMea, Lake Oswego OR Robert2001@aol.com (503) 697-6562

9000 Aero rims, silver with grey centers, 6.5"Jx16, Saab p/n 8967036. Quantity 4, Excellent condition. \$250 each when new, \$560 for all 4. Rich Bohn, Hollis, NH. 603-468-2108.

EMS Mags with Center Caps 1974 EMS mags 4 with org-center caps, 5 blue silver letters, good shape. \$400. Mark Dupry, Pleasant Prairie WI mark9705@aol.com (262) 496-1648

NINES complete April, 1985 through Nov-Dec, 2001. Issues 126-254. \$125. Jim Oliver, Butler, PA. (724) 258-8294.

1984 - 1993 Saab parts. Almost everything, SRS, ABS, Heads, Transmissions, Suspensions, Lower A-Arms, All high quality. Can provide installation with warranty. Also provide mobile Saab Service in Los Angeles. Loaner cars, open 7 days a week, labor warranty, factory trained! Customer oriented - we come to you! Call for details. Walter Wong - Saab Mobile Service, Los Angeles CA

Books & Service Manuals: 9000 service manual: \$35. 900 (79-98, specify year) service manuals: \$15-\$48 earlier models also available. See www.books4cars.com or call (206) 721-3077, or Toll Free 888-380-9277. Alex Voss, 4850, 37th Ave. So. Seattle, WA. 98118.

Wanted

Wanted: Saab 99 Looking for a Saab 99 - Will consider any year or model. Preferably an EMS. Needs to be drivable. If anyone has such a car in the Rocky Mountain region, I'd like the opportunity to check it out. Thanks. Luke Beatty, Denver CO lbeatty@wand.com (303) 523-2868

Wanted: 1985-93 Saab 900 SPG Turbo SPG Wanted!!! SPG Wanted!!! SPG Wanted!!! 1985 through 1993. Any Condition wanted. Rusted, Wrecked, beautiful, etc. Looking in South Eastern U.S. preferably. Larry Pate, Chapin SC ClarryPate@yahoo.com (803) 414-1620

"TSN" indicates a photo is available at The Saab Network Classifieds: <http://www.saabnet.com/tsn/class/>

We've devoted a lot of space in this issue to the launch of the new 9-3 Sports Sedan, especially considering the amount of space devoted in the last issue to the press releases. We've done



so because this really is a milestone product for Saab. It marks Saab's total integration into General Motors, meaning that virtually every part of the car has been created with Saab involvement from the very first. We reported in NINES #257 how the 1994 900 was virtually a completed body in search of a chassis before the joint venture between Saab and GM was announced. In the development of the 9-5, the front body structure was completed by Saab prior to the selection of the chassis, and the chassis was well into its development before Saab became involved. Engines and transmissions in both cars were independently designed Saab products, and in the case of the 1994 900 they were adapted to fit the chassis. Now with the 2003 9-3, an entirely new chassis has been designed from the start to accommodate Saab's requirements, no doubt to the benefit of the other GM divisions that will use it. Saab has participated in, and from all appearances lead in the development of an entirely new 4 cylinder engine, again to the benefit of the other GM divisions that will use it.

There is also a lot to tell. There are real innovations in terms of structure, suspension, and safety systems that are unique to Saab and which won't be described in any of the "popular press," either magazine or newspaper. There still wasn't room for all of it; a whole section on the power train and suspension details will be printed in the next issue. Finally, we want our readers to really feel as if they had attended the press launch after reading the story. If you felt your eyelids closing, that was the jet lag.

Schedule and space limitations mean that trying to cover both the New 9-3 launch and the convention in this issue would result in poor and skimpy coverage of both. Our November/December issue will be heavily devoted to convention coverage, and this year there is even more than usual to cover. Added to the seminars, autocross, concours, auction,

keynote address, and the reacquaintance among old friends were the track event and the first business meeting of the new Saab Club of North America. Kings Island Resort with the nearby Air Force Museum was a wonderful family location where Saab enthusiasts were also able to be roller-coaster evaluators and flight history buffs.

We are delighted to have more color in this issue, thanks to those advertisers who wish to appear in color. We think NINES will become more spectacular and exciting and we're working with different layout changes as we learn how to get the most benefit from our color pages.

Our cover this issue has a bit of serendipity in it. During the day's drive, we stopped when we saw some of our colleagues photographing one of the few red cars (most were black or silver) in front of a Swedish farm building (that stone arched ramp behind the car leads to the second floor). We stopped, and I took some shots too. After we returned,

Norma's mother sent a clipping from the Toronto Star containing Jerry Malloy's report on the New 9-3, including (you guessed it) photos of the red 9-3 Aero in front of a Swedish farm building.

Finally, let me add my congratulations to the newly elected Officers and appointed Board of Trustee members of the Saab Club of North America. They are at work now creating the organizational documents that will carry the Club forward. We think that the back page of NINES' cover wrap would be an excellent choice for the official ballot when it comes to approval of the By-laws and future elections of officers and trustees. It will be designed so the address label can be separated from the ballot after certification that the ballot belongs to an SCNA member. Using the cover wrap as the ballot saves the Club the time and expense of a separate mailing, and makes it unlikely that the "ballot" will be misplaced. The address label should state "SCNA" if you are a member, so check the label on this issue and make sure you are properly identified.

GREEN DIAMOND

TRACTION TIRES

From Iceland... The first All-Season tire with Ice-biting Traction



The Ultimate ALL-Weather Tire

- Ice-biting traction of a studded tire.
- Improved wet road traction.
- Quiet and comfortable ride.
- All-Season tire mileage.
- No road wear or noise.
- Invented in Iceland – Proven in Sweden.

The only TRUE ALL-Season tire.

Green Diamond tires represent the most significant advancement in tire technology since the development of the steel-belted radial. Through a patented process, each Green Diamond Tire contains thousands of carbide granules (Green Diamonds) embedded through out the tread of the tire. The carbides function as miniature studs. Green Diamond tires (**all-season and snow** tread designs) out perform even conventional studded snow tires, on ice, hard-packed snow, and wet pavement.



185/65R15	\$55.40
195/65R15	\$55.40
195/60R15	\$54.68
205/60R15	\$58.75
205/55R16	\$71.40

(Other all-season and winter sizes also available)

Order on-line at:
www.GreenDiamondDirect.com
 (715)355-8527

30-Day money back guarantee

If you are not using original SAAB parts,
**YOU MUST BE USING
SCAN-TECH SWEDEN PARTS**



Scan-Tech Sweden is the world's largest
manufacturer and supplier of
SAAB aftermarket parts.

Ask for us by name!



www.ScanTechSweden.com



KACHINA SAAB



OF SCOTTSDALE
Arizona's Authorized SAAB Dealer

Sales • Parts • Service



Over 20,000 OEM parts available

Factory trained SAAB Parts Specialists

SAAB Master Technicians

Most orders shipped same day
with Next Day Air available

Monday through Friday 7:00 a.m. to 5:30 p.m.

Saturday 8:00 a.m. to 1:00 p.m.

KACHINA SAAB

1200 N. SCOTTSDALE ROAD • SCOTTSDALE, ARIZONA 85257



(800) 955-1205
(480) 941-9600

We accept all major credit cards