

#238

\$5.95

# Nines

The **SAAB** Club Magazine



**UP FRONT**

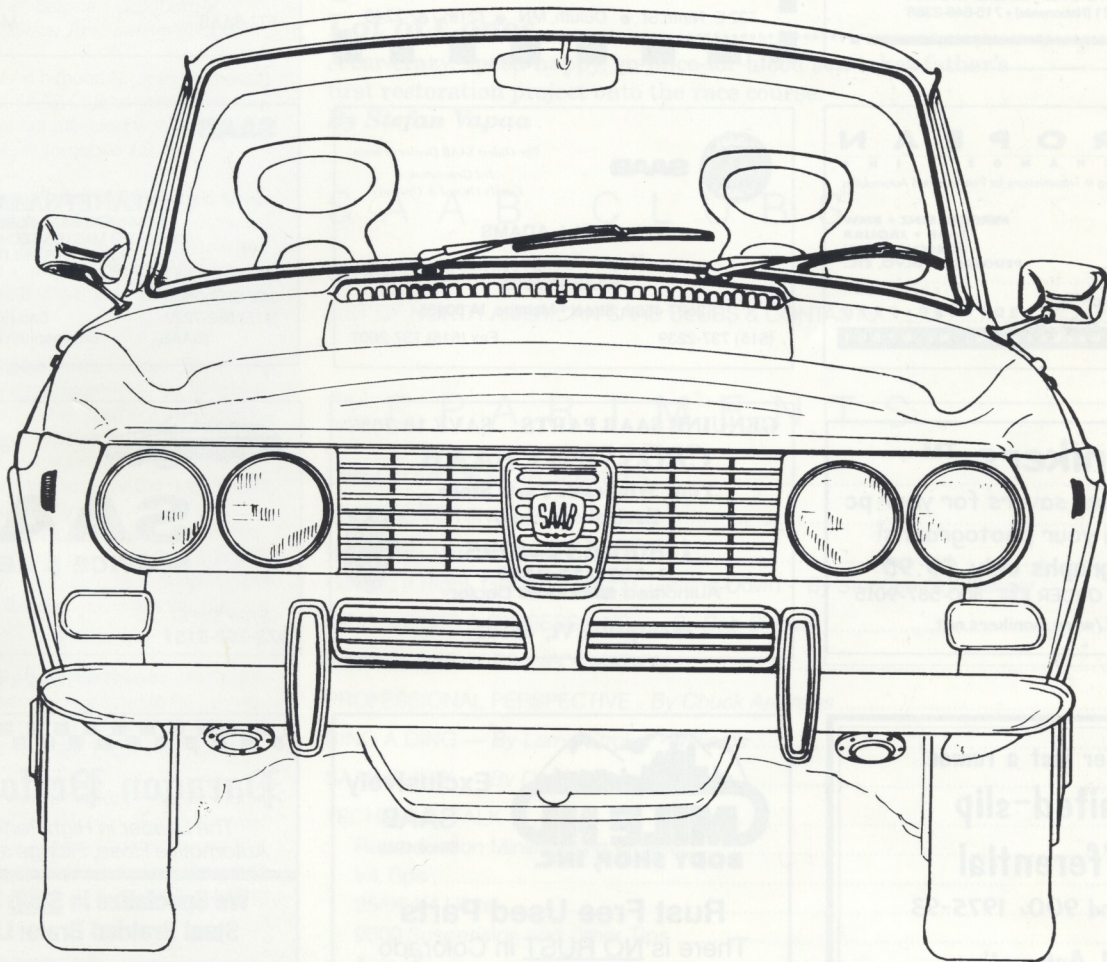

R. M. GROSSMAN  
c. 72

**ISSUE NO. 1**

**MARCH, 1973**



# Directory of Saab Services



PHONE: (203) 284-8989  
FAX: (203) 269-9679  
WWW.LUXURYCARS.COM

**IMPORTS UNLIMITED**  
605 N. COLONY RD.  
WALLINGFORD, CT. 06492

MIKE CARO                      IMPORTED AND DOMESTIC  
PRESIDENT                      AUTOMOBILES

**Overseas Speedometer**                      1-800-444-0292  
512-329-8200  
Fax 512-306-0276  
www.speedometer.com

**Rick Borth, Owner**  
Cable-Driven & Electronic Units • MB Quartz Clocks

- Audi • BMW • Porsche • Mercedes • Saab
- Volkswagen • Volvo • BMW Motorcycles

Please U.P.S. to: 100 Wallis Drive, Austin, Texas 78746

Tim Brown                      SAAB SPECIALISTS                      Kevin Booth



We want you and your car to be happy

Full Service Auto Repairs

727 Furnace Hill Pike, Lititz, PA 17543                      (717) 626-5264

**Strandberg's Auto**  
Volvo Specialist  
Parts For European Cars - Rebuilders

John & Kevin Strandberg

P.O. Box 430 • 615 Polk • Centuria, WI 54824  
800-448-5121 (Nationwide) • 715-646-2388

Mark Strohm                      Jeff Hofslund

**FOREIGN AFFAIRS**



of Duluth, Inc.  
722 E. Ninth St • Duluth, MN • (218) 722-2246

**saabworks**  
Parts Service Sales

**Jeff Moylan**  
Parts Specialist

760 Elm Street  
Milford, NH 03055

672-SAAB



**EUROPEAN EXCHANGE, INC.**  
Specializing in Transmissions for Fine Imported Automobiles

MERCEDES BENZ • BMW  
SAAB • JAGUAR  
PORSCHE • AUDI  
PEUGEOT • VOLVO, ETC.

Rich Varjan  
201-489-7770  
155 Lodi St., Hackensack, NJ 07601



The Oldest SAAB Dealer in Iowa  
3rd Generation -  
Family Owned & Operated

**MARTY J. ADAMS**  
Meyer Garage, Inc.  
SAAB Imports

2687 480th Street • McIntire, IA 50455  
(515) 737-2239                      Fax (515) 737-2601

**SAAB**                      

**PLANET SAAAB**  
COMPLETE SAAB SERVICE  
CERTIFIED MASTER TECHNICIAN  
FACTORY TRAINED

JAY SITTON                      45 Dore Street  
(415) 552-7222                      San Francisco, CA 94103  
(SAAB)                      Between 9th & 10th, Off Howard

**Monikers™**  
custom screen savers for your pc  
featuring your photographs!  
**5 photographs only \$9.95**  
CALL TODAY FOR ORDER KIT 800-587-9015  
<http://www.monikers.net>

GENUINE SAAB PARTS    SAVE 10-20%  
**CROSSWAY SAAB**  
Your Wholesale Parts Store  
Exclusively Saab

**1-800-639-4095**  
1-802-223-9583  
Authorized SAAB Dealer



Montpellier Vt, 05602



**SAAB**  
SERVICE & REPAIR

JERRY SWEET                      Sweet Motors  
973-252-5151                      379 U.S. Highway 46  
Mine Hill, NJ 07803

No longer just a rumor!  
**Limited-slip Differential**  
fits 99 and 900, 1975-93

**S&J Automotive**  
1491 Howell Mill Rd  
Atlanta GA 30318  
**404-351-SAAB**  
[jack@mindspring.com](mailto:jack@mindspring.com)



Exclusively SAAB  
Since 1969

**Rust Free Used Parts**  
There is **NO RUST** in Colorado  
125 SAAB'S TO PICK FROM

**1-800-757-7222**

519 Lipan St - Denver, Colorado 80204-4906  
Phone (303)595-4646 - FAX (303)595-0124  
[www.milehdbodysop.com](http://www.milehdbodysop.com)

**Paragon Performance**  
The Leader in High Performance  
Automotive Hose, Fittings and Adapters

**We Specialize in Saab Stainless Steel Braided Brake Line Kits!**  
Prices Start at \$69.00 for a 4 line kit

We also offer Stainless Steel Braided Hose, Aluminum Fittings and Adapters for Fuel, Oil & Transmission Lines  
Come visit us at:  
<http://www.paragonperformance.com>  
1-800-270-0333



# Contents

AUGUST 1998



## SAAB Club of North America

7675 Bear Trap Jct.  
Saginaw, MN 55779

Phone: 218/ 729-0826,  
9am - 6pm Mon - Fri CT  
Fax: 218/ 729-0827

CompuServe E-mail: SaabClub  
Internet E-mail: tim@saabclub.com  
Web Site: <http://www.saabclub.com>

**NINES Editor & Publisher:**  
*Tim Winker*

**Editorial Ass't / Membership**  
*Chris Durkin*

**Layout**  
*Natasha Medwedeff, Time Ink*

**Contributing editors & photographers**  
*Chuck Andrews, Seth Benglesdorf,  
Rick Corwine, Stephen Goldberger,  
Bob Sinclair, Bruce Turk, Larry Williams*

**NINES** is published bimonthly (or thereabouts) as a service of the SAAB Club of North America. The SAAB Club is not affiliated with Saab Cars USA, Inc. or Saab Automobile AB.

**All material copyright 1998, SAAB Club of North America.** Material may not be reproduced without permission. The opinions and views expressed in articles are not necessarily those of the SAAB Club and its magazine, NINES.

**Editorial contributions** are welcome. All material submitted is assumed to be for publication unless clearly labeled otherwise. Double-spaced typewritten articles are preferred, but most anything is acceptable. We cannot answer every inquiry and reserve the right to edit materials submitted.

Those wishing to submit material on 3 1/2" IBM-formatted disks, please provide ASCII text files (<filename>.TXT), and include a printed hard copy. Enclose a SASE if you want the disk returned.

**Mechanical Specifications:** Magazine prints at 133 line screen. Acceptable file formats: EPS files, please include all fonts - Macintosh and IBM compatible. TIFF, PICT, BMP, & WMF.

**Photos:** Preferred format for photos is black-and-white, in 5"x7" or 8"x10". Good contrast color photos can be accommodated, no smaller than 3+"x5", please. Photos used on the cover will be rewarded with a one year subscription to NINES.

**CHANGE OF ADDRESS:** Eight weeks notice is required for change of address. Please mail new address and old address, including zip codes, to the SAAB Club at the address above.

**RETURNED CHECKS:** There will be a fee of \$10.00 charged for checks returned for any reason.

## FEATURES

### It's About Image ..... 26

When Saab AB turned 60 years old, the company logo was slightly changed.  
*By Len Lonnegren*

### 25 Years. Or is it 27? Or 24? ..... 28

The early history of the Saab Club of North America

### Springtime in Alaska ..... 30

A pair of 9-3s were driven from Prudhoe Bay, Alaska, to Key West, Florida, in just over 96 hours.  
*By Tim Winker*

### A Hardheaded Review of the 9-5..... 34

*By Joel M. Kauffman*

### Lot of Cones ..... 38

A car-crazy, speed-happy, go-juice-for-blood son takes father's first restoration project onto the race course.  
*By Stefan Vapaa*

## SAAB CLUBS

CLUBS CALENDAR ..... 23

LIST OF NORTH AMERICAN SAAB CLUBS & CONTACTS ..... 23

## DEPARTMENTS

DIRECTORY OF SAAB SERVICES ..... 2

LETTERS TO NINES ..... 4

NOTES IN THE MARGIN ..... 6

Getting It Right, Getting it Wrong, Getting Down - *By Stephen Goldberger*

DISCOURSES & DIGRESSIONS — *By Bob Sinclair* ..... 10

PARTS & SERVICES INFORMATION ..... 12

PROFESSIONAL PERSPECTIVE - *By Chuck Andrews* ..... 14

RING A DING — *By Larry "Stroker" Williams* ..... 15

SAAB KLINIK — *By Doctor Nio* ..... 16

TECHNICAL TALK ..... 18

Reproduction Minilite-style Wheels ..... 18

V4 Tips ..... 18

95/96 V4 Hints ..... 18

9000 Suspension and Other Tips ..... 19

Auto PC ..... 20

Mini Stock Racing ..... 40

SAAB NEWS — 9-5 Reviews ..... 24

SAAB SWAP — Classified Ads ..... 42

REAR VIEW — *By Tim Winker, Editor/Publisher* ..... 46



# Letters to NINES

## **"Stroker" Williams Remembered**

Over the past winter months, I have been "planning" our Summer Saab picnic. One of my thoughts was making a mental list of those who would be here. Iowa is only perhaps a bit over one thousand miles away, so I half expected Larry to show up for the afternoon.

Larry was one of the regulars that showed up at every convention, except for Kirkwood '96. He had said that he would not be going, but many of us looked and waited for him well into Saturday afternoon.

"Stroker" would always arrive late afternoon of Friday. When everyone spotted Larry and Sadie, his red and white 96 two-stroke driving in, all eyes would follow to their parking spot. Of course, they may have driven a round-about 1,500 miles to get there, and 500 miles of that on Friday. And after all that driving, another hour or so would be spent in the parking lot, talking to everyone, before heading off to the room.

About a year and a half ago, Autoweek magazine did an "Escape Road" article featuring our 96. Larry tore the page out of his copy and mailed it to us before I even had a chance to see it myself. That page has been framed and hung in our Saab gallery ever since.

Coming back from Stratton '94, I had a problem with the 96 this side of Albany, but still 50 miles from home. Fifteen minutes later, Larry, with co-pilot Eric Johnson, pulled over behind me on the side of I-88. Larry decided that it was a fuel problem, hooked up one of his spare electric fuel pumps, and we were off, then following me home. In our driveway, Larry found that the little known fuel filter inside of the carburetor no longer did. The car ran better than ever with that problem sorted. Before they left that evening, I took a picture of the two of them and Sadie in our driveway. I always liked that picture, because it really was an honor to have them in our driveway.

Perhaps I best remember Larry through our son, Riley. The first Saab event that Riley went to was Stratton '94, age 1 1/2. At Lake Placid '96, Riley, at age 3 1/2, noticed that Sadie had a different color hood and new Sonett wheels.

At age 2 1/2, at Bruce Turk's summer picnic, Riley had his first bubble gum, from you know who.

This past fall I found some small, inexpensive, red short-nosed 96 plastic cars. For fun one night, I painted one up like Sadie for Riley. When he plays with his cars, he often plays "Saab convention," where he lines up his Matchbox 9000's and Sonett, his Minichamps 900, and his Eko 96's. The Saabs are exactly that. 9000's, Sonetts, 900's, 96's, etc. But that red and white 96 is always Larry Williams.

I, like many others in all of Larry's interests, have many great memories. He lived in Iowa, we in New York State. We saw each other at conventions, all six of them, three days at a pop, for about a total of 18 days. Larry could leave quite an impression on all of us.

**Ed, Cameron, and Riley Lorenz**  
Oneonta NY

Larry Williams was my friend. One cannot be more privileged than that! As anyone who knew Larry more than five minutes, I can recall many many stories, however, three incidents stand out.

Ruth and I first met Larry and Katha at the Saab convention in Chambersburg in 1985. They immediately made us feel welcome and made our first convention one we shall never forget.

Four years later, at the Saab convention in Las Vegas, Larry and Katha asked Ruth and me to join them, one evening, in a trip to downtown Las Vegas. All four of us piled into "Sadie" which under normal circumstances would be no problem. However, as those who knew Larry understand, normal circumstances were rare with Larry. He had removed the front passenger seat and

replaced it with a complete spare engine, "just in case." That meant Katha, Ruth and I became very good friends in Sadie's back seat. On the way downtown we were stopped at a traffic light when I saw a man walking over to Sadie. I told Larry to rev the engine up and down while worked the throttle linkage on the spare engine. When the man stuck his head in the window and asked what kind of car this was, we told him it was a mid-engine car and with that I pulled back on the linkage and Larry pulled away from the light. We left that poor fellow standing there with his mouth open.

The last time I saw Larry was at 7:05 am Monday, October 13, 1997 outside Dan's Repair in Victor, Iowa. I had bought a 1970 model 95, sight unseen, from Smart Motors in Santa Fe, New Mexico two days earlier, and had broken down on Interstate 80 (points broke) and been towed into Victor, Iowa the night before. That night it rained about 4 inches and the temperature dropped into the upper thirties as I slept in the drivers seat. I woke up in the morning to see Larry grinning though the window while holding up a cup of coffee and a donut which he thought I would need.

I miss Larry.

**Al Sutton**  
Barrington, IL

I would like to thank you as editor of NINES for the two page tribute to Larry in the #237 issue. The picture on the back showing him in Sadie at the New Hampshire race track was a beautiful touch and one I know would have touched Larry.

We have heard from so many people from all over our country, and a few from Canada and the United Kingdom with flowers, cards, pictures, letters, phone calls, and e-mail. Their kind words about Larry have meant so much to both Frank and me. Larry had a special love for old Saabs and for the people who loved and cared for them.

It was a very difficult decision to decide to sell Larry's cars, but he often told me these cars were meant to be driven, not to be stuck in museums or garages to rot. He was very passionate about this; probably why he drove his own cars instead of towing them to Saab get-togethers. So, amid many tears, the decision was made. Marty Adams of Meyer Garage and Eric Johnson were so helpful during this difficult process. All of Larry's cars were bought by people who will care for them well. Tom Donney bought the 1950 92 and the Getaway Car, a black 1961 96; Eric Johnson bought the beige 1964 95 named Mouse; Charlie Green bought Sassy, the 1967 Sonett; and Greg LeBaron bought our favorite, Sadie, a 1962 96. Larry's brother Pete has Larry's tow car, Ole Blue, a 1978 99, and will finish restoring (saving) the 1957 93 Larry bought last fall in Ohio.

Time is drawing near for the annual Saab Convention. I can only imagine instead of really seeing him in the parking lot among many old Saabs conversing about new methods of saving two strokes with his friends. He so looked forward to dispensing his knowledge and learning from all the fellows and an occasional lady who shared his fascination with these unique automobiles. Old Saabers are like a special fraternity but instead of a party, they look forward to the events where they can admire each others' cars, tell Saab stories (mostly stretched), share ideas, sell, trade, give away and swap parts.

I think the idea of the traveling trophy in Larry's memory is a great one. I gave Eric a radiator that Larry had polished and a 96 model car to use as part of the trophy. I am anxious to see a picture of it when finished. The final creation will be an original, just like Larry.

Happy Saabing,

**Katha Williams**  
Waterloo IA





New and Used SAAB Parts  
VISA/MASTERCARD ACCEPTED  
TOLL FREE ORDER LINE

**1-800-882-7220**

Info: 612-389-3805 Fax#: 612-389-3875  
3558 Brickton Road, Princeton, MN 55371  
www.andrewsofprinceton.com  
E-mail: chuck@andrewsofprinceton.com

The Midwest's Largest Selection  
of Previously-Enjoyed Saabs.  
Over 20 in stock.

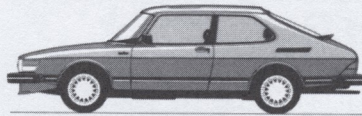

**Tom Donney Motors**

Fort Dodge, Iowa

**800-626-SAAB**

Iowa's Independent Saab

Sales Service Parts

**Celedinas' Power Plus**

Rocker Arm Assemblies  
for the Saab V4  
Reduced friction and binding means  
a higher revving engine.

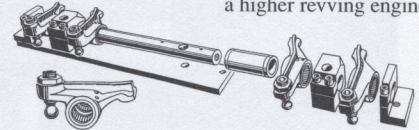

George Celedinas  
14 Cassilis Road

West Hartford, CT 06107

**860-521-1649**

### Even the small tips help

I, for one, would like to commend you, Tim, on the Nines publication. I look at some of the older issues and can see the refinement that has taken place. There may be some issues that I like better but that's more of a personal choice and if you "just wait" your favorite subject will be printed. For those who like to be critical... they need to put together an article on their favorite topic and send it to you. I'm sure you wouldn't object!

**Jim Iverson**  
Cedar Rapids, IA

I would like to put in my vote for a story on Barry Jerome's conversion of his '78 99 as mentioned in his letter in Nines #237. I have a '78 and would like to someday do something similar so I would love to hear what he has to say.

Over the years, I have made a number of "fixes" on my 99 and I would be willing to write them up and send in a few pictures and/or sketches if there is an interest in work on these older Saabs. I have made a repair on my odometer that has lasted 200k miles now so I think it was a good fix. I have also repaired the inside door handle when the "pot metal" broke and that seems to be working well too. My fix on the turn signal when it failed to stay on only seemed to last about 4 years, but it might be worth mentioning. I also moved the battery to the trunk about 4 years ago when I put in a turbo engine and that has worked pretty well (it is our of sight, hasn't failed to start the car and hasn't fallen out on the road).

I'll try to find some time this summer to write one of these up and send it in. The Saab club publication has changed over the years, but I still enjoy it and read it cover to cover. Keep up the good work.

**Jesse Strack**  
Wellington, CO

### I Believed a Myth

Back when I owned my first Saab, a 1985 900T, I was young, stupid and believed everything I read. Somewhere in the 1985 Saab Sales Brochure it is written, and clarified with a drawing, that their Saab 900 driveline and front suspension are "built to rally specs." This meant two things to me, go fast and go anywhere. Sure I drove that car hard, real hard, over roads today's SUVs wouldn't dare tread and yes even through a small bog, or was it a fen. Eventually the car died from the abuse so I bought another turbo and destroyed it. You see every time I pulled into the Saab repair facility and dropped bucks on my 900s it felt to me that I was just being a rally pro in between stages. The only difference was I picked up the tab not Mr. Sponsor. I must have changed CV joints yearly as well as wheel bearings

and parts too long to list for the fear of boring you. My last Saab made it to the Arctic Circle and waited till 200 miles above that to break. My point is simple, trash anything and it will break, even a car built to "Rally Specs."

**David Cracchiolo**  
Grosse Pointe, MI

### 900 Wiper Failures?

Every day I drive my 1985 900T (3-dr; 153K mi.) and on weekends get out in my 1972 Sonett III (yes, it's a green one but it's in beautiful condition). You may not be able to tell from the following message, but I really do have a thing for SAAB's. These are safety issues that SAAB should address, and that other owners should be alerted to (not just those who read Nines and/or the various Internet news groups).

I'm very glad that the new issue contains an article on cracked A-arms (by which I presume you mean the lower control arm in the front suspension). Mine recently had to be replaced and it was disturbing to me that such a serious safety problem existed on my car. When I mentioned it on some of the Internet mail groups, others chimed in they were already well aware of this old problem that they said afflicted our beloved cars over several generations. Why wasn't such a serious design flaw recognized and corrected sooner? Anyhow, I look forward to seeing that article.

Just two days ago here we had a serious rain storm and I was driving on the freeway. Suddenly, my driver-side wiper stopped working! This was at ~55 mph in traffic and in heavy rain on the freeway - yikes. The passenger side wiper still was working so I knew it wasn't the motor but some part of the linkage that had failed. This was small comfort, to have diagnosed the problem while wondering whether or not I'd be able to see out by the time I got to the off-ramp. Well, I safely made it to work, and later was able to get inside and see what had gone wrong. No surprise, the wiper rod that connects through the gasket had worked its way off of the bushing that spools back and forth. I would never before have really thought of my windshield wipers as being a crucial safety item on my cars until this incident occurred.

Even though I normally feel very safe driving in my 900T, these two problems make me wonder. There's certainly room for improvement, and I presume a lot has been done since the 1985 model year. But some of us are still getting a few more miles out of the older cars, and our safety, the safety of our passengers, and the safety of other drivers around us on the road, all count too.

Sorry to rant and rave, but this thing with the wiper the other day was bad. I hope it was just a rare fault that not too many others have experienced or ever will experience.

**Ken Hudnut**  
via email



# Notes in the Margin

by Stephen Goldberger

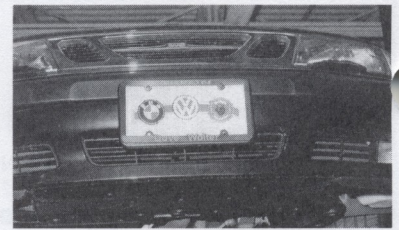

Figure 1: Our benefactor, Dave Walter Saab

## Getting it Right

In Nines issue #236, I made a comment extolling the properties of variable displacement air conditioning compressors, said comment having moldered in my computer since the spring of 1996 awaiting space in my column. The following excerpt is from the Saab USA web-site, dated January, 1998, and refers to the 9-5:

"New Variable Displacement AC Compressor

"The air conditioning compressor is a new piston-type, variable-stroke design that can vary the quantity of refrigerant it pumps through the system, to suit the temperature reduction required. It uses less energy than a conventional vane-type compressor, but provides 28 percent more cooling effect. This reduces the time required to cool the interior after standing in hot sunlight by up to 50 percent."

I certainly am not above crowing about the rare instances when I get it right. Continuing with the news release:

"...A shut-off valve now isolates the heater matrix from the engine coolant, to improve the effectiveness of the cabin cooling."

Lets hope they have better luck with this one than they've had on the 900s and 99s.

## Getting it Wrong

Sharp-eyed readers of NINES may have noticed an error in the table showing filter types versus filtering area. The PF20, an AC/Delco filter of equivalent size to the FRAM PH43 as shown in the photographs and described (but not named) in the text, was erroneously listed as a "PF47" in the table.

PF47 is a size which fits the Infamous Citation and other GM cars. It will definitely not work on a Saab, although the author will frequently work on a Citation.

An even-more-sharp-eyed reader noted that the AC/Delco PF13, a size equivalent to the Fram PH16 (and the MANN W920/26), is made in England, as is the well regarded, small Delco PF53. Had I been aware that it was English, I certainly would have included it in the study, given the good showing of it's smaller brandmate. Visual inspection indicates that the PF13 is constructed similarly to the PF53, and thus it would be a good choice for those who use the larger sized filter.

## Getting Down (and Under)

As has been my custom for every all-new Saab model since the 9000, I have exploited the good nature and frame-hoist of Dave Walter Saab, in Akron, Ohio, to photograph the suspension and chassis for analysis and comment. So, for the second time in the millennium: presenting Saab's latest underside!

### Front Suspension and Subframe

As shown in Figures 2 through 7, the front arrangement is conceptually a continuation of the current 9000, but with some notable differences in execution. The subframe is completely different, made from rectangular cross-section stamping, elaborately contoured and forming an open "C" shape as compared to the "box" 9000 frame. The "open end", however, is tied together by an assembly of plates in a manner far to intricate to have been derived from a whim: this detail must do something important. The subframe

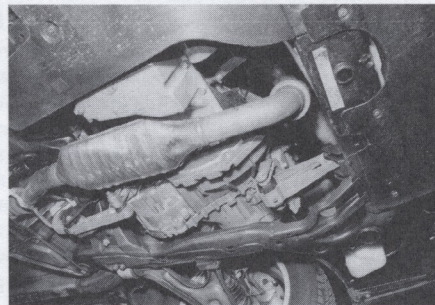

Figure 2: Front Subframe

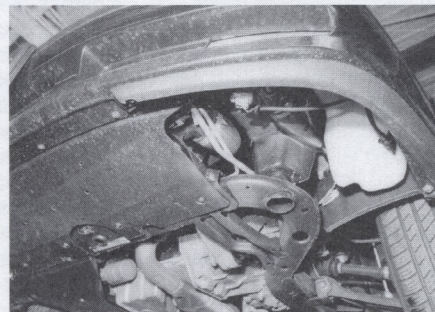

Figure 3: Front Subframe. Note frame to body mount, suspension pivot mounted to frame side, and fog lamp connector.

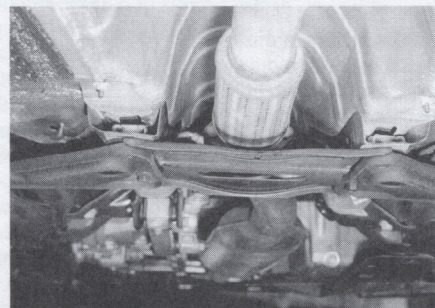

Figure 4: Plates tying together subframe ends, and body attachment.

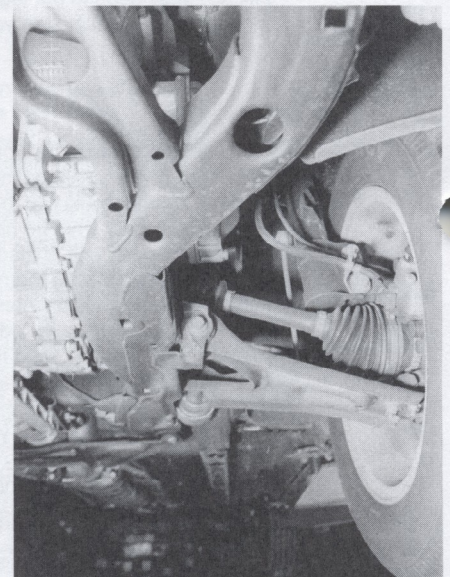

Figure 5: Front suspension and subframe detail. Note floorpan, longitudinal stiffener, and recessed exhaust

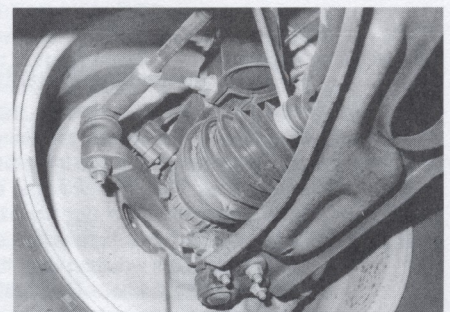

Figure 6: Front suspension. Note single piece, pressed lower A-arm, ball joint, ABS sensor and "tone wheel", tie rod end, strut mounting pinch bolts.



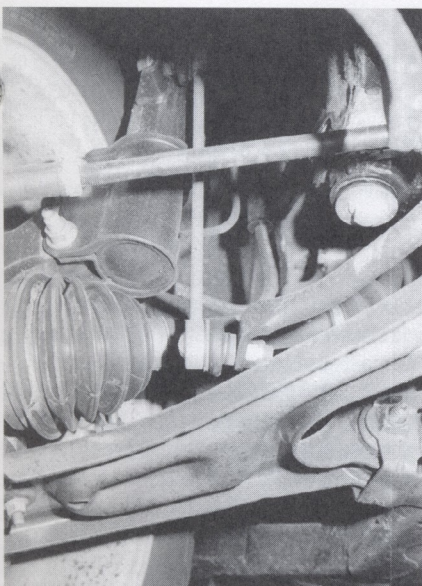

Figure 7: Detail of front roll bar attachment. Note slender rod, spherical bushing, and attachment to strut body.

is no longer galvanized, it is not "hinged" for removing the transmission from below, and is more integrated structurally with the body for crash resistance. The lower suspension arms (fig. 5) are single piece, heavy gauge stampings, rather than the two-piece built-up 9000 parts, and are no longer galvanized. The anti-roll bar is attached (fig. 7) through slender rods to the strut tube, rather than being attached to the control arms, by means of precise spherical bushings (tie-rod ends). Fig. 6 shows Saab's traditional, bolted-in ball joint, rather than the integral ball-joint-suspension-arm or riveted in joints favored by some makers.

I suspect that the suspension arms and strut housings are standard-issue "Vectra" parts. The absent hinge in the subframe is not an issue, since most manufacturers of transverse-front-drive cars specify transmission removal through the top, rather than underneath. The move away from galvanized is a disappointment for us in the salt-belt, but hopefully the finish will prove to be capable of withstanding the elements. The sway-bar attachment is notable in its precision. Hopefully the spherical bushings will not prove troublesome, as replacing one means replacing the entire link.

### Rear Suspension and Subframe

Fig. 8-11 show details of the rear suspension. This is said to be based on the current Opel Vectra design, and it is unlike any other I have seen in the USA. It will be interesting to compare the Saab interpretation with the one on the upcoming Saturn model, which is also said to be derived from the Vectra.

To begin with, this new independent suspension is definitely not a "strut" design, as some reviews

**WORLD'S QUICKEST**

# RED LINE OIL

- Gain up to 10 Horsepower
- Run up to 20° Cooler
- Reduce Wear

• Race Oils • Gear Oils • Motor Oils • MTL  
• ATFs • Lubricants • SuperCool Water Wetter

CALL TODAY FOR THE DEALER NEAREST YOU  
ASK FOR YOUR FREE CATALOG AND TECHNICAL INFO

## 800-624-7958

FAX 707-745-3214  
6100 EGRET COURT, BENICIA, CA 94510  
VISIT RED LINE OIL ON THE INTERNET  
[www.redlineoil.com](http://www.redlineoil.com)

in the popular press claim. Fig. 11 shows the lower shock mount, which is pinned (engineering term) to the rear hub assembly. While the lower spring mount is welded to the shock body, this does not make it a strut.

Fig. 8-9 show much of the trailing arm/hub assembly, which is a single, stout iron casting. The pivot, fig. 8, is recessed into the bodywork, eliminating the need for Saab's trademark mid-body flaps which protect the pivot on the 900's and 9-3, or the more stylish plastic housing which serves the same purpose on the 9000. The pivot is almost on the same level as the axle centerline, and therefore a second longitudinal link to control axle "windup" during braking is not necessary. Two heavy gauge, deep section lateral members per side complete the suspension geometry. These pivot on a pair of steel subframes which tie to the body through 4 widely spaced rubber mounts. The upper lateral arm is deeply contoured to allow long suspension travel without bumping the bodywork.

The Saab/Vectra suspension is economical in its use of parts, exhibiting good control over the rear wheel geometry with just three links and without resorting to a costly rear strut. It accomplishes this, where other companies use up to 5 links, through a combination of clever design and the use of stout members capable of controlling motion in more than one dimension.

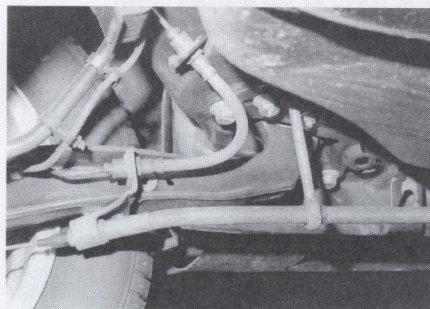

Figure 8: Rear suspension trailing arm/hub. Note recessed pivot, emergency brake cable, hydraulic flex hose, and cable for ABS sensor.

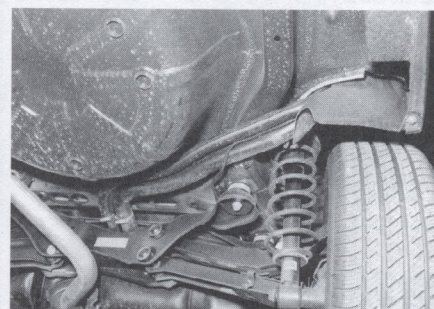

Figure 10: Rear suspension. Note upper and lower lateral arms, rear subframe mounting pad, rear shock and spring, and rear inner fender.

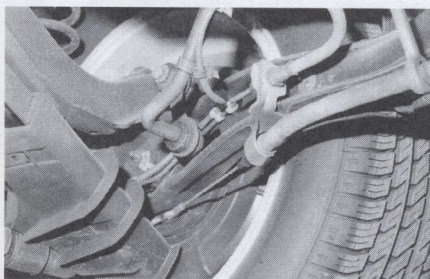

Figure 9: Rear suspension trailing arm/hub. Note heavy gauge, ribbed plastic guard and lower lateral arm, heavily contoured upper lateral arm, and that the rear hub and trailing arm are a single cast iron piece.

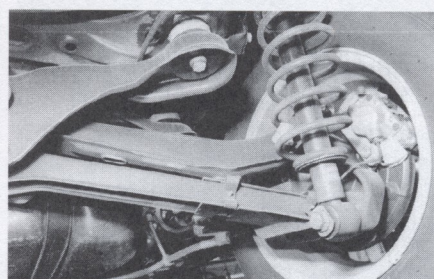

Figure 11: Rear suspension. Note mounting of rear shock, spring seat attached to shock body, and traditional ATE opposed piston rear brake caliper.



## SPORTS CAR SERVICE

Home of Sonett I No. 6

Visit our website at  
<http://www.sportscarservice.com/>

*See you at the Convention!*

### ZYMÖL

PURE, POWERFUL, PERFECT

Saab Wax \$35.00

HD-Cleanse (Pre-wax treatment)  
8.5 oz. \$15.00

Clear Auto Bathe 8.5 oz. \$15.00

Treat for Leather 8.5 oz. \$25.00

Vinyl Treatment 5 oz. \$15.00

Strik Oil & Grease Remover \$25.00

Detail Aerodynamics Wax 2 oz. \$15.00

Our DIN-spec *cup/coin holder* replaces the ashtray and cigarette lighter in your 9000 and looks built in. \$56.00  
Our black porcelain *travel mug* with SAAB in 22 ct. gold fits it perfectly! \$14.00

### Dash Designs

Cracked dash? Faded rear deck?

Dash covers for 900 or 9000 Black only  
\$36.95

Rear deck covers for 900 hatchback \$39.95  
Specify interior color, model and year.

### HeatShield

Advanced Window Reflector

Custom fit for your Saab

Cools interiors up to 40°F

Prevents dashboard cracks

\$29.95

### Enameled Metal Grill Badges

SAAB SCANIA, Swedish flag,  
other countries and marques available

\$17.00

### Comfy

Sheepskin seatcovers to match your interior.

*A masterpiece of affordable luxury.*

\$175.00 per seat Shipping wt. 4lb.

### THULE

Car Rack Systems

10% off list. Write for brochure.

Shipping: 5lbs & under \$5. Over 5lbs \$10

Order by fax: 302-764-7454

Mail: 3901 N. Market St.

Wilmington, DE 19802

c-mail: [scboutique@aol.com](mailto:scboutique@aol.com)

## Exhausting Analysis

Fig. 4 and 12-15 show the exhaust system. As seen in fig. 13, the exhaust flange joint which has proven to be reliable and effective in the 9000 is carried into the 9-5 exhaust. The entire exhaust is made in just two pieces. The headpipe, catalytic converter, and two flex joints are made as a single piece, as are the front and rear muffler and connecting pipe. Installing an aftermarket catalytic converter in this baby will be a real challenge. I couldn't tell whether the exhaust is all stainless, but there wasn't a noticeable difference between the shine of the catalytic converter and the rest of the parts.

## Details, Details, Details.

Fig. 14-15 show the exhaust routing under the fuel tank. Unless there is some plumbing inside the tank, drivers low on fuel will learn the "brake hard turn left" maneuver to slosh fuel over the hump. Fig. 16-18 show interesting torque-links to the transmission. Fig. 3 and 19, of the front underbody trim, show a heavy plastic shield under the center 2/3 of the underside, and a covering extending back behind the engine to enclose the belt-driven accessories. Not covered are the corners. They really could use some shielding, because the fog/turning lamp connector (Fig. 3 & 20) hangs precariously close to the lower edge of the air dam. The subframe to body mount (fig. 3) is made by piercing the subframe with a large diameter tube, welded to the mount and bolted up to the body. This stout joint forms part of the crash structure, allowing the subframe to share in dissipating crash energy.

Fig. 21 shows Saab's trademark recessed rocker panels, with their stylishly shaped cladding. Cladding also

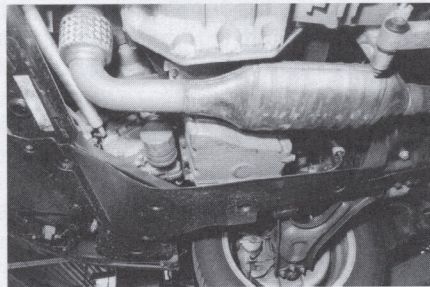

Figure 12: Front underbody. Note unified head pipe, flex joint, and catalytic converter. Note also plastic guard for belt and belt-driven accessories, and horizontal Saab labeled AC PF53 oil filter.

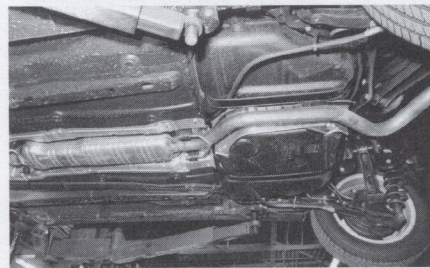

Figure 13: Exhaust detail. Note flex joint, integral with the catalytic converter, flange joint, and front muffler. Also note fuel and brake hoses, and heat shield mounting detail.

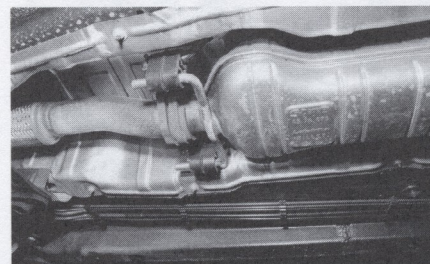

Figure 14: Exhaust routing. Note tunnel molded into fuel tank, absence of joints in connector pipe, and another view of rear suspension. Wide angle lens distorts rear suspension geometry.

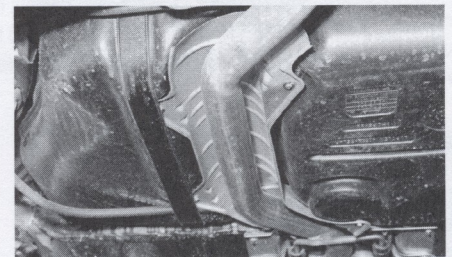

Figure 15: Exhaust detail. Note exhaust tunnel molded into fuel tank, depression for fuel pump on right side of exhaust tunnel.

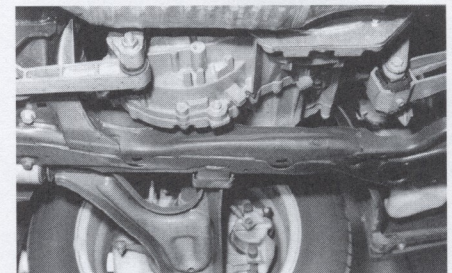

Figure 16: "Torque rods" attached to transmission.

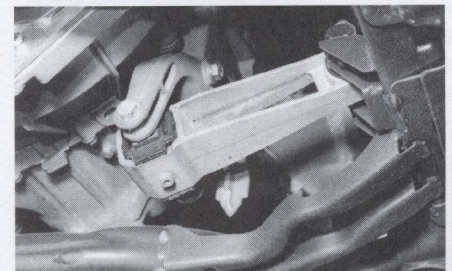

Figure 17: Rear torque rod. Also note subframe details.

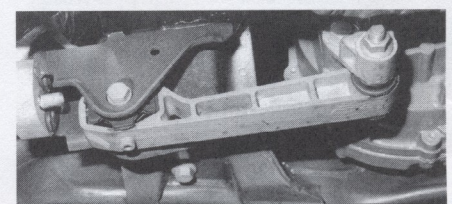

Figure 18: Front torque rod.



covers the lower lip of the door where gravel can do damage to the paint and allow rust to start. There are also heavy plastic guards attached to the hub-end of the lower rear suspension arms (fig. 9), protecting it's mount to the hub and the shock absorber lower mount. Fig. 10 shows the rear plastic fender liner which acts like a very short mud flap.

Fig. 22 shows the simplified mounting of exhaust shields to the body, with screws penetrating down through the floorpan and the shields held on with pressed-metal nuts. The 9000 shields were mounted close to the center, above the exhaust, with studs permanently attached to the shields penetrating the floor pan and bolted from inside the cabin. The new way is vastly superior when replacing shields which inevitably corrode in areas where salt is extensively used.

The floorpan (fig. 23) from the firewall back to the fuel tank is completely flat with longitudinal stiffeners, except for the exhaust tunnel. The fuel tank bottom continues the line of the lower body and shields the rear suspension from the air flow. The spare tire well and rear bumper pick up the line as best they can, but still the underbody is about as smooth as a production vehicle can be. Fuel and brake lines are tidily placed along side a longitudinal stiffener for protection (fig. 24).

About the only carryover part from the 9000 in the underbody is the plastic guard over the fuel filter (fig. 25). I'll assume this means that the same fuel filter is also used: good news because of the stack of fuel filters in my basement!

Having spent plenty of time beneath past Saabs (entirely too much time, according to Mrs. Goldberger), I believe the 9-5 follows in the tradition of stout and straightforward design. Consideration of those unpaved Swedish roads shows in the protection given to critical components and the lower bodywork and in the heft of the suspension components.

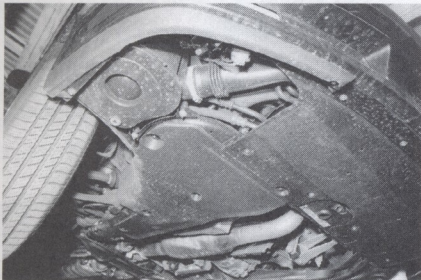

Figure 19. Front underbody detail. Note central underbody shield, large shield protecting drive belt and belt-driven accessories. Air filter housing is on right side. Also note subframe detail, rear.

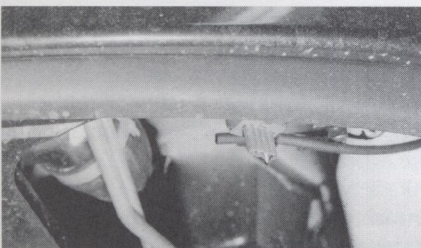

Figure 20: Exposed fog light connector. Camera angle makes it look worse than it is, but in reality it's bad enough.



Figure 21: Recessed lower door sill, plastic cladding, and cladding on door bottom edge.

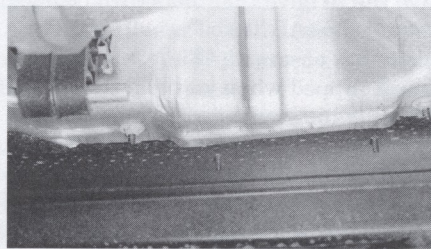

Figure 22: Detail of heat shield mount. Stainless steel press-metal nuts, easily accessible for replacement of shields as needed.



Figure 23: Flat floor pan from fuel tank to firewall, with longitudinal stiffener.

All Recycled Saab Parts  
93B, 95, 96, 99, 900, 9000



East West Auto Parts Inc.  
4605 Dawson Road  
Tulsa, OK 74115-4102

800-447-2886

or 918-832-7077

**J&B Imports**

**Saab & Volvo  
Service and Repair  
(714) 282-7378**

*Factory-trained technicians  
with over 45 years  
combined experience*

Specializing in:

- All years
- All models
- Turbo repairs
- Turbo performance
- Two-stroke engine repair

Fax #: 714-282-0457

2296-A North Batavia  
Orange, California 92665

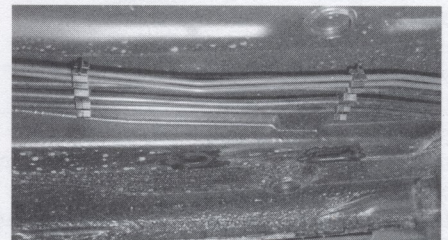

Figure 24: Detail of brake line and fuel h mounting.

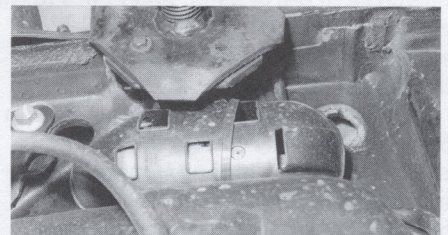

Figure 25: Fuel filter and filter guard carried over from the 9000.



# Discourses & Digressions

by Bob Sinclair

Bob Sinclair was the president and CEO of Saab-Scania of America from 1979 to 1991. He was credited with increasing Saab sales in the U.S. during 1980s, and known for his flamboyant style. Though he has retired, he remains quite busy... and opinionated.

[A compilation of posts to Turbo! wherein Bob Sinclair expounds on the vagaries of the world and the marketing of our beloved Saabs. Compiled, with commentary by Paul Galanti.]

## Special Black

A C900 Turbo owner wondered about his "Special Black" paint that was stickered at \$400. What was so special about "special black" and why did it cost so much extra?

[Now whatever color Saab a NINES reader drives, we all probably understand that there is something "special" about a black Saab Turbo. So much so that Douglas Adams, author of the five-volume "Hitchhiker's Guide to the Galaxy" trilogy - and the driver of a black C900 Turbo when he lived in the US - is quoted in Neil Gaiman's "Don't Panic - The Official Hitchhiker's Guide to the Galaxy Companion" as describing Marvin the Paranoid Android as being not silver but the "colour of a black Saab Turbo." g.]



So Bob gave us a little education on "marketing 101:"

There's a story (it seems there's always a story) about "Special Black" paint. Special Black was introduced by yours truly as a replacement for "black:" the reason being that in my opinion the percentage of black cars in our model mix was getting far too high; too risky in case for some unknown reason buyer tastes suddenly shifted. So to gently put the brakes on demand, we introduced "Special Black"; in other words, an upcharge to the dealers, and hence to the car buyers, for black. Sales slowed somewhat, but the share of total taken by black remained quite high.

The next step was a proposal from Sweden that they charge the U. S. importer ("my" company) a premium for black cars. Their argument was that black allegedly took greater care (more time) on the paint line due to the risk of dust specs in the paint, blah, blah, blah.

Naturally I stonewalled them, mainly because it was fun to watch the export guys writhing as they saw us enjoying a windfall that they couldn't get their hands on. The incremental revenue, of course, was consolidated into our total bottom line. It eventually went to Sweden in the form of additional dividend income, but not to the export division who received payment for goods shipped across the ocean.

## Debadging

According to one Turbolite "The only year Uncle Bob got his wish..." to have the to have the C900 Turbo badged just as a "SAAB Turbo" was 1984. The subscriber observed; "They must have almost flipped when you told them you did not want any badges on the SPG!" [The 900 SPG, introduced as a 1985 model, had only the Saab-Scania roundels on the hood and the left side of the hatch with SAAB.]

To which Bob responded:

Thanks for the compliments. And yes, they sure were appalled when I argued for deleting the badges. I wanted ALL of them deleted, except for "Turbo" (which as I recall is cast into the grille anyway; at least I wanted to keep that, and only that).

I continued arguing just as strongly, knowing full well that this would add an extra panache to the black Turbos which had become a really hot item in some circles. One of my good friends in Los Angeles drove one. One day he phoned me in Connecticut to report that the night before he had been to the Palm Restaurant (a high-zoot L.A. watering hole at the time) and the parking valet had parked his black 900 Turbo right out front... along with the Ferraris, Rolls-Royces, and the like! That was a very pleasant day for me, let me tell you.

I got my way with the badge delete request, eventually. Mainly, I think, because I pointed out to the president of the Car Division all the money they could save. Those badges do cost money, after all! They finally, after a lot of back and forth, agreed to deleting all but

"Turbo," and of course, SAAB.

But the next move by the export office nailed me. They came back with an upcharge for leaving the badges off! They claimed it disrupted orderly production, that the people responsible for applying badges had nothing to do when the black Turbos came down the line, etc.

I still think they were wrong. Can you imagine what the journalists would have done with a company having the ... [Ah, er. The testicular courage? g.] to bring a car to market without its brand name on it?

It would have been just marvelous! Oh well, you can't win 'em all.

Car Biz, like life in general, can be a lot of fun if you don't take yourself too seriously.

[But no one ever thanked Bob for coming up with the cost saving idea in the first place! g.]

## Refrigerated Glove Boxes

Then someone commented on "refrigerated glove boxes" (a feature on the new Saab 9-5). The glove compartment can be used as a fridge with the help of the AC (+6 degrees Celsius).

[The Maven commented: THAT RULES!!! My youngest son would have that thing STUFFED constantly...11 years old, skinny and eats like a horse. Can't wait until he's a teen ...dooh! He didn't want to go to a Professional Rally the other day until I told him he could take a backpack full of food along to munch on while out in the woods. The state trooper that inspected our bags when entering the spectator area commented, "Wow, that's a lot of food! How long do you plan to stay?!"]

Bob commented: For whatever it's worth, I argued *very* hard in favor of plumbing the new 900's air conditioning system so you could route the cold air through the glove box when desired. When I first brought it up, the Swedes at the design center looked at me like I was nuts; then a few of them scratched their heads and said that just might have some value. But it never made it to the list, which I thought was a shame. It



would have provided a talking point in dealer showrooms at extremely low cost... even if relatively few people really want or need a refrigerator in the passenger compartment.

Apparently the idea wasn't forgotten, and that pleases me a lot. Only took almost two decades to see the light of day. We don't want to rush things, boys and girls.

[Galanti expressed surprise that "the lawyers" approved: Some glove boxes are just that (only if the gloves are small) but others are just about six-pack size. And there might be a lawyer somewhere who would sue Saab saying his client wouldn't have been driving under the influence if Saab hadn't made it so easy.]

So Bob gave us some thoughts on imbibing/responsibility/ and the legal profession:

Yes, I wondered if the corporate "ombudsmen" would approve it when I suggested routing cold air through the glove box of the New Generation 900. But I thought it was a good idea from the marketing perspective, and still do. [And we NG900 drivers wouldn't let anyone forget about it! g.]

RE *why* they approved it, I have no idea. As I've posted a number of times, the car biz is a lot more complex than it appears on the surface.

Unfortunately it often comes down to weighing the risks of lawsuits (and the likely cost of same) against bringing something with strong sales appeal to market. And of course, *this* varies tremendously depending on the jurisdiction.

I was in New Zealand recently, circumnavigating the north island by motorcycle. I was struck by many, many items of daily living which have potential for personal harm that are quite different from here in the Land of the Free, Home of the Brave.

Item: Every town park and every school yard I saw was equipped like they used to be here in this country: swings (some with wooden seats, but most with some kind of textile "sling"), monkey bars, see-saws, sliding boards with about a 12" drop to the ground at the bottom, merry-go-rounds, etc.

Item: I saw lots of crosswalks on busy roads with short lengths of fences on each side of the road, fitted with gates that people crossing the streets were expected to open and then latch closed behind them. I saw small children waiting behind the closed gates until the

road was clear, then opening the gate to cross the road and carefully latching it behind them.

Item: Traveling on mountain roads (main roads, as to go from one major location to another in that country, there usually is only one way to get there ... on the main road) I was struck by the fact that there were *no* armco barriers or even curbs to keep one from driving off the side of the mountain. In the really dangerous spots, there usually were wooden stakes around 3 feet high marking the edge of the road, but barriers? None. [Hey, Sicilians do that one better: The mountain roads near Mount Vesuvius have (or had 30 years ago) spring loaded cones at the edge of the roadway. So if you went off and were plummeting through space at least the cones would spring back to warn the next driver. g.)

Item: The windows on upper floors of hotels we stayed in generally would open quite wide, unlike those in the U. S. That, probably for liability reasons, open just a small distance so people can't climb out of them.

These are but a very few examples. After a few days I asked my New Zealand relatives (traveling with us, one by motorcycle and the other in our Land Rover support vehicle) about liability laws and such. They looked at me with great amusement. "Where ya think you are, in the Stights? People don't sue in this country if they get hurt because of their own damned foolishness!" (They speak a rather colorful language down in the Antipodes ... at least my relatives do).

How does this bear on putting fridges in the glove box of Saabs? I really don't know, but it could have a lot to do with the fact that in Sweden people *do not* drink and drive. Not one whiskey; not a single beer. Get caught and you *do* lose your license, and you *do* go to jail. It simply isn't done, and after many years the main motivator (at least in the upper levels of society) has little to do with the penalties involved.

It is totally unacceptable socially, for example, to have wine with one's meal when a guest in someone's home and then drive home afterwards.

I have posted some stuff about the decline in "civility" in U.S. society. I look on our current litigiousness (if that's a good word) as part of the whole package. In New Zealand, people are expected to

# Nokian Hakkapeliitta

Made in Finland!!!

## The World's Best Winter Tire

The ONLY winter tire with it all:

- Unbeatable traction on snow or ice
- Quiet and stable on dry pavement
- Very long wear



Hakkapeliitta 1

Most sizes studdable with  
Revolutionary New Advanced Stud



Hakkapeliitta  
NRW

**ON SALE THROUGH  
SEPTEMBER 30.  
10% OFF WHEN YOU  
MENTION THIS AD.**

Available mounted & balanced  
on OEM style steel wheels.

**GREER ENTERPRISES, Inc.**



**414-545-2296**



Milwaukee, WI

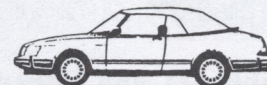

## SAAB CONVERTIBLE TOP PARTS

Top Cylinder  
\$120

Motor Pump  
\$199

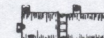

Hold down tension cables, 87-94 ..... \$29.95/pr

### 1987-94 Stayfast Canvas Tops

with heated glass window ..... \$599

1987-94 Headliner, black ..... \$149

### 1995 Stayfast Canvas Tops,

w/heated glass ..... \$1150

### 1996-98 Stayfast Canvas Tops,

w/o glass ..... \$1000

### 1996-98 Original type Sonnenland

cloth, w/o glass ..... \$1250

Glass (customer installed) ..... \$195

### Car covers, universal fit

Indoor/light weather ..... \$47.95

Moderate weather ..... \$73.95

Evolution 4, all season coverage .. \$129.95

## HYDRO-E-LECTRIC

48 Appleton Road, Auburn MA 01501

**Call Toll-free 800-343-4261**

Info: 508-832-3081 Fax: 508-832-7929

*America's Convertible Headquarters*

**cont. to page 28**



# Parts and Service Information

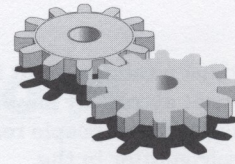

## Installing On-Off Switches or Disconnecting Airbags

*Technical Service Broadcast - 2/5/98*

Recently the National Highway Traffic Safety Administration (NHTSA) sent a packet to all new car dealers, containing information regarding the installation of retrofit air bag on-off switches. Also included in the packet is a number of NHTSA brochures that are packed with information regarding air bag and seat belt usage, operation, as well as information about on-off switches. We would like to pass along the information we have regarding Saab Cars' plan and schedule to make switches available.

Our Factory is committed to producing on-off switches kits for our airbag systems. The following TARGET dates for availability have been submitted to NHTSA from Saab Cars:

1994-98 9000	Models	7/98
1994-98 900	Models	7/98
1995-98 900	Convertible	7/98
1989-93 9000	Models	12/98
1990-93 900	Models	12/98
1990-94 900	Convertible	12/98

Until the switch kits are available the only alternative the customer has is to request temporary disconnection of the air bag. This must be done by the owner contacting NHTSA directly at 1-800-424-9393. Approval will be granted in a case by case basis. If the owner fits the criteria for NHTSA to allow disconnec-

tion of the air bag, the owner will be sent a set of instructions in the form of an SI with the part numbers and the procedure. The customer will then contact the dealer to perform the disconnection and/or order the parts kit. The NHTSA approval does not bind the dealer to perform the procedure and the dealer still has the option.

*Saab would like to emphasize the following:*

1. All Saab cars have a rear seat that will accommodate infant and child restraints—occupants 12 years and under should be seated in the rear—and that except for the convertible model, there is room for up to three rear seat occupants.

2. Any occupant in the front passenger seat can be protected from serious air bag deployment injury by moving the seat to its full rearward position, properly wearing the lap/shoulder safety belt, and not leaning forward.

3. Maintaining a 10" distance between the driver and the air bag is possible even for short-statured drivers by:

- moving the seat itself a far back as possible while still being able to operate the pedals
- slightly reclining the seat back
- and installing pedal extensions if necessary.

4. Should questions still be unanswered:

- Read the NHTSA brochure
- Check out the NHTSA web site at [www.nhtsa.dot.gov](http://www.nhtsa.dot.gov)
- Call our Customer Assistance Center 1-800-955-9007
- Contact NHTSA Hot Line at 1-800-424-9393

## Availability of Child Tether Anchorages

*Background*

Saab Cars USA, Inc. has available retrofit top tether anchorage kits for back seat positions in most 1989 and later Saab models. The anchors attach to the vehicle and are used to secure a forward facing child restraint equipped with a top strap or top tether.

All child seats currently sold in Canada have top tether straps and some U.S. child seat manufacturers have announced they will soon provide top straps on their child seats. Many forward facing seats have the provision for top tether straps.

Top straps can make it possible to install a forward facing restraint more securely. However, the top tethers need to be properly anchored to the vehicle.

Saab has announced a new program which will provide one free anchor kit to any Saab owner of an affected car who requests it. Saab will also allow dealers to self-authorize the labor cost for installation as goodwill.

If you are interested in obtaining a tether kit, please contact the Saab Customer Assistance Center at 1-800-955-9007. Be prepared to provide your car's VIN so the correct kit can be ordered. Kits may be sent directly to the dealer for installation.

Cars affected
1989-98 9000
1989-93 900 (Not Convertible)
1994-98 900 (Not Convertible)
1989-94 900 Convertible
1995-98 900 Convertible

*Attaching tether hook to anchorage, 900 Convertible*

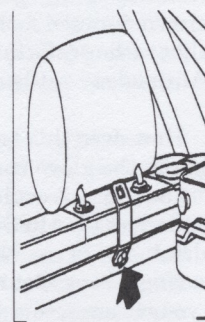
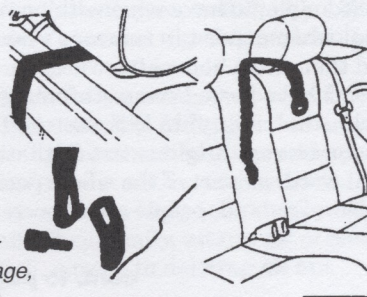

*Child restraint anchorage, 3- and 5-door 900*

## Requirement of 90.5 Octane in 225 hp engine

*Technical Service Broadcast - 9/30/97*

All 1996-97 Aeros with manual transmission and all 1998 9000 models with manual transmission require a minimum of 90.5 AON fuel as instructed in the owner's manual.

Using a lower octane fuel may result in an owner complaint of hesitation and can cause the Trionic ECM to record misfires in error. These misfires can be read using Tech 2. The recording of this misfire will in turn, trigger the MIL and set a DTC of P0300.

If diagnosis fails to pinpoint any other failure, verify with the owner what type of fuel is being used. If in doubt, fill the vehicle with the correct octane fuel, erase any DTC's and test drive to verify that the code does not return.

## "CHECK ENGINE" Light On and/or Driveability Complaint at 50-70 degrees

1996 900 with secondary air injection (Motonic 4.1)  
*Technical Service Broadcast - 3/4/98*

Some customers may experience a "CHECK ENGINE" light coming on during normal driving. While diagnosing this, a technician may read a DTC for "misfire." The customer may also experience a hesitation on drive away at an ambient temperature of 50-70 degrees.

If, after following ALL diagnostic troubleshooting procedures, a technician cannot identify or solve this complaint, please call the Technical Assistance Center for further guidance and assistance.

## No Weather Band on Radio

M98 900, 9-5, and 9-3 models  
*Technical Service Broadcast - 3/25/98*

Please ask your Saab PDI technicians to include a check of the weather band function when they check the radio operation at the PDI on M98 900, 9-5, and 9-3 models.

A customer may complain that the radio does not have the weather band function when the WB button is pushed or that they have difficulty tuning their favorite stations in the M98 900. They may report an extra digit on the display during manual tuning. To remedy this complaint, first record the customer's pre-set radio stations. These will be lost during this procedure.

1. Turn the radio off.
2. Push and hold the TUNE button and at the same time turn the radio on.
3. Continue to hold the TUNE button until the radio starts to operate.



4. Check that the WB function works.
5. Reprogram radio pre-sets.

This broadcast is being directed primarily at M98 900 vehicles, however the same remedy can be used on M94-97 model 900 models if there is a complaint of no weather band.

On some 9-5 and 9-3 models, the radio was incorrectly set to the European tuner standard rather than the U.S. standard.

U.S. standard, correctly functioning WB: SID will display Weather Band, Searching, or No Weather Band.

European standard: Will continue to display radio frequency when you press WB.

If the weather band function does not work when you press the WB button, follow the instructions below:

1. Turn the radio off.
2. Push and hold the SEEK button (in the center) and at the same time turn the radio on.
3. Continue to hold the SEEK button until the radio starts to operate.
4. Check that the WB function works.

## Noise from Speakers

M95-96 9000 models

*Technical Service Broadcast - 1/12/98*

Customers may complain that static is coming from the speakers. Usually, this problem should not be treated as poor radio reception since it can be present when using the cassette, CD player, or CD changer. The customer may state that they are encountering poor radio reception so the service advisor will need to question the owner to determine the source of the fault. The noise will typically come from only one speaker at a time. Should you encounter a customer complaint of noise coming from the speakers, use the following diagnostics to determine the source.

In most cases, the fault can be pinpointed to the main wiring harness routed through the console. This harness includes the wiring to carry the speaker signal from the radio to the amplifier. The speaker wires can be identified as the eight wires that are twisted together in pairs. These wires are picking up noise from the main harness, then transmitting the noise to the amplifier. The amplifier is then reproducing the noise. To address this scenario, access the main harness and extract the eight twisted pair wires. Wrap these wires in electrical tape and route them through the console away from the main harness and the antenna coaxial lead. Secure the harness so that it does not come in contact or in close proximity to any potential noise sources.

It is also possible that the harness is being cut by the two wire ties that secure it to the floorboard. Under the passenger's seat, below the beam that the front of the seat is bolted to, the speaker harness is tie-wrapped to the floorboard. There is a chance that the wire ties are too tight and the harness is being cut. If so, cut the wire ties, repair the damaged harness, and loosely re-secure the harness.

If the customer is encountering noise from the speakers that only occurs when using the radio (AM or FM), especially the AM band, the problem is likely caused by poor radio reception. In this case, the antenna and the antenna lead should be checked for proper grounding and continuity.

If the noise can be eliminated by disconnection the IAC valve, PSI 03/97-0751, published for the 900 model, may also be referenced to assist in diagnosing this noise.

## Intermittent Interior Light Operation

M97 900 5-door — See VIN range below  
*Technical Service Broadcast - 2/5/98*

Should a customer complain that the interior lights on their vehicle operate intermittently, it may be caused by too large a play between the front door switch and the door stop. Note that this only affects vehicles between VIN Serial No. Ranges V2039303-V2043433.

A new, shorter stop was introduced in production from VIN Serial No. V2036015. This can result in some problems due to different tolerances.

To address this concern, remove the door switch and fit spacer, P/N 49 47 149, between the B-pillar and the door switch. Reinstall the door switch and verify that the interior lights are working properly.

## Cupholder does not stay secured

*Late 1997 & early 900 models*

A customer may complain that the cup-holder in the center console attaches itself to their beverage container instead of staying in the console. The complaint may occur with a standard 12 oz. aluminum can and some fast food drink containers.

The problem has been identified with the rubber that holds the beverage container in place. One side of the rubber insert has a "slip" coating, while the other side is untreated. The side of the rubber insert with the "slip" coating should be in contact with the beverage container. The coating is to keep the rubber insert from adhering to the container. Use the following repair to address a customer's complaint of a cupholder that comes out of the center console.

NOTE: In some cases, the locking clip (PN 79 75 485) may not be reusable. The cup-holder assembly uses a total of four pieces. Most clips should be reusable.

1. Remove the cup-holder from the console.
2. Carefully remove the four round clips that hold the upper and lower pieces together.

NOTE: You can usually remove the clips without breaking them. We recommend that the clips be lifted away from the base of the cup holder with a thin screwdriver or a utility knife. Afterwards, grab the clips with needle nose pliers and "unscrew" the clip from the pin.

3. Release the locking tabs on the coin holder end of the cup-holder.

# SAAB BIG INVENTORY DISCOUNTS

WHOLESALE & RETAIL PARTS  
**FAST Delivery**  
HUGE INVENTORY INCLUDING SHEET METAL

10% DISCOUNT  
FOR CLUB MEMBERS





1-800-363-0741  
or 212-293-8275  
fax: 212-293-8271

**Zumbach** SALES  
SPORTS CARS PARTS  
SERVICE LEASING

FACTORY AUTHORIZED SAAB DEALER

629 West 54th Street, N.Y.C., N.Y. 10019  
NYC DCA #0698445•FAC#2391028

4. Holding the cup-holder upright, carefully separate the two pieces. Make sure not to lose track of the coin holder components.

5. Break the alignment pin off and turn the rubber insert over.

NOTE: It may be apparent which side is "slip" coated. This side typically appears lighter than the other side and has a slightly smoother feeling. If the "slip" coating is apparent, install the rubber insert so that the "slip" coating comes in contact with the beverage container. In any case, upon reassembly, pay close attention to install the rubber insert utilizing the new alignment mark.

6. Reassemble the upper and lower halves with the rubber insert properly positioned.

7. Snap the coin holder into the lower half of the cup holder.

8. Reinstall the four round clips that hold the two halves together.

Do not drill a hole through the cup-holder and console to secure it with a screw. This could route any spilled liquids or beverage condensation onto electrical components with the center console.

A change was made early in M98 production during November '97 to correct the cup-holders. Improved cup-holders are marked with a white paint mark or sticker.



## Will the "New" 2.3 Engine Please Take a Bow?

With the advent of the new 2.3 (major redesign, says Saab Sales literature), I got to thinking about the many engine designs we have worked on since the early 70s. The 1.7/1.85 liter Triumph engine was supposed to be a big improvement over the V-4 from the 96s. I'll bet there are a few of you who had timing chains break and maybe used everything but dynamite to get the head off. I've heard of engines being discarded because they couldn't get that pesky head loose to replace the blown head gasket.

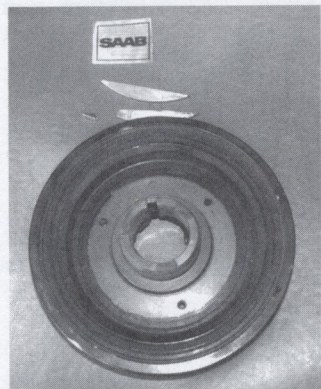
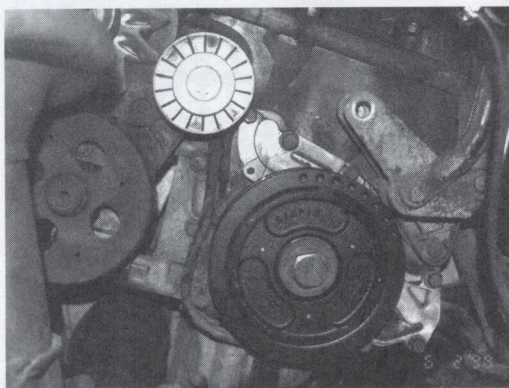

When the genuine Saab four-cylinder (2.0 liter) came out in '73, we thought it would be fantastic! Can you imagine that except for the soft spots like counter shaft, water pumps and cracked heads there was hardly any maintenance on those, especially after the electronic ignition in '78. Then, came the H engine in '81. No more counter shaft! Yippee! But even with the improved design, they did crack a head now and then. How about a crankshaft pulley coming apart? We've seen some of them.

The 2.0 liter 16-V, in my mind, was the best of the lot to this point. Oh yes, there have been some timing chains wear out, the head gaskets leaking to the outside of the engine and some of the crankshaft pulleys have separated but they have been an improvement from the previous engines. Actually,

they've all been good — much better than most all other brands — but we expect perfection from our Swedish friends.

When the 2.3 came out we had great expectations of getting rid of a few of the problems that have plagued Saab engines for quite some time. Once again, these are good engines but unfortunately they still suffer from the same maladies as their predecessors. This may not seem like an important issue but most all of you will own a 2.3 if you have a Saab. You should be attuned the the maintenance necessary to make these engines have long (yes, long) lives.

First, because of space, I'm going to spend more time on the crankshaft pulleys but you should be aware that the timing chains do stretch with the miles and should be checked each time you have the valve cover off or if it develops any noise. I don't have a clue how to describe in writing what a timing chain noise sounds like, but if you check your timing chain and it isn't loose and you still have a chain rattle, and the tensioner is good, then you'd better take the front cover off.

Check the chain, slide, etc., for the counter balance shafts. The counter balance shafts are driven by another chain that looks about as sturdy as a bicycle chain. It also has a tensioner and slides that need to be checked. It is just as important to be sure that this chain is okay because if it breaks, the timing chain is very likely to get tangled up in the shrapnel and fail as well.

When this happens, valves hit pistons and it could well mean an engine rebuild or replacement. Don't ignore any chain noise!

Picture No. 2 is the pulley that slides onto the crankshaft at the front of the engine. On a 9000 you probably can't see it from the top of the engine compartment but if you follow the accessory belt to its lowest point, that should be the culprit. Picture No. 1 shows the pulley viewed through the passenger-side fender with the plastic shield and wheel removed. This pulley drives accessories like the power steering pump, water pump, alternator and air conditioner compressor with the serpentine belt. This belt and pulley have to transmit lots of power. The belt drive is insulated from the rest of the unit with rubber. This keeps the noise, shock and vibration from traveling

through the engine. This same rubber insulation has failed on several previous different engine types and does so on the 2.3 as well. Picture No. 3 shows a pulley on which the rubber insulation totally failed and the outer ring knocked the plastic splash panels right off the bottom of the engine compartment of a 9000 when it flew apart.

The pulley slides onto the end of the crankshaft and an oil seal is used to keep the dirt out and oil in the engine. The crankshaft drives the pulley through the use of a woodruff key (shown in the picture). The key fits in a slot in the pulley and one in the crankshaft. Once the pulley is on the shaft and the key is in place the whole assembly is held in with a bolt in the end of the crankshaft. When the engine (crankshaft) turns over the pulley turns. The woodruff key drives the pulley on one end and on the other end drives the oil pump. Most engines are designed like this and it is an excellent way to get the many jobs accomplished without excess weight and bulk. The problem is that the drive keys wear or the pulley splits at the keyway so that the drive key is destroyed (we're not sure which fails first). See picture. The first indication of this failure may be a leaking front oil seal. After that, it could be an oil pump failure, or the belt not working which means no water pump (instant overheating of the engine) or no power steering, etc. I think you get the point.

When this fails, it could be catastrophic! You need to be aware when you have an unexplained problem that you must check it out immediately — the next oil change may be too late. These parts have been known to fail on these engines. We're not sure why. As a standard procedure in our shop we are now checking each car when the serpentine belt is replaced on a 2.3 engine. We take the pulley off the crankshaft and inspect the woodruff keys and the pulley keyway for cracking and wear. We also check the rubber insulating area for obvious failure. It takes a little more than an hour to accomplish this but it is well worth the expense when you balance that against the cost of the engine.

We would hope that our Swedish friends, seeing the multitude of crankshaft pulleys and timing chains that we as Saab owners have purchased in the past few years, would see the need to improve these parts. It is inconceivable that they could design and build an engine that goes several hundred thousand miles and have some components that just don't cut it.

Here's hoping that the new redesigned 2.3 never needs a timing chain, tensioner, or a crankshaft pulley.



~ Ring a Ding ~

# My Friend Roe

by Larry "Stroker" Williams

[Editor's note: About two weeks before Larry Williams died, he wrote this about his friend Roe, who has appeared in many of Larry's letters to NINES.]

I have been asked if Roe is a real person or just a shill for my Saab stories? Well, Roe is a person all right, but with all the trouble he gets into he is often asked, "Are you for real?" Things happen to Roe that just don't happen to other people.

Let me tell you how Roe got his first Saab. Scully — a guy we worked with down at the big green and yellow tractor factory in Waterloo — played the banker for his son's first car and anted up \$800 for a 1972 Saab 99. The sixteen year old got a father's standard set of rules about responsibility and was also instructed to regularly check the fluid levels on the Saab.

In less than a month Scully was fuming that the Saab smoked badly and only ran on two cylinders! He blamed the kid for ruining the car, repo'd it, then sold it to Roe for \$30 just to get it out of his sight.

Roe drove the limping Saab to his house and soon discovered the two additional contact points in the distributor, one of which was really oily! He checked the engine oil and it was way over full — in fact it was damn near level to the filler cap. The kid had topped off the engine like a radiator!

Roe drained off a gallon of oil and cleaned up all three sets of points. The suspect oily contact was now able to send a signal to the fuel injectors on the two dead cylinders.

Roe drove the smooth running, smokeless Saab, to work the next day and proceeded to needle Scully about his poor skills at teaching Automotive 101. He then said he would sell the car back to him for the going price of \$800! Roe got his goat so bad, Scully would not take the car back, even when Roe offered it as a gift!

Later Roe screwed up the transmission in the '72 and parked it in an open shed for a year. One day he borrowed my tow bar to get the car over to a guy who exchanges transmissions. Roe hooked the bar to the front bumper and pulled, but the car refused to come out of the shed. Roe thought the wheels had settled in the dirt so he just shifted into low side of his 4-wheel drive pickup and gave it a jerk. Roe drove down the lane till he noticed the car was still in the shed! He got out and found the tow bar and Saab bumper hanging on his hitch! Only then did he remember he had set a large block in front of a rear wheel.

Well it was a just like a Laurel and Hardy movie; Roe had moved the Saab enough to get it over the block and now it was rolling down hill right into his pickup! And it did!

A few months later Roe borrowed the bar again to tow his son's Honda from Omaha. Somewhere close to Des Moines the Honda, minus the front bumper, tried to pass Roe on the right side just before it went in the ditch. Roe now refers to that tow bar as the "bumper puller!"

After the '72 got its transmission transplant, Roe felt that the guy still owed him from a previous deal. So he took the car back for a front bumper transplant, which turned out to be a large diameter steel pipe welded in place! In addition he also received a free tune-up!

This next happening didn't make much sense to me but these two guys swear this is factual. They put in new plugs but got the firing order completely backwards with #1 cylinder up front! They said the engine started, ran backwards, and went to full RPM!

## R.A. MOTORING 'The Saab Kiosk'

- ..Front Vanity Plates - Dress up the front of your Saab U.S. Sized - Black Saab logo on chrome or gold chrome background or choose chrome on black at \$25. Also on stainless steel background for \$27. We also have Swedish flag plates at \$27. Celebrate 20 yrs. of Turbo-charging with a '78 Authentic Design Logo Plate - chrome on black for \$30.
  - ..Eurosize - Choose from Swedish flag; authentic Swedish or customized "Luv my Saab" etc. at \$35
  - ..Air Valve Caps - The ultimate in wheel detail for the Saab nut! Griffen Logo on Graphite, Aluminum or Chrome at \$14
  - ..Matching Key Fob - at \$14 or \$25 for set
  - ..Saab Parking Only Signs - red on white lettering at \$20
  - ..Street Signs - 9000 Aero Blvd, 2cylinder Ln. etc. white on green at \$25
  - ..Grill Badges - Griffen or Swedish Flag at \$16
  - ..Mylar Country Ovals - at \$5
  - !!Special - With any order receive a Mylar oval free!!
- \*\*\*All prices include shipping\*\*\*

\*\*\* Call 1-888-411-2205 or visit us at <http://www.virtualscranton.com.ramotoring>

## Intellect Corp. Intelligent Car Parts 1 (800) 326-0599

*Classic 900 parts.*

Ball Joints	\$22
Tie Rod Ends	\$22
Brake Rotors, Front -87	2 / \$45
Cam cover gasket 16V	\$18
Crank Pulley Rebuilt	\$98
Brake Master Cyl. New	\$98
Wheel Bearing, 81-	\$31
Heater Valve new style	\$67
Clutch master cyl. New	\$59
Water pump "German"	\$34
CV Joint, outer w/boot	\$99
Belts, complete set	\$27
Clutch slave cyl. New	\$72
Clutch kit w/slave	\$199
Radiator copper H/D	\$155
EFI computer Rebuilt (bosch #s ending in '536;564;570;580;585)exch.	\$240
A/C hose suction/discharge hose	\$79
2.8 BAR fuel reg. for 185HP 900T	\$81



# Saab Klinik

by Doctor Nio

I have a beautiful '78 EMS. Great original shape, and all original. It was manufactured in November of 1977, and was purchased in Virginia, so it has emissions which are not intended for California, in case that makes any difference in '78.

There is one problem which has plagued it for a long while now and even the best Saab folks in the Washington, DC area are unable to help.

There is a constant smell of gasoline in the car. The smell is quite strong, though not noxious, on hot days. I have replaced fuel lines, accumulator, fuel cap, sending unit gasket(s) and pump gasket (at the tank). All has been to no avail. Earlier in its life (about 1982) I had the problem and replaced the sending unit gasket, which seemed to correct the problem at that time. The current smells began around 1990 and have persisted, despite my efforts. Of course, the dealers and shops just say, "It's just the way Saabs are." But I know better.

Can you advise what might be the problem?

**Bill Frye**  
Alexandria VA

*The best way to find a fuel leak is with the use of a gas analyzer. The fuel tank should be pressurized to approximately 3psi (no more than 10psi). Pay special attention to the flex hoses in the filler neck. The rubber cracks from the inside out which makes it hard to find. Older fuel tanks, made of metal may be hard to seal. Use GASOILA, or a similar product, when the sending unit or pump seal surface is deformed.*

Thanks for the great column in the Nines. This car starts rich. If left outside with NGK plugs in it it just floods. With Champions in it, it will start, but runs very rich for 45 sec. or so. I have repaired a bad ground, found that the AIC would change idle if I tapped on it, so therefor replaced it, and threw in a new FI temp sender (centre of int. manifold) for good measure. Idle is about 1000 when running rich, and then up to about 1200 after that 45 sec, then back to 900 when warm. I would very much appreciate any ideas you may have.

**Jason Yardley**  
Wasilla AK

*One thing to check would be the ground to the ignition module (pin 2). Saab published a repair procedure for this (PSI dated 03/91-0093). The repair for this is to run a new ground wire from the right inner-fender area to pin #2.*

I have a simple question that has been unanswered by SAAB USA and SAAB Sweden.

My 900 takes type F transmission fluid. Can I use Dextron/Mercon in place of F? If not, why not? Any direction would be greatly appreciated.

Thanks,

(No name)

*The only difference between ATF and Dextron is the ATF has a friction modifier required by some transmissions. There are friction modifier additives available, but a Borg Warner T-37 is no place to experiment.*

I have a 95 Saab 900S with an automatic. Recently on morning start ups the tranny when first put in gear (Drive) will do something strange. First the "check gearbox" light goes on and the tranny is in highest gear. The dealer checked the computer (no fault codes) and cleaned some contacts and said they could find nothing wrong. It still happens though about every other morning.

If I put it in Reverse, nothing wrong, but shifting into Drive I get the light and the high gear. I can manually go to first etc. but in Drive it's always the highest. The dealer says that that is "limp home" mode for the tranny but still doesn't know why it's happening any ideas?

**Bob Brooks**  
Suffield CT

*The transmission in your 900 is electronically controlled. A "check gear box" light, and the high gear selection, is an indication that the transmission is in "limp mode". Your problem may stem from improper start up voltage. The electrical part of the ignition switch may be the culprit. Power is provided from the +15 distribution point through the ignition switch to pin #17 of the TCM. A 'voltage drop' test may be the best way to diagnose the fault.*

*Sometimes cycling the ignition switch may temporarily 'fix' the problem and give a quick indication of what's wrong.*

My 91 900 SPG has:

1) a rattle in the right rear when it's moving. I thought it was inside but now think it could be a rear shock.

2) is lower on the right rear than left rear. I thought it was supposed to be lower on the left rear due to the Panhard rod.

3) the parking brake does not work on the RR, but does on LR.

**Tom (Tlc45@aol.com)**  
via email

1) Every 900 (and 99) should have the suspension bolts torqued at every major service. We find the most common rattle to be a loose trailing arm, followed by the Panhard Rod or axle mounts.

2) The question of a level Saab of any model has been going on since the early 1960s. A perfect one is rare.

3) The best advice we can give on the hand brake (a.k.a. parking brake, emergency brake) system is to get the service manual and get to know how it works.

*Most of the problems we see are related to an improperly performed pad replacement and the subsequent adjustment.*

I own a 1986 900 3-door 8-valve with approximately 130,000+ miles (the odometer stopped at 69,000 miles), with a 5-speed transmission. I enjoy, and take pride in repairing and maintaining my car myself thanks to advice from the NINES Magazine and a Haynes manual. Can you please advise me on the following:

1. After draining the transmission/differential and refilling with Red Line MTL fluid I noticed leaks at the trans/diff dip-stick and at the passenger side differential/axle housing where the leak drips onto the exhaust header and stinks. I removed the MTL and put in 10-40 motor oil, replaced the seal and rubber boot on the dipstick socket, and got thoroughly confused after reading the Haynes manual on what to do about the diff/axle seals. Can you explain what I need to do after removing the drive axle?

2. The brake vacuum booster has a slight internal leak (which I can hear hissing after the engine is turned off). The brakes work fine with plenty of assist, but I wonder if the leak leans out the engine. If it does, would putting an external non-return valve in the vacuum hose work to prevent the engine from getting that air?

3. The heated seats do not work in the winter, yet once in a while they will come on when it is 70 F outside. I tested for power to the heating elements and found no power at a temperature of 35 F. I have no idea where the other components are in order to test them! Can you advise?

4. When I replaced the valve cover seal, I noticed the distributor drive had approximately 1/4" of side to side play. Is that a problem?

5. Lastly, the cylinder head bolts look like they are from another planet. What type of socket will work and where would I find one?

**Ed Schaffer**  
Baltimore, MD

*1. The driver housing must be removed to change the seals. This is done by removing the bolts holding the driver housing to the transmission. Once removed, you will find a clip on the inside of the driver housing. From this point it should be clear what has to be done. Upon reinstallation, note that the 'top' is clearly marked.*

*1. There's a caution here, the MTL fluid is a gear lube. It's not advisable to make the transition to mineral oil after using gear lube. We have found that rapid pinion bearing failure occurs shortly after the change is made.*

*The axle seals can be replaced using the following procedure:*



# 900 - 9000



**1-800-241-1916**  
770-475-2662 Local  
770-475-2663 Fax

Visa - M/C  
Disc - Amex  
COD  
UPS - Motor Freight

New Arrivals Daily  
Fair Pricing  
Call for Quotes  
Now carrying Volvo parts, too

Put the Saab in the air on jack stands, remove the tires, and unbolt and secure the brake calipers. Place a floor jack under the A frame as close to the ball joint as possible. Raise the jack until there is enough space between the upper A frame and the body to insert a nut that's approximately the size of your axle nut, or insert the special tool. Remove the jack, the two bolts that pass through the upper ball joint. Loosen the hose clamp that secures the boot to the inner driver. Insert a large screw driver into the back part of the ball joint and A frame. Pry upward until the ball joint slides out of the A frame. Reach through the axle opening and grab the edge of the boot, then peel it away from the inner driver.

Remove the bolts from around the axle driver housing. Do one side at a time. Extract the driver and housing together, as one unit. After unit is extracted, note the C clip on the inside driver shaft, remove the C clip. Remove the plunger and spring out of the end of the shaft. Holding the housing in your hand, use a soft mallet to drive the driver out of the housing. Once the driver is removed, the seal is exposed. Use an old screw driver to pry it out. Take note of the seals mounting depth.

Install new seal and reverse the above procedure, making sure to use plenty of grease while inserting the axle driver. You may need a small piece of metal pipe to hold the axle driver bearing in place while reinstalling the driver. Always install a new driver housing O ring and grease it also. Make certain the spring and plunger are in position too. When installing the axle driver bolts use a little sealer on the threads. Tighten all bolts evenly to pull the housing

against the case using a torque of 18 to 20 ft lbs.

2. The hiss you hear from the brake booster may be from the ventilation controls. However, I have seen the booster do the same. If any change is noted in the power brake assistance you should replace the servo, as it may become a safety issue. In early stages it causes no problem with lean run conditions, however, in later stages it will interfere with run condition severely.

3. Your heated seats have a thermostat at the heating element for the earlier system that has no dash control switch. It may be at fault. The usual problem when seat heaters stop working is in the heating element. It's advisable not to kneel on the seat bottom as that may break the wires of the element.

4. The distributor drive is designed to slide on a centering pin. There is no problem as long as the center axis is maintained. Some play is normal, however, 1/4 inch sounds excessive. If your Saab is running okay, I would leave it alone because of the expense.

5. Cylinder head bolts are an inverted 12mm torx. I've always bought mine from Snap-On.

The cruise control of my 1990 SPG has recently been getting "tired." The symptom is that I set the cruise control and it does take over throttle control, but gradually loses speed, especially uphill. Any ideas? The car has 76,000 miles and is always garaged.

**Wes Verkaart**  
Duxbury, MA

*The most frequent problem of Saab cruise controls*

is the vacuum hoses. Check the hose that plugs into the pump, usually at that end they crack and split. For added strength we use 5mm braided fuel line to replace the original hose. To test the vacuum circuit, remove the hose at the pump and apply a negative pressure. The throttle should open. Any leak down indicates a leak in the circuit.

On 1992 - we are seeing ECU failures. ECU failures are rare on early models. If you apply the negative pressure to the hose and the throttle fails to open, check the dump valves at the pedals. These valves are adjustable, if any work has taken place nearby they may have been moved accidentally.

I am planning to install a Clarion CDC 635 CD changer in my new Saab 900SE. Since it is a different size than the CDC 605 used in 1996, can I still use the Saab-supplied mounting bracket? Will Saab soon come out with a new bracket? Thanks!

**Tom Rose**  
White Bear Lake, MN

Saab issued a Parts and Service Information bulletin on installing the Slimline CD Changer (p/n 02-49-870) a couple of years ago. Ask your dealer for PSI 03/96-0673. It may be found in Parts & Service Information Supplement 1/96-12/96 (p/n 02-18-347).

The bracket kit to fit the Slimline Changer in a 900 is p/n 02-49-920. If you are upgrading from the older changer, all you need is kit #02-49-888.

**cont. on page 27**



# Technical Talk

## Reproduction Minilite-style Wheels

One of the most popular add-ons to personalize any car is wheels. In the case of the Sonetts, a Minilite-style alloy wheel made by Ronal was available from the Saab Accessories branch and made the little fiberglass sports car look a little sportier. The original 10-spoke wheels have now become prized and often high priced items for collectors of Sonetts and 96s.

Enter The Saab Owners Club of Great Britain. For the past several years they have tried to get the new owners of Minilite, Ronal or some other wheel manufacturer to reproduce the popular wheel in the unique 5-bolt pattern common to the early Saabs. After several years of trying to make arrangements, CompMotive has agreed to make a limited run of the wheels. They are the 5Jx15 (15" diameter, 5 inches wide) size, visually like the earlier Ronal wheels but with stronger bracing in the back. They are so strong they will be acceptable for rally and racing use.

The deal has finally been finished and the first run of wheels has been manufactured. The first run is 250 sets of wheels, but there are still some available. The cost of manufacturing and the distribution is being handled by Highgate Saab in England. The contact there is Melvyn Windsor. Their address is: Highgate Saabpart Ltd., 17 West Bromwich Road, Walsall, West Midlands, WS1 3HY. Phone: 01922-622695/723602. Price on the wheels is £140 GB apiece plus taxes, duty and shipping.

Bud Clark at J&B Imports in California is considering handling the Minilites in the U.S. Though a price has not been finalized, they are expected to run roughly \$250 to \$300 apiece, depending on the exchange rate and shipping costs from England. If you are interested, call Bud at 714-282-7378, or send a fax to 714-282-0457.

## V4 Tips

One correction to my last letter. Charlie Tompson (not Tompkins as I had misspelled it) of Back Bay Automotive, 66 Cove Street, Portland, Maine.

## Oil the distributor on a V4

In summer 1996 I had a decrease in power, and it got so bad I decided to drive to where I knew was a vacuum gauge to do some diagnosis. It ran if I kept to the same speed but was difficult going, and I only got as far as Portland (Maine) where my sister was then residing.

The next day at Back Bay Automotive (66 Cove Street), I told Cy Tompson the symptoms. He went directly to the distributor, muttered something about nobody ever oiling the thing, oiled the felt pad inside the shaft, installed new cap and rotor (needed it anyhow), and then it ran fine. Apparently the springs on the weights (which alter the timing at higher rpm) get rusty and stick, affecting the timing and thus the running. The Haynes manual does not stress this maintenance but its Figure 4.1 on page 67 (Saab 95/96 V4 Haynes Manual) does show a "Lubrication pad" within the shaft, and it should be oiled every tuneup.

An acquaintance with a later model 96 also had his distributor act up the same way as mine within a few weeks, and got the oil treatment, which cured it. Apparently after a decade or two of neglect the springs get a bit rusty, so it might be useful to oil that place the next time one tunes up a V4.

## 95/96 V4 Hints:

**Shock Absorbers:** Front ones I have used Beck/Arnley 114-0243, which cross references to Sachs 846 001 (on the box), but I recall the last time I couldn't get the B/A ones for some reason, so found some that were 1 cm shorter, figured maybe the springs had sagged 1 cm anyhow, so bought and used them. These were Monroe 33076, and I knocked out their bushings and used my old ones as they fit better.

Incidentally, if one had terrible rackets gong over bumps, it might not be the car coming apart, but the shock absorber bushings wearing out (the holes spread and so the bolt rattles). I had this happen recently and took out the remaining factory bushings replacing them with my good old bushings.

**Oil Pressure Switch:** I have part #201-0064 listed in my book, which looks like a Beck/Arnley number, better check it.

**Coil:** Beck/Arnley 178-8009. Check to see whether has an internal or external voltage regulator.

**Alternator Brushes:** I have been simply replacing the brushes, soldering in new ones, every few years, a lot cheaper than replacing the whole alternator. I use Standard GB 292.

**Deceleration Valve Diaphragm:** On V4s with Ford carbs, if you hear a whistle all the time except during acceleration, pull over and test it by putting finger over hole on bottom of unit while running and if whistle stops you are lucky,

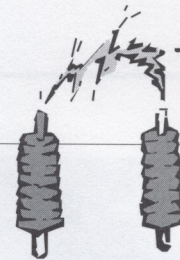

duct tape over it and drive to auto parts place and get dec. diaphragm Beck/Arnley 167-8002, and do it. If you're not so lucky and the thing tears worse, no whistle, car doesn't run, got to replace it anyhow.

The funniest one I ever saw was due to a small leak under the dash board. This made a small water spot on floor, but as it was so infrequent I ignored it, often have carpet out so not worried about rusting the floor (which has been welded then sealed). It drips out sometimes upon left leg but not usually a nuisance.

One day I noticed the lights weren't blinking. The fuse was okay so I figured the **flasher unit** had worn out. This unit looks like a miniature tin can, and makes the clicking noise as the signal lights blink. This unit hangs out by its wire sometimes visible, I usually stuff it back under the dashboard, but I was glad this time it was so accessible. It was also warm, so I figured I had found the problem. However, when I took it out it was also heavy, being full of water. I pried back the crimped metal to open it, dried out the can, used a hair drier on the electrical unit (it looked like new), put it back in its can, sealed it up to keep water out. Evidently the water had run down the wire into a tiny air vent in the unit, filling it up over a period of time, until it didn't work. It now works fine.

Oh yes, the infamous **heater closure valve**, when one can't quite shut off the warm air. Some have replaced the coolant valve (see Saab Club Newsletter, June 1980, page 3). I figured the problem lay in not being able to shove the lever down far enough, so I lay on my back and with a screwdriver undid the screws holding the cable housing under the lever, and with pliers shoved the housing over and clamped it down again. Thus the cable, in relation to its housing, was further in when the lever was all the way down, and it was just enough to keep the valve shut off.

I had **trouble getting the spare tire out** from under the seat in the 95 (many use a very slightly larger tire than originally recommended). Have to move front seats way up. Tire still hit the seatbelt loop, so I took it off and turned it around. It works just as well and gives room to get the spare tire out.

Several years ago I had **trouble getting into certain gears**, either the top or bottom, or front or back, anyhow they came in pairs. My father told me probably nothing wrong with the tranny, but the gearshift rod might need adjustment. Using the Haynes Saab 95/96 V4 manual,



chapter 6, section 16, and a Saturday afternoon, a screwdriver and a rubber mallet, and lots of patience, got it where I wanted it. Don't loosen the screws more than you have to. Bang too much one way, you shift it over, have to move it other way. As with adjusting the points gap, do it only when you have lots of time and patience. This is less expensive than paying hundreds of dollars having someone check the transmission. Do the easy solutions first, as they might need adjustment by now.

Most of those familiar with the **Ford carburetor on the V4** probably are aware of the little rod and ball which likes to roll away somewhere you can't find it. I keep a few spare ones handy. The rod is simply a weight, can be made of a coathanger wire 1/8" diameter, cut to 9 mm long. The ball is a valve, 0.156" diameter, can be replaced by a 5/32" ball bearing (5/32" = 0.156") such as sold in some hardware stores for a few cents each.

Those **old hourglass exhaust hangers** were a pain. I eliminated them with use of cutting extra mudflap rubber and drilling holes, making my own exhaust hangers which last better and longer. The bracket holding up the middle of the exhaust pipe is necessary otherwise the pipe will develop cracks in it; it needs support.

If someone tells you your engine is "shot," just because it's an old car, get a **compression tester and a vacuum gauge** and use them. They are wonderful tools to diagnose how engine and carb are running. That plus knowing mpg, oil consumption is about all you need, except of course to change balance shaft bearings and gear occasionally, and of course hardened exhaust valves and valve seats (to allow the use of Unleaded gasoline) if it hasn't been already done.

**I don't drive in my old Saab (95) without tools**, spare ignition parts, fan belt, and a spare distributor and spare fuel pump. Epoxy, silicone cement, duct tape, spare nuts and bolts, bulbs, wire, coathanger wire, are also very useful. I also keep a small hatchet and hand pruning clippers; in case I get stuck I can make a traction mat out of brush. This has gotten the car out of scrapes that I shouldn't have gotten into in the first place.

A brother gave me a book which I have had a hard time finding its review in Nines. It is **The Saab-Scania Story**, published by Streiffert & Co., Bokforlag HB, Box 5098, S-102 42 Stockholm, Sweden, @ Saab-Scania AB, 1987, written by the Saab-Scania Editorial Board and Editorial Committee. 169 pages. Its review must be in one of the issues, somewhere!

A letter published in the June 1980, page 4, newsletter, seems pertinent today:

**"HE WANTS MORE 96 TECH" TIPS  
BY STEVE LAXTON, WAYNE, PA**

"What is happening with the Newsletter? There seems to be more and more official service tips from Saab-Scania, and fewer and fewer articles from members. I realize this isn't

your fault—if people don't write in their tips and service experiences, you have nothing to publish. The service bulletins from Saab are okay, but many of them require specialized tools or facilities that the average Saab owner doesn't have. I joined the Club because I was interested in how the average member was able to solve problems and save money with the limited resources at his command.

"Let me add my voice to yours, and urge members to contribute to the newsletter. If you belong to the Club, it is unfair to just take from the newsletter and not contribute to it. Anyone who does any major mechanical work on his Saab should be able to provide several articles on what he has learned from his experience which will benefit other club members. And even those who let others do most of the work on their cars should be able to contribute at least on hint, tip, or lesson learned during the course of the year.

"Lets all make a bigger effort to contribute to the newsletter, and thus to each other."

*Dana Morong*

## 9000 Suspension and other tips

Finally took a moment to write up some tech tips for you and the club.

**9000T rear suspension rebuild** - My wife's 1990 9000T was a European delivery model, with several non-typical goodies such as a "red box" computer, sport exhaust and 16" wheels. Also came with evidence of being driven on heavily salted roads. Anyway, when I jacked it up to change to the mounted 16"Gislaved snows, the left rear shock gave a sigh and puked its gas-pressurized fluid on the garage floor. If this has not yet happened to you, I suggest putting the floor jack under the rear control arm, so the shock doesn't fully extend.

Seems some 9000T and most CD models are equipped with **Nivomat** self-leveling rear shocks. You can recognize these, as they have an accordion-pleated boot and are larger in diameter than normal rear shocks. The Nivomats enable carrying max GVW without the rear sagging or dragging. They also dealer list for **\$480 each!** Neither my local wrecking yard nor Dennis Sweeney had any Nivomats, but would sell me the standard shocks as well as the rear springs which would also have to be swapped in, for only \$100. This was tempting, but I buy and drive a SAAB Turbo because it handles roads and loads better - not cheaper.

Some checking with local and national wholesale parts houses finally found a price under \$500 for the pair of Nivomats. Even though only one had leaked, at 100k mi, it made sense to replace both. (I'll make someone a deal on the still-working right side unit.)

# SAAB ONLY

NEW/USED/REBUILT

## SAAB PARTS

900 Heater Valve	\$69.00
900 Water Pump	\$39.00
99/900 ball joints	\$24.00
900 A/C Receiver/Dryer, -86	\$39.00

*Everything Discounted!*

Visa & MasterCard

**800-583-0370**

in NJ 908-788-7222

Moncrief Marketing, Inc.

Flemington, NJ 08822

Naturally, I waited until the night before we were leaving on a trip to begin the chore. The top mounts came undone easily, but the bottom bolts, which also attach the rear sway bar ends, were rusted solid. The bolt heads would not move, but after much grunting and profanity, force applied to the rusted nut finally did twist the attached bolt in half right behind the nut. No amount of force which I could apply in the tight confines under the axle would move the remaining part of the bolts sideways out of the shock and sway bar bushings.

About midnight, I gave up, disconnected the rear brake calipers, upper and lower control arms and sway bar and removed the rear axle assembly. A hacksaw removed the bolts in three pieces, but the section rusted inside the sway bar bushing would not drive out. Heat would have destroyed the rubber bushing, which is not a stocking part at most dealerships. By 2:00 AM, I had used a drill press to drill the bolt out of the bushing and gone to bed. Naturally, the bolts are not a dealer stocking item either, so a trip to Fasteners, Inc found replacements. By noon I was back on the road.

**Note:** Any time you are under the rear of a 9000, check the front mounting bolts on the lower rear suspension trailing arms. On an '87 I had just bought and was driving cross-country at a goodly speed, these worked loose and **fell out** when I stopped for gas and was backing up!

**to next page**



Had it happened at an inopportune time you might be reading this as a posthumous "cause of fatal accident report."

**9000T front end rebuild** - On I-90 in Montana, there are plenty of high-speed curves and through these the rear sat higher and felt tighter than in recent memory. Also, it made me begin thinking about the front suspension - why have the new good stuff on the back end and 100k mi of wear on all the steering stuff? I began to gather parts without regard to whether the ball joints, outer steering rack ends or struts were actually leaking or clunking yet. Everywhere I went, the dealer, independent shop, or parts guy each said, "Gee, never ordered one of those before." When I got the struts off, for instance, the old one needed less than half the force to push it down compared to the new one. If no one is buying front end parts for the 9000's, it is now obvious to me most of them out there could benefit from a front end rebuild.

One caveat, I do not know how to remove and replace the front Mc Pherson strut springs without a the special compressor tool shown in the manual. I bought a professional quality Mac version at a pawn shop for \$100. They can be rented at the larger tool rental shops. With the tool, it is a piece of cake. On the 9000 front suspension, any part: strut, ball joint, or steering rod end, can be removed and replaced without disturbing any of the others. However, I just did them all while I was there.

The only difficulty in reassembly is tightening the nut on the top end of the new strut. There is a Allen hex recessed in the top of the shaft. An Allen wrench is inserted to prevent the shaft from turning, which might harm the internal valving. However, the top of the strut is covered when a socket and ratchet is put on the nut. The nut is recessed below the inner fender sheet metal, so a wrench cannot be used. My solution was to put a socket on the nut, insert the Allen hex wrench through the 1/2" square hole in the top of the socket and then use large slip-joint pliers to turn the socket. It hurt to put pliers jaw scars on a \$20 Snap-on socket, but I couldn't figure another way to tighten the top nut once the strut was in place.

I did a tape measure toe-in alignment and took it to a shop. "First one of these I ever saw," he said. My toe-in was close, but both steering track rods needed a couple of turns to center the steering wheel. It now rides and drives like a new car.

**9000 Clutch Master Cylinder Fix** - Every SAAB I have ever owned, be they 99's, 900's or 9000's, has had a failure of the clutch master cylinder. In addition to the rubber seals failing, the clevis holes wear egg-shaped and thereby loses pedal travel and precision feel. Someday I am going to Trollhattan and find the engineer in charge of hydraulics. Then I will bring his professional shortcomings to his attention by beating him about the head and shoulders with a 1973 master cylinder in one

hand and a 1990 in the other. After 17 years without fixing an obviously flawed design, he deserves no mercy!

Anyway, soon after purchasing the two-year-old 1990 9000T, the clutch master stopped working. It was slugged up, full of black crud. No rebuild kit was available at the time, so a new cylinder set me back \$112. I know silicone brake fluid is not recommended with anti-lock brakes, but after experiencing 10 previous master cylinder failures and now seeing the condition of the OEM fluid in this clutch cylinder after only two years, it is obvious Saab's advice in this area is suspect. I completely flushed the brake and clutch lines and cylinders and used silicone fluid throughout.

However, while the antilock brakes seem to work fine, I really can't claim I fixed the clutch master cylinder problem by using silicone fluid, since about three years later the same condition has returned. Probably the clutch system needs flushing every year, regardless of the fluid used.

Remembering the original cylinder was just slugged up, but not completely worn out, I decided to try a cleaning. Removed and disassembled the clutch cylinder, washed everything with alcohol. Blew the in and out ports with compressed air - sure enough, lots of crud, but less after a longer time than with OEM fluid. The four bleed holes in the pressure piston head were full of crud. An appropriate size wire or drill bit will move the crud, being careful not to puncture the top of the rubber seal under the piston head. Follow with compressed air to blast out the little bits. Rinse with fluid and reassemble.

The wear in the clevis holes is a bit more of a challenge. Since the clevis cannot be separated from the piston, the easy fix of welding washers to the outside edges is not safely accomplished. My hardware store solution was to buy a couple of 5/16" i.d. and 1/2" o.d. brass bushings each 1/2" long. I drilled the clevis hole out to 1/2", which removed the egg-shape wear. The bushings press into the holes until they are flush with the inside of the clevis. The original clevis pin is now too short. A new 5/16" pin the same diameter (.310) as the original clevis pin, but approx. 2" long will suffice. The brass bushings will restore the like-new feel to the pedal and one hopes, keep it that way forever.

**Direct Ignition Modules - symptoms indicating incipient failure thereof** - Many 1990 and later engines with Direct Ignition can expect a failure of this \$500 item at between 60 - 100k mi. Symptoms include a random "hiccup" under load, engine occasionally dying when returning to idle, and eventually random failure to start when warm. These occurrences will gradually increase in frequency. The only cure is to replace the Direct Ignition Module. It is spendy, but I wore out a starter trying to trouble-shoot the problem, hoping it was something less expensive.

#### Tech Questions for members:

1 - Every high mileage 900 of my acquaintance has had wiper system failure. Either the cable breaks, jumps off the pulley, or the shaft loosens in the pulley. The fixes are simple, but I cannot figure how to get the assembly out without removing the air conditioning compressor. Any tips out there?

2 - Headlights on 87+ 900's and 9000's are scandalously poor. I must make a note to also beat up on the lighting engineer on my fantasy trip to Trollhattan. To see really good headlights on a Swedish automobile, drive a Volvo 850 or S70. I tried the made-in-Taiwan high wattage bulbs, but they only last a few months. Any solution, (other than \$500 Euro conversions), to the clouding of the lenses and the poor beam pattern?

— Jack Vines  
Spokane WA

## Auto PC

Hey, what's going on? It's almost 2000. So where's my flying car? Popular Science promised me one and I've been waiting a very long time. Sure, I have a Saab or two and they have flying in their heritage but it's still not George Jetson time. And I do have a computer in my car that is more powerful than the unit that helped Apollo get to the moon and back. I want more toys and I want'em now!

Okay, there is a new toy for your Saab that almost makes it seem like you are flying. I'm talking about the Auto PC, a new type of automotive computer to link you with the electronic age. No, it's not something to prevent problems in the office or house, even if it's white, but an in-dash computer/entertainment/PIM {Personal Information Manager} that links to your Palm or Handheld PC via an infrared port.

The Auto PC is controlled by Microsoft's new Windows® CE 2.0. Via voice commands or simple pushbuttons on the unit, the user can select a radio station, a track on a CD, or dial a number on your cell phone. Future additions will add such applications GPS (Global Positioning Satellite), a handy tool when driving in an unfamiliar area. Wireless support options provide traffic assistance and with spoken commands to the supplied navigation system, your hands are freed from dealing with maps, allowing you to gesture at other fellow drivers as need arises.

For more information:  
<http://www.microsoft.com/windowsce/autopc/about>  
<http://www.autopc.com/>

— Paul Florance  
Seal Beach CA



# Sonett Brake Master Cylinder Rebuilding

Eighth in a series of articles on Sonett restoration by Bruce Turk, VP, New England Sonett Club

All 1967 through 1974 Sonetts and 1964 through 1969 95s and 96s use what is referred to as a type III, two-circuit brake master cylinder. Although the master cylinder lid (5) differed on some models, the interior parts remained the same. The master cylinder has two separate chambers. One controls the right front and rear wheel and the other the left front and right rear wheel. The reason for this was so that the car could be stopped safely with a broken brake line or leaking master cylinder chamber.

A poorly functioning brake master cylinder can show some of the following symptoms. Spongy brake pedal due to worn primary or secondary cups (12) (15) (21). Very firm brake pedal due to clogged bypass ports (3) (4) (6) (7), resulting in brakes hanging up. NOTE: the most common reason for brakes hanging up is clogged rubber brake hoses, not brake master cylinder problems. And lastly, brake fluid loss caused by a failing secondary cup (26).

Master cylinder rebuilding can be accomplished in two ways. You can send the cylinder out for resleeving and rebuild for about \$175, or you can buy a rebuild kit from Saab for \$22 and do it yourself. If after disassembly you find that the cylinder bore is deeply pitted, I recommend resleeving.

Resleeving and rebuilding can be done by White Post Restorations, One Old Car Drive, White Post, VA 22663, (540) 837-1140. Included in White Posts \$175 fee is a full life time warranty.

Now then, since most of you love a good challenge and would never pass up the opportunity to save over \$150, I have put together the following "easy to follow" rebuilding instructions.

Before we begin I must warn you. The only brake master cylinder parts that are available from Saab are contained in their rebuild kit (#7836430). All other parts, not to mention a complete new master cylinder, are no longer available. The master cylinder contains a plethora of tiny spring-loaded pieces that have been waiting for decades to go twanging across your garage floor. You must be diligent and creative to curtail their quest for freedom.

Let's begin.

1. Open the brake fluid bleeder on the right rear wheel, pump the brake pedal until the fluid stops running out. Repeat this procedure, one at a time, on the remaining wheels.

2. Remove the rubber hose that goes in to the master cylinder lid (5) if so equipped.

3. Loosen, but do not remove, the steel brake line fittings where they screw into the banjo fittings (32). Disconnect the wires that go to the brake light switch, unscrew switch.

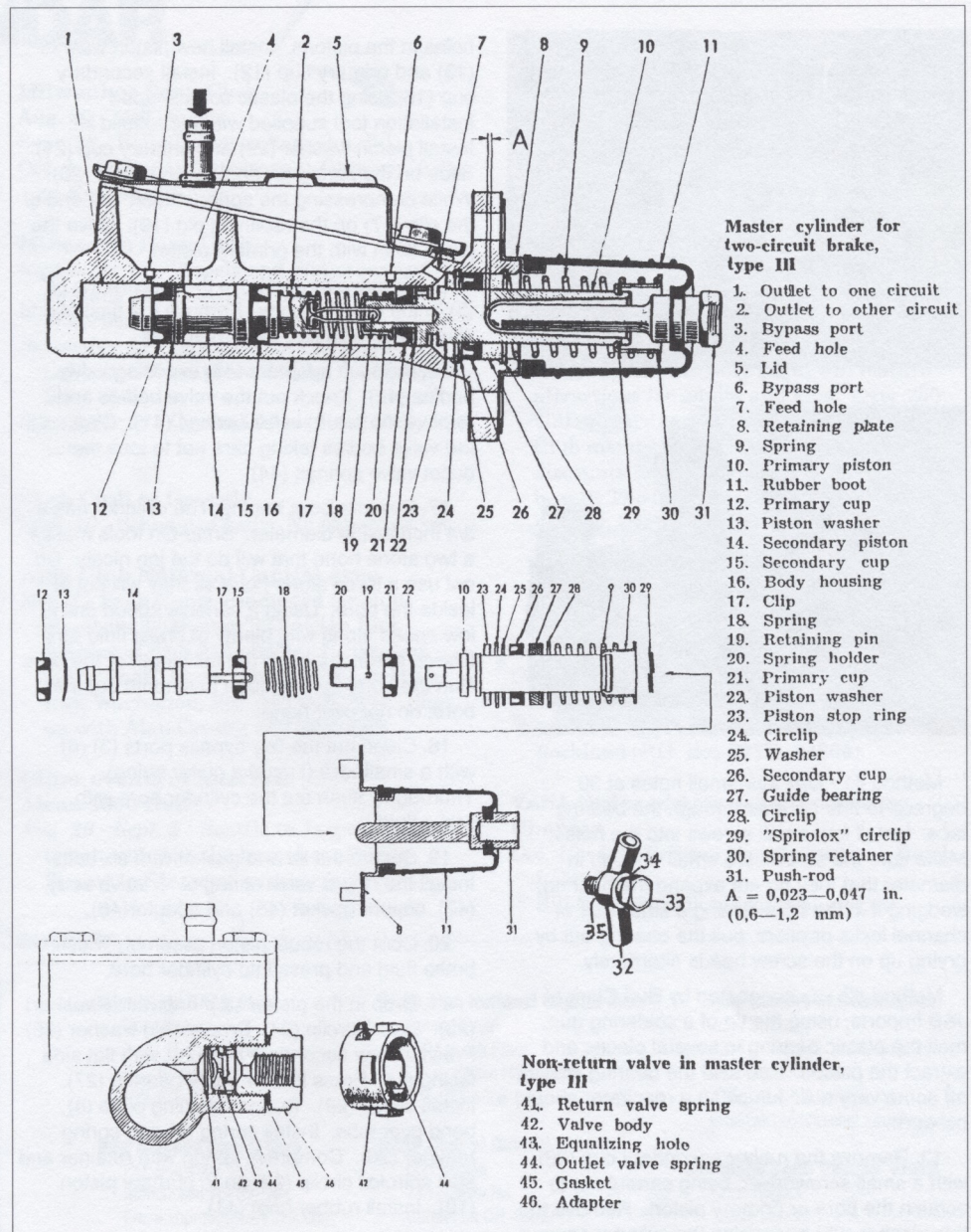

4. Remove the two banjo screws that secure the banjo fittings to the cylinder body (33).

5. Remove the two nuts that secure the cylinder to the firewall. One is located in the engine compartment and the other in the passenger compartment.

6. Remove the master cylinder from the car. Note: clutch master cylinder removal will make the preceding steps much easier as it blocks access to the brake master cylinder. Remove the banjo fittings (32) by loosening the brake line fittings the rest of the way (note the positioning of the banjo fittings).

7. Blow compressed air through the steel brake lines while opening one brake fluid bleeder at a time.

8. Clean out any dirt that is stuck in the threaded ends of the banjo fittings. Reattach banjos to steel brake lines but do not fully tighten. Tape the hole in the center of the banjos closed and tighten all bleeders.

9. Remove rubber boot (11), push down on

spring retainer (30) and remove spirolox circlip (29). The spring can be held in the compressed position by clamping a large vise grip on the edge of the cylinders mounting flange and the edge of the spring retainer. Separate the edge of the spirolox circlip with a small screwdriver, then spin off.

10. Bend out the four tabs on the retaining plate (8) and remove.

11. Remove circlip (28) exposing the white plastic guide bearing (27).

12. Guide bearing removal: Before attempting to remove the guide bearing you must clean away any dirt or rust that has collected in front of the bearing. I used a Dremel tool equipped with a tiny wire wheel, but sandpaper should suffice. Damaging the guide bearing is not an issue since it is included in the rebuild kit. Damaging the now-discontinued primary piston (10) should be your major concern. Wrap the piston with a little electrical tape to provide some protection during the next steps. Bearing removal can be accomplished in at least two ways.



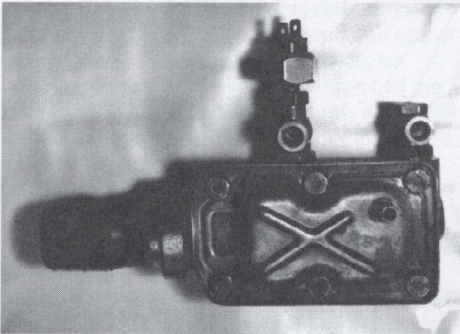
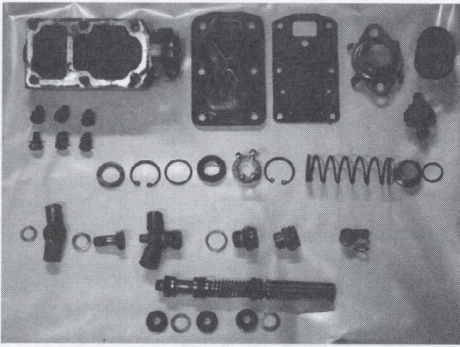

Method #1 - Drill four small holes at 90 degrees to one another through the bearing face. Install four small screws into the holes. Make sure the screws are small enough in diameter that they do not expand the bearing, wedging it in the bore. Using a small pair of channel locks or pliers, pull the bearing out by prying up on the screw heads alternately.

Method #2 - as suggested by Bud Clark of J&B Imports: using the tip of a soldering gun, melt the plastic bearing in several places and extract the pieces. Bud said the bearing will give off some very toxic fumes so a respirator should be worn.

13. Remove the rubber secondary cup (26) with a small screwdriver, being careful not to scratch the bore or primary piston. Remove the thin washer (25) by tapping the cylinder on your work bench. Remove circlip (24). Remove piston stop ring (thick washer) (23) by tapping the cylinder on your workbench. Pull the piston assembly out of the bore.

14. Piston assembly rebuilding: Compress the spring holder (20) and spring (18) to expose the retaining pin (19). Place a small nail between the spring holder and piston (10) to hold the spring back while working on the retaining pin. Using a suitable punch, tap the retaining pin out of the cylinder just far enough to allow the clip (17) to be "unhooked" from the retaining pin. Do not drive the pin out completely. This is one of those moments when pieces are waiting to go flying all over the place. While holding back the spring (18), separate the secondary piston from the primary piston. Remove the three rubber cups (12) (15) (21) noting their direction. Remove the two piston washers (13) (22). If the retaining pin (19) is correctly positioned you can remove and replace cup (21) and washer (13) over it. Clean all parts thoroughly with brake fluid taking special care to clean out the small

holes in the pistons. Install new piston washer (13) and primary cup (12). Install secondary cup (15) using the plastic cone shaped installation tool supplied with the rebuild kit. Install piston washer (22) and primary cup (21). Slide on the spring (9) and spring holder (20). While compressing the spring, "hook" the end of the clip (17) on the retaining pin (19). Drive the pin in flush with the primary piston.

15. Remove the six bolts that secure the lid (5) to the cylinder body. Remove the gasket and clean out the lid and fluid chambers.

16. Remove adapters (46) exposing valve bodies (42). Knock out the valve bodies and remove the return valve springs (41). Clean out the valve bodies taking care not to lose the outlet valve springs (44).

17. Cylinder bore honing: The cylinder has a 3/4 inch inside diameter. Snap-On tools makes a two stone hone that will do the job nicely. Do not use a three stone hone as they will not fit inside the bore. Using a variable speed drill at low speed along with plenty of brake fluid as a lubricant, run the hone the full length of the bore. Run the hone long enough to smooth out the bore, do not over hone.

18. Clean out the tiny bypass ports (3) (6) with a small wire (I used a guitar string). Thoroughly flush out the cylinder bore with brake fluid.

19. Secure the lid and gasket with six bolts. Install the return valve spring (41), valve body (42), copper gasket (45) and adapter (46).

20. Coat the rebuilt piston assembly with brake fluid and press into cylinder bore.

21. Drop in the piston stop ring (thick washer) (23). Install circlip (24). Drop in thin washer (25). Press in new secondary cup (26) with flat side facing out. Press in new guide bearing (27), install circlip (28). Put on retaining plate (8), bend over tabs. Install spring (9) and spring retainer (30). Compress spring with retainer and spin spirolox circlip (29) on to primary piston (10). Install rubber boot (11).

22. Apply grease to push rod (31). Reattach master cylinder to firewall.

Fasten master cylinder to banjo fittings with banjo screws (33). Don't forget copper washers (34) (35). Retighten steel brake lines to banjo fittings, attach brake light switch. Connect rubber hose to cylinder lid if so equipped. Fill system with brake fluid and bleed.

Just before writing this article I rebuilt three Sonett brake master cylinders that were laying in my shed for several years. During the rebuilds I discovered that condensation was attacking the cylinder bores while they sat in storage. Had I waited another couple of years the cylinders would have required resleeving.

The most important part of the rebuild is protecting the primary piston from scratches while removing the dreaded plastic guide bearing. If you have patience and take safeguards to catch the inevitable spring loaded projectiles, this job is not as difficult as it sounds.

## Rebuilding a C900 front end

This is the long promised report on the broken axle and complete rebuild of the front end of my grey 1986 900S. The inner tripod on the right side axle started chewing itself up on a weekend road trip. Smoke was coming from what was left of the inner boot, but I was able to limp home, (at all of 70mph). After seeing the condition of the axle after I took it apart, I'm sure that another car would have quit right then and there, mandating an expensive tow home. The bearings had separated from the tripod entirely, leaving only the metal stubs on the tripod. Of the stubs, the metal had worn itself from circles to ovals.

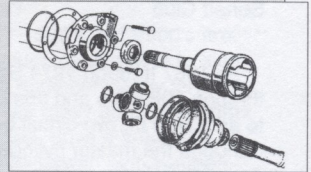

Because the inner driver was heating up tremendously, I took the opportunity to stop at every winery on the way home, threw water on the inner driver and let it cool while I kept tasting.

I took this opportunity to upgrade the car's non-Turbo single non-ventilated brake discs to the ventilated Turbo versions, as well as the larger inner drivers and Tripods. This required new calipers and hubs, and I installed new outer c/v joints as well. An entirely new front end is expensive but it's like getting a new car without paying interest on a car loan.

Also, my 900 can carry more than most pickup trucks, as well as tow more weight. So I don't need to buy a Sport Utility Vehicle as many people do, because most passenger cars are useless for transporting stuff and towing racecars.

Townsend Imports (Ywan Mason) was extremely helpful with matching up parts for me. Because there were slightly different clearances between hubs, calipers and discs between the different model years, ordering and matching parts is a tricky process. He installed wheel bearings and new hubs in a pair of extra steering knuckles, so that with his instructions, all I had to do was take the old parts off the car and bolt the new ones on. I worked slowly and it took the better part of a day. The car now feels tight and precise when I drive it, and is now ready to go another 150k without stopping.

Townsend's prices were great and they can get any 900 part at well below what I used to pay. Consider this a strong recommendation! You can reach them at [ymason@bellsouth.net](mailto:ymason@bellsouth.net) or 910-292-4170.

A final note, this inner universal joint problem was not a surprise. It began as a rumbling and shuddering on hard acceleration. I began to buy the parts and thought it would last a little while longer, at least until after that fateful weekend... in general, wiggly suspensions should definitely get more attention than I have given them.

**Rob Wagner**  
New York

*PS. Ywan also fixed (in about three minutes) the long standing problem of the hatch bouncing open whenever I go over one of those ubiquitous Texas Speed Bumps.... I'm now noticing little things about the car like the squeaks, thunks and jiggles, so life must be good!*



# CLUBS CALENDAR

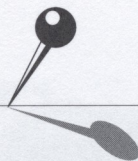

## Heart of America SAAB Convention

Sept. 17-20

Holiday Inn Convention Center, Austin, Minnesota and Meyer Garage, Meyer, Iowa. The schedule has been set. Registration begins at 6:00 pm at the Holiday Inn Convention Center, Austin, MN, on the 17th and continues the following morning at 8:00 am. Workshops, tech sessions, swap meet, rally, autocross, and banquet take place in and between Austin and McIntire, Iowa (about 20 miles apart). Contact Jim Iverson at 319-364-4015 (Email: [finasco@mccloudusa.net](mailto:finasco@mccloudusa.net)) or Marty & Annette Adams at 515-737-2239 (Email: [info@meyersaab.com](mailto:info@meyersaab.com)). Must pre-register by Aug. 15.

## California Saab Camp Out

Sept. 19-20

For the 3rd year Turbo! is sponsoring the California Saab Camp Out, in the Santa Ynez Valley about 15 minutes north of Santa Barbara. We'll go to Danish Days on Saturday and the Ren Faire on Sunday, and we're planning to have a slide show on Saturday night. Reserve in advance so we have enough campground space. To get the flavor of what it's like check out the Turbo! web site under the events section: <http://secret-secret.com/turbo/>. Rob Lodes, 415/333-5974.

## Milwaukee Saab Club

Aug. 30 - MSC Picnic.

Sept. 28 - Belle Dodge in Kenosha, WI.

Oct. 4 - Saturday Autocross at Gateway Tech in Kenosha, WI.

## Minnesota Saab Club

September 12 - Wheels and Wings car and airplane show, Osceola, WI. Presented by Motorbooks International.

September 12 - Linden Hills Car Show/Collection Tour, presented by the Mercedes-Benz Club.

September 26 - Coulee Classic Road Rally and Tour.

## Saab Club of Georgia

Sept. 20 - Scheduled rally. No details as yet.

## Saab Club National Capital Area

Nov. 7 - Saab Clinic, conducted for club members by Master Technician Rick Stanley of S&S Auto Sales. Bring your ailing Saab, 10am - 4pm, 5009 Lee Highway, Warrenton, VA. 540-349-2744. Sign up with Alan Crosby, 540-522-4008.

## Other events of interest:

### Alcan 5000 Rally

Aug. 29 - Sept. 5 - Seattle to Jasper: Alcan teams will take the ferry from Prince Rupert to Skagway, with stops in

Ketchikan, Wrangell, Petersburg, Juneau, and Haines. The route travels to Dawson City with a side trip up the Dempster Highway to the Arctic Circle. Inquiries: Alcan 5000 Rally, 13 Central Way #300, Kirkland, WA 98033; ph. 425-823-6343; Internet: [www.alcan5000.com](http://www.alcan5000.com)

## The Children's Museum of Indianapolis Vintage Grand Prix ShowCar ShowDown

Oct. 3-4 - Third annual event, held at Indianapolis Raceway Park, will feature attractions for adults and kids. Over 250 vintage race cars compete and show. Saab Club members eligible for substantial discounts for pre-registering. All proceeds benefit The Children's Museum of Indianapolis, IN. Contact David Wood, c/o The Children's Museum, P.O. Box 3000, Indianapolis, IN 46206-3000, ph. 317-921-4139 extension 1050.

## Owl's Head Transportation Museum

Oct. 4 - Foreign Auto Oktoberfest. Live Oompah band, antique aircraft, flying exhibits. Owl's Head, Maine, just south of Rockland (P.O. Box 277D, 04854).

## VASA Order of America, New Jersey Chapter

Oct. 10 - Leif Erikson Parade/Festival, Budd Lake, NJ.  
Bill Sohl, E-mail: [billsohl@planet.net](mailto:billsohl@planet.net)

## North American Saab Clubs & Contacts

### Appalachian SAAB Club

Ken Edwards  
296 Brethren Church Rd.  
Jonesboro TN 37659  
423-753-3153

### Bay Area SAAB Club

(Northern California)

Douglas Morse  
25291 Morse Ct.  
Hayward CA 94542  
510-582-1858  
Email: [saab\\_club@prodigy.com](mailto:saab_club@prodigy.com)

### Carolinas Saab Register

Jason Henske  
2830 16th St. NE Apt. #99  
Hickory NC 28601  
704-256-9211  
Email: [NCSaabreg@AOL.com](mailto:NCSaabreg@AOL.com)

### Central Penn SAAB Club

George Basehore  
477 E. Main St.  
Middletown PA 17057  
717-944-2915

### Delaware Valley SAAB Club

Pat Bolmeyer  
1311 Clifford Rd., Oak Hill  
Wilmington DE 19805  
302-994-2173

### Gateway City Saab Club

Greg Cassidy  
62 E. Adams Dr.  
Cahokia IL 62206  
(618) 320-5330

### Great Lakes SAAB Club

(Western Michigan)

Jim Laman  
617 Beechwood  
Holland MI 49423  
616-335-5215  
Email: [lamanjim@juno.com](mailto:lamanjim@juno.com)

### Green Mountain SAAB Club

(Vermont)

Cathleen Pembroke  
RFD #5, Box 2758  
Montpelier VT 05602-8812  
802-476-7994  
Email: [sbprods@earthlink.net](mailto:sbprods@earthlink.net)

### Gulf Coast SAAB Club

Ron Hernandez  
2422 Killdeer St.  
New Orleans LA 70122-4316  
504-283-0822  
Email: [rthrnandz@AOL.com](mailto:rthrnandz@AOL.com)

### Milwaukee SAAB Club

Andy Saksa  
2480 Eastwood Ln.  
Brookfield WI 53005  
414-785-1550

### Minnesota SAAB Club

Dean Nelson  
1420 15 Terrace NW  
New Brighton MN 55112  
612-636-3771

### New England Sonett Club

P.O. Box 4362  
Manchester NH 03108  
Email: [sbprods@earthlink.com](mailto:sbprods@earthlink.com)

### New Jersey Saab Club

Bob Adams  
448 Old Deal Rd.  
Eatontown NJ 07724  
908-544-0516

### Northwest SAAB Owners

(Washington, Oregon, British Columbia)

Skip Schott  
20220 80th Ave. SE  
Snohomish WA 98290  
425-486-1351

### Rocky Mountain SAAB Club

(Colorado)

Jerry Danner  
519 Lipan St.  
Denver CO 80204  
303-595-4646

### SAAB Club National Capital Area

Donald Titus  
3504 Hutch Place  
Chevy Chase MD 20815  
301-652-6806

### SAAB Club of Central Ohio

Dan Orzano  
2434 Dover Rd.  
Columbus OH 43209  
614-231-3892  
Email: [dorzano@compuserve.com](mailto:dorzano@compuserve.com)

### SAAB Club of Georgia

Chris McPherson  
915 Franklin Goldmine Rd.  
Cumming GA30040  
770-844-5961

### SAAB Club of Iowa

James Iverson  
P.O. Box 2329  
Cedar Rapids IA 52406-2329  
319-364-4015

### SAAB Club of NE Pennsylvania

Ron Augelli  
1723 Clearview St.  
Scranton PA 18508  
717-969-9863

### SAAB Club of Texas

Craig Bobchin  
Suite 100-165  
12407 N. Mopac Express  
Austin TX 78758

### Saab Owners of Canada, Inc.

John S. Casey  
4214 Dundas St. West, Suite 106  
Etobicoke ONT M8X 1Y6  
416-239-6228 voice & fax  
Email: [ak146@treenet.toronto.on.ca](mailto:ak146@treenet.toronto.on.ca)

### San Diego SAAB Owners' Group

Chris Rogers  
10559 Lansford Lane  
San Diego CA 92126-  
619-530-0019  
Fax: 619-530-0096  
Email: [annexus@abac.com](mailto:annexus@abac.com)

### Southern California SAAB Club

Paul Florance  
126 1/2 Main St.  
Seal Beach CA 90740  
310-493-6707

### Tristate SAAB Club

(Ohio, Kentucky, Indiana)  
Paul Arel  
9864 Baughman Rd.  
Harrison OH 45030-1771  
513-367-9864

### Utah SAAB Club

Chris Cox  
P.O. Box 526105  
Salt Lake City UT 84152-6105

### Western Pennsylvania Saab Club

Andy Bittenbinder  
9433 Katherine Drive  
Alison Park PA 15101



# Saab NEWS...

## 9-5 Reviews

### Living with a 9-5

First report - Day 13

I recently took possession of a 1999 Imola Red, 4 cylinder, 5 speed Saab 9-5. What a car! Miles ahead of my old 1990 9000 Turbo 5 speed.

On deciding on a replacement for my 1988 900 convertible, the dealer had available a 1998 9000 Special Edition. I test drove this model as well as the 9-5 and the difference was immediately apparent. The ride, handling, smoothness and quiet of the 9-5 were all superior to that of the 9000. The Saab quality is all there. Or is it?

This is my first experience with a new car, my other four Saabs and other models all being bought used. I was not overly worried in purchasing the first year of a new model as I was relying on the Saab reputation of quality engineering and testing. But so far after 13 days of ownership, two major faults have occurred.



1. On day 8 while driving, I lost all power steering. I was not too re-assured when upon calling the Saab Roadside Assistance I was met with, "A what???", when I told the operator what model of car I had. As it turned out, a hose coupling to the power steering pump had come loose, spilling fluid. The coupling was tightened, fluid replaced and the next day I was on my way. Downtime was a half a day and a trip to the dealer.

2. At the same time as the power steering problem, the display panel announced "Service theft alarm". The "chirping sound" heard when activating and de-activating the alarm and door locks had disappeared. Yesterday, after another trip to the dealer, this problem has been diagnosed as a faulty siren. The siren is on order

and will require another trip to the dealer for the replacement.

As you can imagine, my confidence in the reliability of the 9-5 has taken a sharp downturn. I write this message to inform other owners and potential purchasers that this car is not exactly problem-free! If anyone out there is a 9-5 owner, let's discuss any problems you may have encountered.

### 2nd report - Day 22

Thumbs up:

- \* very smooth, quiet and powerful;
- \* the car just pulls and pulls. At 180 kph she will still accelerate (don't ask how I know!);
- \* sound system is excellent;
- \* trunk seems as large as my 9000;

Thumbs down:

\* after a visit to the dealer for the power steering leaking problem, which was fixed, yesterday I decided to check the level after my wife noticed a puddle under the front of the car. Sure enough, the reservoir was nearly empty. So obviously the problem is still there. So it's back to the dealer again today (third time for those of you keeping track). They found a disintegrated washer in one of the fluid lines. It has now been replaced and let's keep our fingers crossed. By the way, the dealer, Saturn Saab Isuzu of Brossard, have really done a great job in helping me out.

You know, one of the reasons I bought a new car was so that I could stop playing mechanic and having to monitor and change fluids myself. Well, I guess that won't happen with this Saab. Too bad Saab do not advertise the same 30 day money back guarantee as Saturn here in Canada. I might be inclined to take them up on the offer.

My son, Jay and I had the opportunity to drive a new 9-5 at our last SAAB Club of Iowa meeting held at Meyer Garage in McIntire, IA. Marty Adams made his demonstrator available for the test drive and we "put it through the paces". Once seated and strapped in, we looked over the controls to familiarize ourselves with the layout. It is very pleasing. It still shows signs of being "Americanized" but that seems to be the trend with SAAB these days. I am still a 900T person and even though I have owned 9000's, they don't suit my driving style or looks. The 9-5 is more appealing than the 9000.

Performance wise, I'm sure the 9-5 would out perform the 900. The max torque curve comes

### 3rd report - Day 60

We just got back from a vacation on Cape Cod. In 17 days of travelling, we saw only 2 9-5s. The car performed admirably. There still seems to be one small bug. The clock and date has reset itself twice to Jan . 1 and 0:00 hours. Don't know why. Hope it is not some Y2K bug!!!!

I now have 4,000 km. on the odometer. There is however not enough storage space inside the cabin, certainly not as much as my 9000. And is it ever sorely missed! The door side pockets are really too small for maps and guides. The glove box is also small and oddly shaped and the owner's manual portfolio takes up much of that space. On the other hand, the chilled glove box really works; 32 degree C (90F) weather and our chocolate bars were nice and firm. Stuck in Boston traffic for over 90 minutes in 32-33 degree C (90+F) weather and the temp gauge never moved from the center of the dial. I did find the AC a little slow after stopping the car for a while and then getting back in.

Our back-up key and fob were run over on the highway but still work. ( I left my key on the roof of the car and my wife used her key to drive off). Trunk is enormous - 'bout the same as my 9000. I do like the cargo net and would recommend another one across the rear of the trunk to hold things in while you close the lid. So, I guess you could say I am HAPPY with my 9-5 (understatement, really).

**Bob Dupuis**

Montreal, Quebec  
email: krdupuis@total.net

much sooner and stays longer than the 900SE Turbo. It doesn't have the "rush" of the old turbo but that is deceptive. It is so smooth. That smoothness stays with you all the way up to excessive speed... REAL EXCESSIVE SPEED! I would guess the American public will like it because of the "Americanization" that has taken place with this latest design. I for one would like to see the 900 — now 9-3 — hang on for a number of years and even regress back to a stripped down sans auto heat/ac, manual windows, etc. We've become spoiled!

**Jim Iverson**  
Cedar Rapids, IA



# Saab News... edited by Seth Benglesdorf

I had the opportunity to test drive two 1999 Saab 9-5s in February during preparations for the North American media ride-and-drive in Catalina, Arizona. Based on some fairly brief drives, here is what I found:

The base 9-5 with the 2.3 LPT and 5 speed manual is a very nicely balanced car which maintains the "agility" in chassis performance of previous Saabs and at the same time provides much improved ride comfort over the 9000. I took the opportunity to "fling" it around a little and found it very forgiving and predictable with the expected great road feedback. The 9-5 also gives the feeling of being an extremely stable car, no doubt due to the improvements in chassis rigidity and the addition of independent rear suspension. In all, from a comfort and visual point of view, the 9-5 is a big car, but it doesn't feel that way from the driver's seat - the Saab "feel" is intact! The engine provides good performance with plenty of torque from 1800 rpm on up; there's no noticeable torque steer.

The V6 9-5 SE includes all the goodies, but unfortunately forces the automatic transmission. The car has the basic chassis goodness of the 2.3 version, but is perhaps a bit less crisp in the handling department - maybe due to the additional weight of the engine/transmission combo. The V6 is, however, a mother lode of torque which leaves you with the feeling of a very fast car - perhaps faster than it really is. As for the much ballyhooed ventilated front seats, I admit it wasn't either hot or cold during my drive, but I found the noise of the fans to be pretty annoying.

I also had the opportunity to attend the 9-5 Dealer introduction in Palm Springs where the 9-5 pricing was announced. The "introductory price" on the 2.3L LPT with manual transmission is \$29,995.00 which is lower than anticipated judging from the positive reaction of the dealer group. In visiting a number of dealers since then, I have seen a number of cars with the \$29,995.00 sticker price, which is nice to see. If one adds options like Automatic Transmission, Sunroof, and Heated seats, the price moves up to the upper \$32K range. The V-6 powered 9-5 SE which I think is intended to appeal more to people who haven't previously owned Saabs will weigh in at \$36,995 when it goes on sale later this year; I believe it includes almost all of the things that are optional on the other models. Kudos to Saab for keeping a model in the line with cloth seats and a manual trans; when the Wagon becomes available I'm really going to start eyeing my checkbook!

Gary Stottler  
via email



## News on the 9-5 Wagon

Saab has released photos of their new 9-5 Wagon, set to debut next year. The wagon comes complete with such equipment as load fixation tracks in the cargo-area floor, a removable rear parcel shelf, roof rails, cargo-area illumination and an optional sliding floor to facilitate loading and unloading. A third-row rearward facing seat is also available to make the 9-5 a seven-passenger wagon. The rear seats can be folded to further expand the generous cargo capacity.

The exterior of the Wagon is distinguished by the same classic Saab design features as the 9-5 sedan - the wedge-shaped body, curved windshield, clamshell hood and sleek grille that reflects Saab's aircraft heritage. Styling is highlighted by the rear design, where the sweeping C-pillar is emphasized, the rear window is raked forward and the rear roof pillars are blacked out, creating the impression that the glass wraps fully around the back. Like the 9-5 sedan, an all-turbo Saab Ecopower engine range powers the 9-5 Wagon.

Still no word, however, on whether AWD will be available on the 9-5 models.

The Saab 9-5 Wagon will debut at the Paris Motor Show in September. In the North American market, deliveries are expected to start in the spring of 1999.



## 9-5 V6 not here yet

The much talked about asymmetrical 3.0-liter V6 in the 9-5 has not been released in the U.S. Latest estimate is October, 1998 for the 200 hp engine derivative.

## Two Saabs Named "Top Cars" by

Consumer Review  
Both the Saab 9-5 and Saab 9-3 have been named

among the best cars sold in America, according to Consumer Review magazine. Editors selected the Saab 9-3 Coupe, five-door and Convertible and the new Saab 9-5 performance sedan for inclusion in the annual guide, "Consumer Review Top 40 New Cars". After evaluating more than 200 new car models, Consumer Review selected ten top cars in each of four categories: Luxury/Sports Sedans, Family Cars, Sports Coupe/Convertible and Bargain Cars. The Saab 9-5 line was selected

as one of its Top 10 Luxury/Sports Sedans, while the Saab 9-3 models were honored in the Top 10 Family Cars category.

Describing the Saab 9-5, editors reported, "The 9-5 provides an over-the-road feeling of considerable refinement. It is the type of car that endears itself to its occupants more each mile, making it particularly well suited to long drives."

Talking about the Saab 9-3 five-door and Coupe, editors wrote, "Nearly all the luxury features come standard at a reasonable price. This much alone is tough to find in a European or Japanese car costing under \$30,000. Yet Saab does this beginning in the mid-\$20,000 arena." The review tags the Saab 9-3 Convertible as "the champion 4-seat ragtop on the marketplace today."

## Saab Opens Interactive Showroom

Saab Cars USA, Inc. has opened the doors to its all-new Interactive Showroom, located at [www.saabusa.com](http://www.saabusa.com). Modeled after the architectural design for new Saab retail facilities, the Saab Interactive Showroom duplicates a real-life dealership environment. Inside the front doors, customers find a comprehensive shopping experience, from a video showcase of safety, performance and heritage segments, and a gallery of Saab innovations, to a Java-based "Build Your Own Saab" function that automatically generates a virtual window sticker complete with options and pricing information. Near the product area, Saab enthusiasts can choose to watch one of six informative video segments on the Video Showcase. The safety, performance and Saab heritage segments are shown courtesy of RealMedia streaming technology. The result is superior quality streaming video, which can be viewed without lengthy download times.

The car display is the centerpiece of Saab's Interactive Showroom. Here customers can specify the Saab 9-5 or Saab 9-3 variant of their choice with exterior color and wheel choices. Once a car is customized, and additional available options are selected, the Java program can dynamically generate a virtual window sticker, and the appropriate manufacturer's suggested retail price (MSRP). Then, with the click of a button, the shopper has the choice of sending the car specifications and customer contact information to a local Saab dealer. The virtual window sticker can also be printed out for comparison shopping purposes.

Saab also invites visitors to step into the driver's seat of a Saab 9-5 and Saab 9-3-online. Using technology developed by Oak Ridge, Tennessee-based International Pictures Corp., (IPIX), customers can take a 360-degree interior tour of each Saab, while seeing the virtual showroom outside the windows. Each interior tour includes a number of a "hot spots" that a customer can zoom in on, such as the Weather Band button or Wide Angle Passenger Mirror.

Historic... to page 32



# It's About Image

By Len Lonnegren

*Len Lonnegren was the head of public relations for Saab's U.S. distributor from 1963 to 1989.*



When Saab AB – the now independent aircraft corporation – turned 60 years old last September, the company logo was slightly changed: Although it looks the same as before, with the crowned Griffin head and the elliptical surrounds, which are supposed to symbolize Saab's aircraft and space technology, the word "Aerospace" has replaced "Scania".

When announcing the Saab AB logo change, Saab Automobile stated that "there are no concrete plans" to change the Saab Automobile logo. But I would guess that some kind of change will soon come: There is no connection whatsoever between Saab and Scania any longer, so why maintain "Scania"... and Scania AB changed their logotype several years ago to eliminate "Saab".

We must hope, though, the when and if there are any changes made the basic logo-

type will remain pretty much as it is today. The "Saab Chicken" has only been around for 13 or so years now, but it is a logotype that somehow managed to give the company an almost instant heritage. And it came about pretty quickly...

I think it was sometime in 1983 when I, along with many others from different countries and parts of the company were called to a meeting in Sweden, to discuss how we could better utilize our very different corporate backgrounds and images. The general feeling at the meeting was that Saab-Scania had to have a symbol, that could be used by all its entities.

Two days later I went to lunch in Stockholm with the corporate PR and advertising honcho, executive vice president Kai Hammerich, and a well known Swedish artist, Carl-Fredrik Reutersward, to talk about sponsorship of an upcoming show of his art in Los Angeles. In passing Hammerich asked if Reutersward had some ideas on what a Saab symbol should look like.... With that the ball got rolling.

Many others in the company, notably I remember Saab's chief stylist Bjorn Envall, came up with ideas for symbols. But Hammerich prevailed, and Reutersward's quickly developed logo gave Saab-Scania the "instant heritage" it so needed. While the circles are supposed to symbolize the aircraft side, the automobile was sort of left out, because the logo's most important feature is the head of the Griffin, a mythological creature, which, according to the artist, in Greek mythology stands for the sun, the arch of heavens and the golden light of dawn... and the Griffin is also part of the seal of Sweden's southernmost province of Skane – Scania in Latin. The Griffin was actually used already on the very first Scania vehicle in 1901, and is still a major part of the Scania logotype, although since a few years back the surround for that logo has been altered.

The Saab-Scania logotype was, and remains, important. For the first time in many years it gave the company a real,

not. But reading *The Saab-Scania Story*, the book published in connection with Saab's 50<sup>th</sup> Anniversary, I found a not very good picture of an old brass plaque, with what looks like the "airplane logos". The aircraft doesn't look exactly like the one used later, but it does show a resemblance to a twin-engine aircraft that was actually built by Svenska Aeroplan Aktiebolaget as early as 1938. It was a bomber, with the Swedish Air Force designation B-3, that was built under license by SAAB in 102 copies. It was much better known abroad as the Junkers JU 86K, a medium weight bomber that made up a large part of Nazi Germany's bomber fleet in the early part of World War II.

Later in the same book there is a picture of what is called "Saab's new corporate symbol", on the pages that report the company's 1964 name change from Svenska Aeroplan Aktiebolaget to Saab AB.

The aircraft logo was around for quite some time, both before and after the name change, and was even on the Saab 99, but then it disappeared. My friend GAS – Gunnar Sjogren – who wrote and illustrated the definitive books on Saab car products, *The First Million* and *The Saab Way*, also used to fool around with Saab logos. I believe he was the one who came up with the solid lettering SAAB, with connected letters, which of course is still being used – both in the Griffin logo and separately. For awhile he also fooled around with an idea for a circular logo with the letters SAAB over and over, reading, I believe from the outside in, with all the "B's" meeting in the center.

A logotype is an important part of corporate image building. In Saab's case the "Chicken" has become closely associated with Saab automobiles, and with the company's high tech heritage. Maybe the word "Scania" doesn't belong in the logo any more, but it sure would be a shame to change it too much, or to take it away altogether....



uniform symbol. It has been seen world wide on Saab aircraft and cars, and on Scania trucks and buses. It would be a shame to abandon it...

Most old-time Saab car fans I know, though, would seem to favor a much older symbol, the one with the tall, narrow letters SAAB, and a twin-engine propeller aircraft of a type not generally associated with Saab. After all, the only Saab twin engine aircraft were the 340 and the newer 2000 commuters, and the World War II B-18 bomber, which, however, had its cockpit offset to one side, which the logotype aircraft does





# GOLDWING

## USED SAAB PARTS WAREHOUSE

### Nationwide Shipping UPS - COD

Alternators  
Starters  
Axles  
Calipers  
Antennas  
Radios  
Wheels  
Tires  
Tail lights  
Window Motors  
Rack & Pinions



Transmissions  
Engines  
Radiators  
Grilles  
Fenders  
Turbos  
Bumpers  
Air Compressors  
Cylinder Heads  
Seats

**All parts Tested and Guaranteed, some Lifetime!**  
**Over 75,000 Used Parts In Stock**  
**We Specialize in 900 and 9000 Only**  
**Call 1-800-SAAB137 or (315) 625-7969**  
**Rt. 11 Hastings NY 13076**

#### Klinik from page 17

I am a fourteen-going-on-fifteen year old who comes from an avid Saab family. We have had four Saabs since 1982 and currently own three. My car is a 1986 9000 Turbo 5 speed. It has 175,000 miles on it, and is mechanically sound.

My question has to do with the Electric Display Unit, which is not working right. The display still works, but it is in the metric system, and the R and INFO buttons have no effect on it. I have noticed that the R and INFO buttons and the clock are all lit up at night in our other 9000 but will not light up in my car. Is there a loose connector going into this control, or do I need a whole new unit? Can I fix it myself?

Another question I have is about wheels. I would love to locate a used set of the three spoke 16" wheels that made their debut on the 1991 9000 Turbo. Do you know where I could find a nice used set of these?

**Jared Kuehn**  
Missoula, MT

*To change your EDU from metric to standard, press the 'R' and the 'info' button at the same time, and hold them down for at least 15 seconds. The bulb in your trip computer control is serviceable and common. To replace the bulb requires removal of the top of the dash and the instrument cluster.*

*On the issue of the 16 inch wheels, 1986 9000 was designed to have with 15 inch wheels. Also note that*

*the 16 inch tires there is a limited choice and cost more to purchase. If you must go that route, however, check with some of the used parts suppliers who advertise in this fine publication!*

I would like to know if there is any way of better accommodating tall drivers in the Saab 900s. The top of my head brushes the ceiling and outward visibility is impaired. We currently have a 1996 SE Turbo with power seats, but our previous Saabs, a 1995 S with manual seats was the same, and our 1987 9000 Turbo was worse.

Our dealer said a thinner seat cushion is available for the 9000, but he knew of nothing for the 900s. My wife is 5'1" and finds the lowest seat position just right, so if we could lower the position a couple of inches, she could use the height adjuster for a raised position.

**Bill Hamilton**  
Tracy, CA

*Saab's seats have a wider than average range of adjustment but your case sounds exceptional. It may be advisable to seek an alternate seat manufacturer, such as Recaro. It would definitely be expensive but these seats are very well made and may help you solve your problem.*

I am very pleased with my '91 9000 Turbo (67k, manual transmission). My right rear power window motor seems to have an intermittent mind of its own. The motor runs while the window does nothing, without touching the button. Car running, key on, doesn't matter. It will go away for days then return.

**Michael Higgins**  
Idaho Falls, ID

*It sounds like either the switch in the console is shorting out (perhaps an overturned drink?), or your car is demonically possessed. Unfortunately, at this time we have no information on factory-authorized exorcisms.*

On the 1996 9000 CSE 2.3 Turbo, is the bolt that holds the serpentine belt tensioner pulley a left or right hand thread (does it tighten clockwise or counter-clockwise)?

**Joseph H. Jessen**  
New York, NY

*The bolt is a left hand thread (clockwise to loosen)*

Send questions about Saab repair to: Saab Klinik, 7675 Bear Trap Jct., Saginaw, MN 55779. Or send email message to: DrNio@saabclub.com.



# 25 Years. Or is it 27? Or 24?

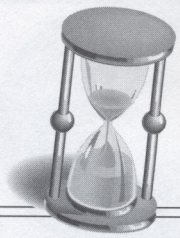

**The early history of the Saab Club of North America is rather vague and spans several years, so it's difficult to celebrate the beginnings.** The current magazine, NINES, grew out of the newsletter of the Chicago Saab Club, which began 25 years ago. But it wasn't until 1974 that the "Club" went national.

The Chicago Saab Club actually started in 1971, and there may have been an earlier newsletter, but "Issue No. 1" of UP FRONT is dated March, 1973. The name refers to front-wheel drive, at that time still a rarity for most manufacturers. Allyn Reilly was listed as the return address on the first issue, but much of the work was done by Dick Grossman, a semi-retired graphic artist.

Grossman went on to become known as the first editor of *The Saab Club Newsletter*, and founder of The Saab Club of North America. For over seven years, he and his wife Ruth would crank out an 8 to 12 page newsletter every month from their Chicago apartment, doing all of the layout, folding and mailing of each issue.

Beginning with issue #17 in July, 1974, Grossman tried to expand on the growing popularity for FWD, as the banner atop the first page read "Compact Front Wheel Drive Club of America," and later added the legend "Dedicated to

Small Engine, Small Cars & Energy Conservation." While the primary topic was still Saabs, other makes such as Honda, Renault and Volkswagen were often included in the tech tips. At about the same time, he began advertising the newsletter in *Road & Track* magazine under their "Clubs" section in the classifieds. (R&T used to offer clubs a special rate which made it reasonable to advertise there. A few years ago, new ownership of R&T decided they weren't making any money off those ads so raised the price to the same as other ads.) Issue #17, all six pages of it, indicates 95 paid members, with an additional 20 issues sent to "local dealers and friends." Based on Grossman's comments in later issues, #17 appears to be the first effort at growing the club beyond Chicago, and established the basic format that lasted until May, 1988. By July of 1975, the membership was over 500 and still growing. The July, 1976 issue was the first to break 1,000 members.

Dick Grossman's legacy seems to be his vitriolic editorials, often titled "5 Minutes of Hate", in which he tore into General Motors and other auto manufacturers for putting profit ahead of safety and reliability, and at the numbskulls who bought such products based on advertising or price and not on the merits of the vehicle. Grossman was

forced to retire as editor when he suffered a series of heart attacks in 1980.

The newsletter was taken over by Jeff Delahorne, who moved the publication to his home in Duluth, Minnesota. Other than greater use of photos, little changed on the publication during the next five years. Delahorne remained editor until 1985 when he took a job with Saab-Scania of America. The newsletter followed Jeff to Connecticut while his wife, Carolanne Curtis, acted as interim editor for several months. Tim Winker took over the reigns officially with the January, 1986 issue and the publication moved back to Duluth.

A few months later, the newsletter was given the name NINES, because Winker felt that all publications of this sort needed a proper name. NINES was chosen because it was the first number in the model designation of all Saab cars, and it was something unique to Saab. Fortunately, Saab has decided to carry on that tradition with its latest models, the 9-3 and 9-5.

Over the ensuing years the 12-page newsletter evolved into the magazine you hold today, with more technical information, news, history and advertising aimed at Saab owners, organized by topics, and with columnists who share their knowledge of the Saab marque. ●

## Discourses from pg. 11

look after themselves and pay the consequences if they get involved in misadventures that are their own fault. In the Land of the Free, Home of the Brave, the first thing one does is look for a lawyer ... if the lawyer isn't standing there knocking on your door before you can get too it.

I respect the legal profession greatly, but I think the practice of tort law is way out of control... with serious consequences for each of us in our daily lives.

End of sermon.

## Cupholders

One Turbo! subscriber cynically commented:

"At some car show (I assume the NY show?) they were showing the latest models and how cupholders were the 'latest craze'. I think the 9-5 got 'best cupholder of the show.' There were 3 to 4 scenes of the 9-5 showing the cool dash cupholder... they also showed off the glove box fridge, too!

Has this become the focus of SAAB's marketing strategy? Peddling

cupholders and cold registration papers in the glove box? That's what the media is focusing on, anyway...

What happened to rorty turbo power?"

Bob's take on the general subject and perennial debate over cupholders in cars:

So what's wrong with providing both what people *want* to lay out their hard earned grickels for, AND the verities that make Saab unique?

**Discourses cont. to next page**



Starting around '86 or '87 I started hearing about cupholders in vehicles and started bugging the design department at Trollhättan to get to work.

They pointed at the small indentations on the inside of the glove box lid of the 900, as though that answered my request. I replied, of course, that a) those small indentations fitted European metric cans, but didn't work so hot with U. S. sizes; and b) they were totally useless to a driver while the car was in motion.

"In motion? You mean ... while driving?" This was a totally new concept, and more or less unacceptable.

I kept flogging away, and soon was carrying U. S. size juice and soda cans with me on every trip, each heavily marked with a thick black brush pen: "United States Size." When the "new 900" was in the clay mockup stage, they were fooling around with making the door pockets accept U. S. size cans. This didn't make the cut.

Now, with the 9-5 maybe Saab has the world's best, most innovative cupholder. It only took a little over a decade, but By God, They Did It!

# ROBERTI MOTOR CARS

## Specializing in Previously Owned SAABs

**HOME OF THE 100% WARRANTY**

**Largest Volume Used Saab Dealer in U.S.**

**40 to 60 Pre-Owned SAABs in Stock At All Times**

**Prices Range from \$3,000 to \$20,000**

**SAAB PARTS (New & Used)**

**385 Foxhall Ave.  
Kingston, NY 12401**

**914-339-SAAB**

Visit us on the web at [www.roberti.com](http://www.roberti.com)

## MSS Exhaust Systems for V4, 99 and 900 (thru '93)

Quality exhaust components to improve performance. Systems are designed and fabricated in our shop from mufflers and exhaust tubing aluminized inside and outside for long lasting performance.

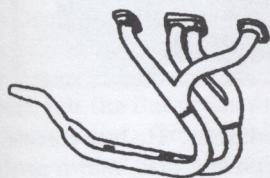

**Header for 99 2.0**  
w/o catalytic converter  
or Lambda

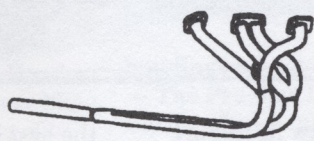

**Header for 900**  
w/o catalytic converter.  
Includes fitting for Lambda sensor



**Header for 900 8-valve**  
with catalytic converter.  
Includes fitting for Lambda sensor

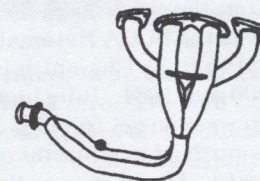

**Header for 900 16-valve**

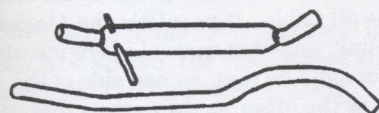

**Muffler & tailpipe for 99/900**  
8V and 16V Turbo models

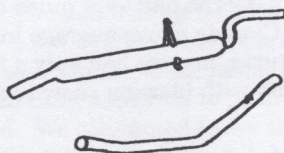

**Muffler & tailpipe for 99/900**  
non-turbo 8V and 16V.

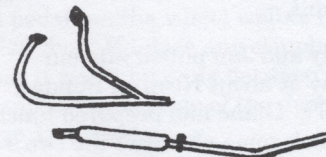

**Header/muffler/tailpipe for Sonett V4/III.**  
Similar system to fit 95/96 V4  
available with new quieter muffler.

[Sorry, no exhaust for 9000 or 900 94-on]

**In Stock Now - Boge hydraulic  
rear shocks for Sonett and 96.**

### Motor Sport Service

1400 E. Second St.  
Phone: 716-665-4200

Jamestown, NY 14701  
Fax: 716-665-4202



by *time winker*

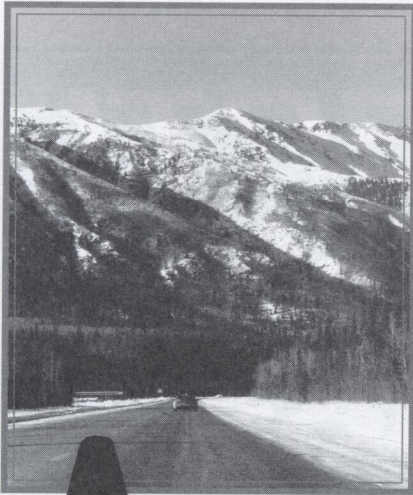

# When It's Springtime in Alaska

**A**s part of the introduction of the new Saab 9-3, you may read about a promotional trip in which a pair of 9-3s were driven from Prudhoe Bay, Alaska, to Key West, Florida, in just over 96 hours. That adventure has already been written up in several magazines and newspapers.

But before this event could take place, the cars had to get to Alaska. That's where I come in.

The "1998 Saab Alaska to Florida Challenge" was organized by Billy Edwards, former PR director for Hemelgarn Racing and a past winner of One Lap of America. Assisting Billy with planning the route was Jon Davis, who puts together the course for One Lap, and was the SCCA National Production Class Pro Rally Champion in a Saab 99 in 1980 and 1981. Billy had planned to take a week to get from his home in Ohio to the farthest north point one can drive in Alaska. My job was as the relief driver to take over when fatigue struck either of the others on the journey to the start point.

Billy and Jon pulled into our driveway at about Noon on Sunday, March 8<sup>th</sup>. Diane had prepared lunch for us, we took some photos of the two 9-3s next to my '79 99 parked by the barn, then we hit U.S. 2 West. We made it about halfway across North Dakota that night, encountering some of the worst weather of the entire trip in western Minnesota - blowing snow and icy roads.

Monday was a very long day, covering the distance to Calgary, Alberta - about 1,000 miles and 16 hours in the

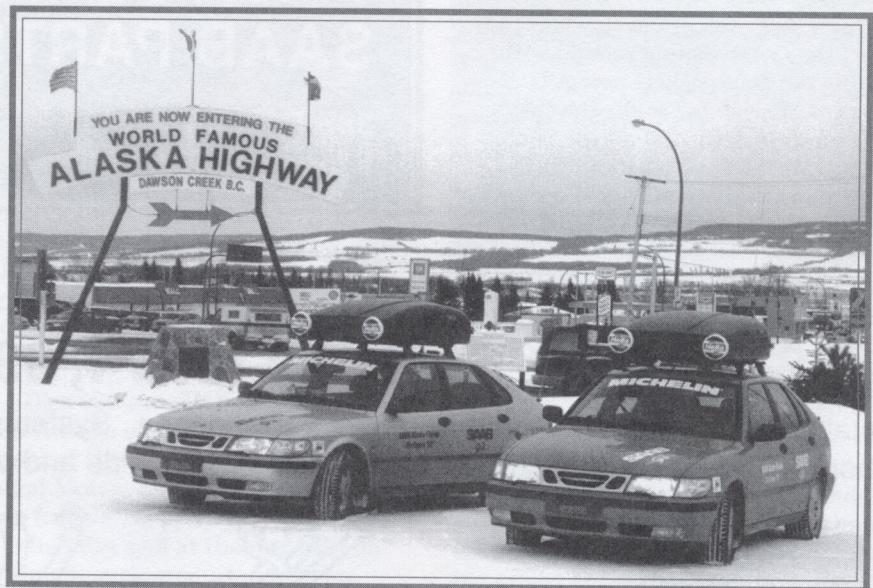

seat. Tuesday evening saw us in Fort Nelson, B.C. after another very long day. We made our next overnight in Whitehorse, Yukon, then Fairbanks, Alaska on Thursday. El Nino enhanced weather patterns had kept much of Western Canada above average in temperatures, and we had only a few more bouts with blowing snow to slow our pace.

the best of conditions. He was correct. The Dalton Highway, also known as the Haul Road, is the antithesis of a vacationers paradise. It is mostly unpaved, and the road is primarily for the use of large trucks that haul goods to the North Slope oil fields. It parallels the Alaska Pipeline, and that marvel of engineering can usually be seen on one side of the road or the other as they criss-cross over

## "1998 Saab Alaska to Florida Challenge"

Billy had allowed two days for the assault on the James Dalton Highway, the final 500 miles between Fairbanks and Prudhoe Bay, figuring we would be able to average only about 45 MPH in

the distance. Though it is a fairly wide road, there are plenty of risks to the traveler: icy roads, frost heaves, herds of caribou. It was almost a certainty that some glass - windshields, headlights, fog



lights - would fall prey to rocks tossed into the air by the deep treaded tires on the trucks that make up the bulk of the traffic on the Dalton.

There is only one gas station on the Dalton Highway, at Coldfoot. The owners also call it a "resort", as sleeping rooms are available at the Arctic Acres Inn, but the accommodations are pretty minimal, especially in March. A large sign in the compound at Coldfoot indicates the coldest recorded temperature in North America occurred there on January 26<sup>th</sup>, 1989, when it reached -82 F. It was balmy by comparison when we arrived... +26 F. The restaurant manages to keep a good stock of fresh food thanks to the daily visits by large trucks from the south.

The extra overnight stop in Coldfoot turned out to be helpful as we did make a few protective additions to the cars. Both had windshield dings and a broken fog light apiece, and one had a chipped headlight. In addition, rocks had peppered the chrome grilles so that they looked nearly sandblasted, and a few of those quartz missiles had passed through the openings to put dents in the radiators. Rather than risk further damage, the headlights and grilles were treated to the protection of cardboard, duct tape and heavy-duty clear tape.

For my final day on the Haul Road, about an hour north of Coldfoot, we passed the "Farthest North Spruce Tree" and headed up through the Atigun Pass. The temperature on the Saab Information Display dropped to -17 F. From there the scenery was quite stark. There were the mountains of the Brooks Range, but the flat areas were more like a rolling desert. Occasional herds of caribou cluster near the pipeline, and there are settlements around the pipeline pumping stations, but very few who choose to live this far from civilization.

While the name "Prudhoe Bay" is pretty well known, the town where the oil company workers stay is called "Deadhorse." The Arctic Ocean and Prudhoe Bay itself are accessible only on guided tours as the oil companies own the rights to the shoreline. Since the primary purpose of the town is removing oil from the earth, entertainment is minimal, limited mostly to video rentals or books. There are no movie theaters, no bars, and the only restaurant is part of the motel. There are two motel

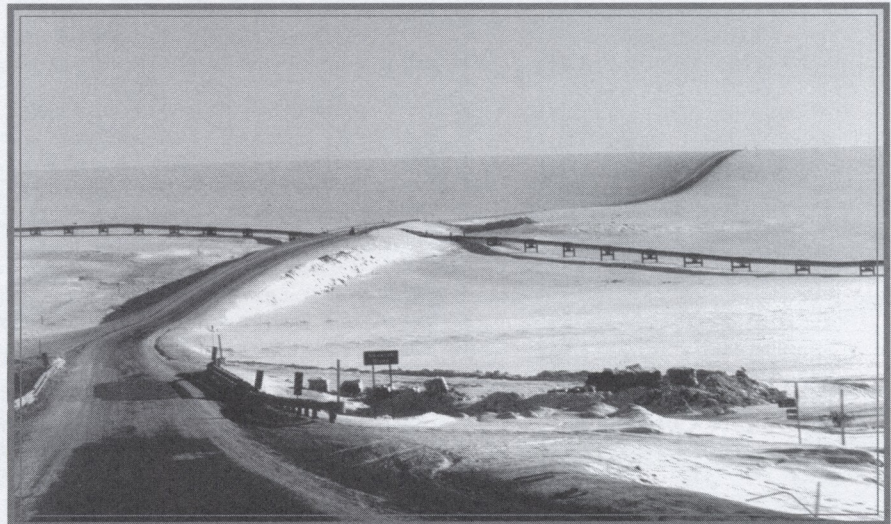

buildings operated by the same company — The Prudhoe Bay Hotel and the Arctic Caribou Inn — and like the facility at Coldfoot, both are pre-fabricated, mobile-home type structures strung together.

Deadhorse was also in the midst of a warm spell... it was only -9 F when we arrived. The sun was up for 12 hours, but only a few degrees above the southern horizon. On the other hand, Polaris, the North Star, appeared to be directly overhead. We attempted to see the Aurora Borealis, but an ice fog shrouded our view of the skies much of the evening.

Despite the long hours in the seat, the comfort of the Saab seats left us all *without* the extra pains usually associated with long distance travel. The heated seats were also a blessing first

thing each morning, as temperatures were usually below zero. The well documented frost heaves on the Alaska Highway and the Dalton were calmly absorbed by the re-designed suspension of the 9-3. Another addition to the 9-3 that comes in handy on long trips is the "dead pedal" on the wheel well to rest your left foot. If I dare any complaint, it's that it was a bit snug between the floor and the underside of the dash for my size 12 Reeboks.

Over the long miles we also made use of the Saab Information Display (SID), keeping an eye on temperature changes, and calculating distance to each fill of the fuel tank and the estimated time of arrival at waypoints based on our average speed.

Springtime *to next page*



# FOREIGN AUTO PARTS

## SAAB SPECIALISTS

KYB Gas Shocks - **\$29.87**

99/900 Mufflers,  
Bosal brand - **\$57.78**

Catalytic Converters  
from **\$148.97**

MANN Oil Filters - **2 for \$10**

Air Filters,  
99/900 Non-turbo - **\$9.48**

Ball Joints - **\$24.79**

REPCO Metal Master Brake  
Pads - From **\$22.20**

Rebuilt Brake Master  
Cylinder - from **\$88.92**

BOSCH One-wire  
O2 Sensor - **\$39.39**

900 Heater Valve - **\$79.00**

REBUILT STARTERS,  
ALTERNATORS, CALIPERS,  
BOSCH IGN. & F.I. PARTS  
AND LOTS MORE!!!!  
**AT DISCOUNT PRICES**

M/C AND VISA WELCOME  
WE SHIP ANYWHERE

BRATTLEBORO, VT 05301  
**U.S. TOLL-FREE**

**800-544-4600**

**802/254-8729**

## Springtime (cont.)



Michelin had provided a new snow tire called the Arctic Alpin for the journey, but saw only minimal use in its expected ice and snow environment. On the rare occasions when we did see adverse weather, the Michelins performed exceptionally well. Look for these new Michelins on the market next Autumn.

We picked up Rik Paul, reporter and photographer for *Motor Trend* magazine, who would be using the red 9-3 for

## Saab News cont. from page 25

### Historic Saab Returns to Sweden

Another historic Saab will soon make its appearance at the Saab Car Museum in Trollhattan. The museum has agreed to purchase a Saab 99 EMS Rally Car from John Buffum of Burlington, Vermont. This particular car was part of an effort by Saab's U.S. distributor to get involved in the sport of PRO Rally in this country and in Canada. The story of that effort was told by Saab's former public relations man, Len Lonnegren, in NINES #230.

The 1976 99 EMS 2-door sedan, converted for rallying by the Saab Competitions Department, was driven in several European events, then sold to Saab in the U.S. Equipped with a special 16-valve head designed and built by Saab's competition department, the Rally EMS won its first North American event, the 1977 Rally Pierce Neige in Canada, driven by Jean-Paul Perusse of Montreal. The original chassis was badly damaged from a season of rallying, and the competition pieces were transferred to a 1977 99 body shell by Buffum's rally shop, Libra Racing. Later that year, at the hands of ace Saab rally driver Stig Blomqvist with Buffum as his co-driver, this Saab was victorious at the La Jornada Trabajosa PRO Rally in California.

The car remains as it was last raced, with the rare 220 hp, 16-valve powerplant and close-ratio, non-synchro gearbox with limited-slip differential still intact. While the engine was homologated for European Group II, more liberal rules in the SCCA PRO Rally series allowed the used of panels made of other than stock material, so the hood and trunk were replaced with lighter weight fiberglass pieces. In addition, the 99 now has an American-style fuel cell made by ATL.

magazine photos. After thousands of miles on unpaved roads, the 9-3s were both covered with a patina of dirt. Billy arranged for a local shop to wash both cars, but the rate would be \$80 an hour. By the time they were finished, the bill came to \$440!!!

On Sunday afternoon the other members of the Challenge arrived via Alaska Airlines and began their final preparations for the trip to Key West. I, however, was leaving Deadhorse on the same plane so only had the chance to wish them well. Their stories will be found in The New York Times syndicate, european car, Saab Soundings, Motor Trend, NWA World Traveler, Robb Report. You'll also find stories on the Internet at The Saab Club site <[www.saabclub.com/articles](http://www.saabclub.com/articles)>; The Car Connection <[www.thecarconnection.com/cc\\_saga1.htm](http://www.thecarconnection.com/cc_saga1.htm)> and Saab Cars USA <[www.saabusa.com/community/events/2challenge.html](http://www.saabusa.com/community/events/2challenge.html)>.

Buffum kept the car, knowing it needed some restoration work and fully intending to finish it someday. Reality and other interesting cars intervened, however, and Buffum decided to sell the 99 a couple of years ago. He advertised it in NINES and found some interest, but no buyers.

While talking with the NINES editor at the Saab 50<sup>th</sup> Jubilee celebration at Waterville Valley last year, Peter Backstrom, curator of the Saab Car Museum, was reminded that this 99 was for sale and nearby. He made the trip to Libra Racing in Burlington, Vermont, had a chance to drive the car, and began to work toward purchasing it for the Saab Car Museum.

According to Backstrom, "This rally car represents a vital part of our collection that has been missing." The 99 rally cars in the Saab Competition Department were rebuilt each year, upgrading to the latest technology and rules. Immediately following the era of the 16-valve engine came the 99 Turbos, and all of the factory-backed Saabs were rallied in that configuration until the Competition Department closed in 1980.

"This car needs only minor work to restore it to original rally configuration," said Backstrom. "It has the rollcage and seats that were used at that time, and the hood and trunk can easily be replaced with steel parts as were required by Group II rules."

"We intend to keep this rally car running with the 16-valve engine. Despite the rarity, we have some spare parts for the engine and the transmission. It will be used for exhibitions and media tours, much like many other rare Saabs we have in the museum."



800-428-8211

FAX (in WA) 206-784-5696

OR FAX 800-447-6740



SAAB Find your own road.

The most knowledgeable staff in the business.

## FACTORY PARTS

## OVERNIGHT SHIPPING

# 20% OFF ALL THULE ACCESSORIES

### REFERENCE MANUALS

900 16V REPAIR MANUAL..... (includes turbo).....	39.95
900 8V REPAIR MANUAL.....	39.95
95, 96, 99, 900, 9000 ALL IN ONE QUICK REFERENCE PARTS CATALOG.....	5.00

### A/C CONVERSIONS R12 to R134

900.....	90.00
9000.....	140.00

### ACCESSORIES ASK FOR A CATALOG...THEY'RE FREE

CELL PHONE SIGNAL AMPLIFIER PATCH.....	21.95
TWO TONE POLY/COTTON SAAB HAT.....	14.50
SAAB MOUSE PAD.....	7.50
CARGO STABILIZER.....	9.95
WATCHES, SHIRTS, PENS, COATS & LOTS MORE !!!	

### GENE'S V-4 CORNER

FRONT BRAKE PADS.....	29.95
REAR BRAKE SHOES.....	49.95
V4 WATER PUMPS.....	60.00

### SPRING FORWARD WITH A TUNE UP

16V 900 POWER STEERING BELT.....	13.50
16V 900 A/C BELT.....	16.00
84-93 900 ALTERNATOR BELT SET.....	12.00
81-93 900 WATER PUMPS.....	65.50
2.0LTR 16V TURBO 900 AIR FILTER.....	12.80

### MANAGER'S SPECIAL

**CONTINENTAL TIRES FOR JUST \$55.00**  
SIZE...195X65X15

900 CLUTCH PEDAL & BUSHINGS.....	32.00
BOSCH FOG LIGHT LENSES.....	13.00



HOURS 8-5 PST  
MONDAY - FRIDAY

see our web page at [www.cartervwsaab.com](http://www.cartervwsaab.com)

CALL NOW TO ORDER 800-428-8211



# A Hardheaded Review of the Saab 9-5

~ By Joel M. Kauffman ~

## A. Introduction

As we now own our 6th, 7th and 8th SAABs, we were among the strongest boosters of this former maker of innovative, mechanic friendly and owner-friendly models. After reading at least 10 extremely favorable reviews of the replacement for the 9000 as well as reading Anders Tunberg's book<sup>1</sup> my expectations were very high; this may have been part of the problem. The next 3 sections are supposed to be factual.<sup>2</sup> My personal reaction to the 9-5 will then follow. The vehicle tested was a '99 9-5 2.3 L ipt with 4-speed auto. trans.<sup>3</sup> The outside temperature was 50° F so neither heater nor air-conditioner were evaluated, and roads were dry. There was no sun-roof, or traction control, or fans in the front seats. Systems performing similarly to ones in the 9000 are not mentioned in Sections C and D below. For example, the engine performed a little better, while being quieter. The transmission was operated in Sport mode only, and did well, with an occasional rough upshift.

## B. Promises Broken<sup>4</sup>

The 9-5 was to have had a double-wishbone front suspension; instead it retains the trouble-prone McPherson struts which are so expensive to replace compared with the plain shock absorbers of the old 900. The 9-5 was to have a longer wheelbase; in fact it measures 2703 mm vs. 2672 in the 9000, hardly

significant. A 5-speed automatic transmission did not appear.<sup>5</sup>

## C. Improvements in the 9-5 vs. the 9000

1. Collision protection: Pretty hard to evaluate without destroying the car. Tunberg<sup>1</sup> writes of many structural improvements. The active front head restraints<sup>6</sup> and side airbags must be a plus, but see D.1. below. Folding rear head restraints are neat for driver vision and easy rear seat folding. Impact absorbing cells minimize damage up to 15 kph

2. Noise: Wind noise is extremely low and mechanical noise is lower, but see D.3. below.

3. Ride: Less jarring over middle-frequency bumps and no swaying at all.<sup>7</sup>

4. Interior: Double sun visors are very nice.<sup>8</sup> Front center arm-rest has neat fore-and-aft motion that allows for driver size and permits both hands on steering wheel with both elbows supported. The particle filter for cabin air has been augmented by an optional fume filter based on activated carbon. Front dual-temperature controls. Remote trans. range indicator is much improved, but should be twice as large. The key is ideally located on the center console, but see D.5. below. There are six (SIX) windshield squirt nozzles! Air-conditioning, seat-heating and dual cup-holders plus recessed "table" in the folding arm-rest for the back seat are nice; however,

the lid for the "table" will not stay up at all.

5. Trunk: Huge lid opening, plenty of tie-down loops, nice set of distress triangles, knee pad over spare tire.

6. Engine Area: Nearly all relays are the same size and small<sup>9</sup> so only 1 or 2 low-cost spares need be carried, or substitution can be done easily in case of a problem; but see D.8. below.

## D. What We Have Lost<sup>10</sup>

1. Collision Protection: The front belts have no adjustable upper mount. The automatic adjustment may be OK for mass-market cars, but not for the supposedly highly intelligent buyers of SAABs, because the range of movement is not sufficient, and the belt rides on the neck<sup>11</sup> of my wife who is not abnormally short at 5' 2" (157 cm). The driver's belt would not retract fully when released. The bumpers are supposed to be self-repairing in up to 8 km/hr collisions as in the 9000, but the fill material is no longer urethane foam, but a bouncy conglomerate of elastic pellets that may not store energy, but will release it at once.<sup>12</sup> This material has very little tear strength compared with the polyurethane in the 9000 since I could remove a piece with bare fingers.

2. Brakes: The ABS<sup>13</sup> did not click to indicate its operation. Attempts to use it gave longer stopping distances with tire screech and rubber streaks up to 10

1. Anders Tunberg, SAAB 9-5, A Personal Story, Norden Publishing House Ltd., St. Gallen, Switzerland, 1997

2. I apologize in advance for any errors of fact, and will welcome publication of correction(s) in NINES.

3. VIN YS3ED48E9X3000761 with 900 miles on the odometer on 14 Apr 98, to be precise.

4. Georg Kacher, Automobile, 9/95, p16.

5. This is not a pipe-dream, some Lexus models have it.

6. Invented by GM Research, Tunberg, p78.

7. Of course, when the ride of a new 9-5 is compared to that of an old 9000 with hardened front struts, the 9-5 seems far better. The improvement is modest over a 9000 with Koni struts and shocks.

8. First seen on the '91 Taurus.

9. Just like the older 99s.

10. From Ken ("Purple Prose") Purdy's book "Kings of the Road" with Chap. 1 of this title, ~1948.

11. Just where it could cut the jugular vein or carotid artery.

12. At least it is better than styrofoam in recovery if not in energy absorption.

13. Anti-lock Brake System.



meters long from speeds of only 60 kph.<sup>14</sup> There was also some minor slewing not present in the 9000.

3. Noise: Some booming from the body was noted. Tire roar from concrete or other rough road surfaces was even worse than than in the 9000.<sup>15</sup>

4. Handling: Rapid lane changes reveal tail-wag (oversteer).<sup>16</sup> While its steady-state cornering is fine, a benign response to swerves resulting from surprises on the road is more important than absolute cornering power in real-world driving.<sup>17</sup> Both steering feel and chassis feel have deteriorated to average from the stellar standard of the 9000.<sup>18</sup>

5. Interior: The front seats provoke a feeling of "Aaahhh!" on initial sit-down, but the support under the butt is inadequate, and effects resembling those of a toilet seat soon are felt. The seats are several cm lower than in any other SAAB model, and thus are down at the undesirable industry average. The seat backs now have a convex curve; my

back does not have a concave curve to match. If all earlier SAAB seats were orthopedically correct, as I believed, then those in the 9-5 are not. The 9-5 is the first SAAB model ever to earn this opprobrium for seating.

The brake pedal, which is now too high above the gas pedal, has its support located up and to the right of the pedal. The support arm gets stepped on during hard acceleration.

The center console is too wide and rubs on the driver's right leg.<sup>19</sup> The auto. trans. lever is ergonomically inferior and generic. "Black Panel" is a wash. For me it is too close to "idiot lights" in function. The clock and the odometers<sup>20</sup> can no longer be read with the ignition off — a real annoyance, however mainstream this cheap system is. The information center is much more confusing with far too much stuff in the active window. The smaller (10 pt?) print and pointers are very hard to read with bifocals in daylight to find which

function the large displayed number represents.<sup>21</sup> The loss of a voltmeter and a starting voltage indicator is appalling.<sup>22</sup>

The single front cup holder is cute and in a good location, but having just one of them is idiotic compared with the pair in the 9000 and almost any other car. If used, the cup holder in the center bin makes the small bin useless for any other purpose including arm-resting, and is in an extremely awkward position. There is not even a flat spot on the front doors big enough for me to mount a boat-type cup holder. Lack of other storage bins is a travesty compared with the 9000. There are no cubby holes in the instrument panel at all. The front map pockets are so small that typical folded road maps will not fit un-deformed. The glove box cannot be reached from the driver's seat, and is too shallow for much more than the owner's manuals, so having it refrigerated is of little value. The radio is no longer removable in an

14. There is no valid excuse for such poor ABS, which I now realize will become the industry standard. Rest assured that the short stopping distances given in car magazines are a result of the driver modulating the brakes as though there were no ABS. (The Sales Manager at my dealership admitted to doing just this to get good stops.) A system that yields longer stops from a harder push on the pedal is totally irrational, as shown by this chart.

If the operator must modulate to get the best stopping, there is no advantage to ABS. The lack of loud clicks obscures vital information that the ABS is operating, and that the surface is more slippery than supposed. Finding out about the surface traction by the sound of screeching rubber or crashing into something is where we were 15 years ago. Felix Bosshard, Charles River Saab, testing a different 9-5, verified the absence of clicks, but insisted that the ABS is perfect otherwise.

15. As in the 9000, this is caused by lack of compliance in the shock absorbers at normal ride height. It is much less pronounced when Koni shocks and struts are used, as they should have been in both the 9000 and the 9-5.
16. The problem was mentioned by Tunberg, p92; but not really solved as he indicated.
17. Other fwd models with independent rear suspension such as Lexus ES 300 and Honda CRX have excellent behavior in rapid lane changes.
18. It is hard to improve on the perfection of the rear suspension of the 9000. Despite the move to 6.5" wheels (from 6" in the 9000) and to 55-series tires (from 60-series) the cornering force of the 9-5 has deteriorated to 0.77g (Road & Track Guide to the SAAB 9-5, 1998, p15) from that of the 9000 (0.77g in Car & Driver, 9/95, p145; 0.79g in Car & Driver, 9000CS Turbo test reprint, 1993).
19. James R. Healey, USA Today, 18 Feb 98, p38, noted this also.
20. I have been told that a button push will make the odometer(s) readable with the ignition off.
21. The older system where one thing at a time was displayed was far better.
22. Knowing whether the entire charging system is functioning properly, or whether a drive belt is broken, or how the battery is doing was very valuable. The remote battery check is not an adequate substitute.

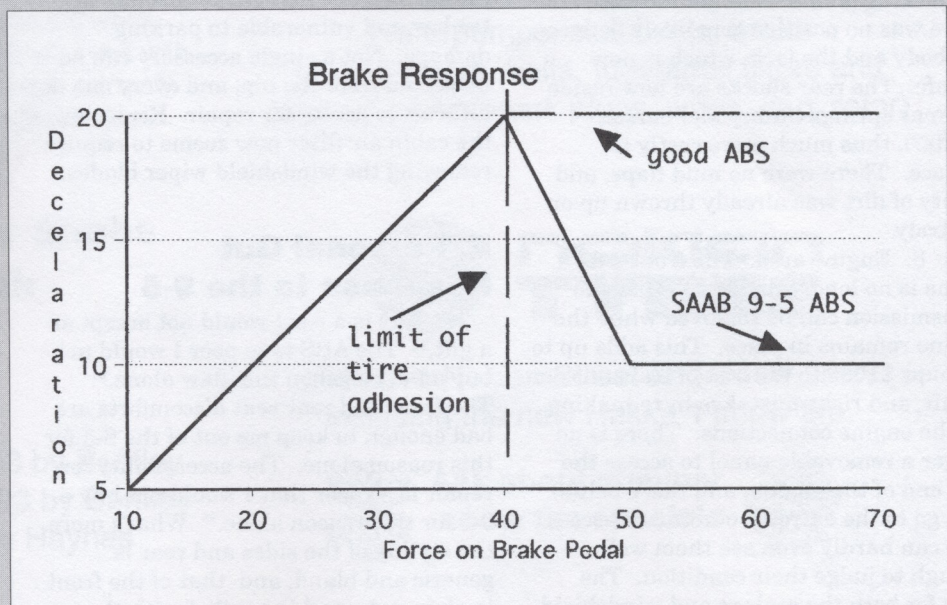



instant for storage, repair or replacement by a standard-sized non-SAAB brand.

The middle of the rear seat is a rock, and there is no foot room in the middle, oddly making this large car a 4-seater rather than a 5-seater. Foot room in the rear is pitiful, with little under the front seats, exacerbated by a center tunnel big enough for a rear-drive truck. Rear door pockets have vanished, and the itty bitty net bags are a joke. No more rear heater ducts for the feet. Folding rear seats no longer produce a flat floor.

6. Lighting: White entry lights are now teeny and in a very awkward position for bulb replacement. Red warning lights on all four doors: Gone! Only a pathetic red reflector remains. Rear focused reading lights both sides: Gone! Underhood light: Gone!

7. Trunk area: Tool kit: Gone, except for multi-blade screwdriver. Flex wrench for moving power seats: Gone! The jack securing strap was so hard to secure that the dealer rep. could not do it. The jack itself no longer fits into easy-to-find channel sockets on the body, and the jacking points were not obvious, and there was no positive grip likely between the body and the jack, which is now unsafe. The rear shocks are now inside the rear springs (funny McPherson struts?), thus much more costly to replace. There were no mud flaps, and plenty of dirt was already thrown up on the body.

8. Engine area: The front sub-frame is no longer divided so that the transmission can be removed while the engine remains in place. This adds up to perhaps \$1000 to the cost of transmission repair, and risks mistakes in re-making all the engine connections. There is no longer a removable panel to access the belt end of the engine, and the V-belt(s) now go to the extreme of difficult access. One can hardly even see them well enough to judge their condition. The caps for both the coolant and windshield



cleaner fluids are on the same side of the engine, the same color, size and shape. The black cover on the header tank makes the coolant level hard to see. The battery is neither a maintenance-free type, nor does it have finger-only caps for easy fluid checking. Its black cover will not help to keep it cool, and discourages fluid checks. The power steering dipstick is not labeled. The transmission dipstick is not labeled and the faint print "Dexron III" will be unreadable when some dirt arrives. The brake fluid reservoir is down to f 50-100 mL from the f 500 mL in the 9000 and even the old 900, a substantial volume that would compensate for some leaks. The modern fad of covering things adds useless weight and cost, and makes all access more difficult, as well as preventing easy discovery of loose contacts or leaks. The air-stop pad near the left foglight was falling off. The foglight connectors are too low and vulnerable to parking damage. Not a single accessory can be inspected from the top, and every one is difficult to access for repair. Replacing the cabin air filter now seems to require removing the windshield wiper blades.

## E. Personal Gut Response to the 9-5

This is a car I would not accept as a gift.<sup>23</sup> The ABS is so poor I would not buy a 9-5 based on this flaw alone.<sup>24</sup> The front and rear seat discomforts are bad enough to keep me out of the 9-5 for this reason alone. The accessibility for repair is so poor that I would not buy a 9-5 for this reason alone.<sup>25</sup> What's more, the styling of the sides and rear is generic and bland, and that of the front is plain ugly, and in conflict with the

rest. For some reason styling now matters more to me than it did for 40 years, maybe because my '93 9000 is the only really good-looking car I have ever owned of 13, including 5 SAABs.<sup>26</sup>

The improvements in ride and wind noise are most obvious, but see D.3. above.

The new gadgets are appreciated, but not a single one is compelling. Perhaps they would be compelling collectively if there were not the ~ 47 losses mentioned above in D. Better collision protection for passengers taller than 5' 6" (168 cm), and more powerful air-conditioning (Tunberg, p63) are the most appealing to me. Yes, the key is better located on the floor.

With the losses in steering feel, chassis feel and handling<sup>27</sup> the classification of the 9-5 changes to a touring sedan or luxury sedan; it is certainly no sports sedan. Now it has to compete with other fwd models that have acquired cabin air filters, front belt height-adjusters and pre-tensioners, folding rear seats, and traction control, as well as costing far less.<sup>28</sup>

My closest friend for 38 years, a mechanical engineer, has told me for years that cars are commodities. I have tried to show him how SAABs, Porsches, and certain awd models are unique. The 9-5 is pretty close to being a commodity that is \$5-10,000 more costly than the competition, albeit with some cute and/or useful new gadgets.

Of course nothing will alter the course of any business decision that results in runaway sales, as has been SAAB's pleasant experience so far with the 9-5.<sup>29</sup> At least SAAB Cars will survive to provide spare parts for the wonderful, expensive-to-produce, technician-friendly, owner-friendly models of the past.<sup>30</sup>

Joel M. Kauffman  
Wayne PA  
e-mail: kauffman@hslc.org

23. Except to re-sell it, of course, should anyone wish to give me one.

24. If there were no ABS I would have rated the brakes excellent.

25. A phrase from Consumer Reports, "thumb-in-the-eye engineering", fits. Once out of warranty, repair costs and challenges become so difficult that the owner trades for a new vehicle. The 9-5 is not the worst I have seen in this respect, merely below average.

26. My wife has owned 3 Saabs.

27. No wonder BMW owners like the 9-5, the Saab that "zigs"!

28. The Toyota Camry V6, Avalon, Lexus ES 300 and Pontiac Bonneville SSEi are some I would now prefer, and each is both faster and cheaper than a 9-5.

29. However, remember that 1,203,517 of the turn-over-prone '60-'63 Corvairs were sold. Car mags were laudatory at first. Now how good do we think early Corvairs were? (This is not to imply that the 9-5 is unsafe beyond its ABS defects.)

30. My participating dealer was very helpful and all of their personnel were extremely positive about the 9-5.



# Garry Small Saab

**Saab exclusive for over 10 years!**

**800-920-7222**

**<http://www.saabstory.com>**

Garry Small Saab has been ranked number one in customer service and sales satisfaction by J.D. Powers and Associates



## **Saab & Clarion Audio Components Repair or Exchange**

We can repair your Clarion audio component and offer a 1 year warranty with a 3 week turn-around or you can exchange your unit with one of our rebuilt units with a 90 day warranty. Rebuilts are sold on an exchange only basis. Call for pricing.

## **Mention you saw us in Nines and get a 15% discount on Genuine Saab parts**

Applies only to the following parts:  
Waterpumps, clutch kits, brake pads & rotors, belts, fuel/air/oil filters and tune-up parts (spark plugs, wires, cap, rotor)

## **Shop Manuals for Saabs \$35.00 each**



Saab 900 8 Valve 1981-88 by Bentley  
Saab 900 16 Valve 1985-93 by Bentley  
Saab 9000 1986-95 by Haynes



We have Nokian Street and Snow tires, including the new Hakka 1 snow tire.



**Ask about summer  
snow tire specials**



Fast, friendly expert service. Non-inflated part or freight prices.  
Extensive Saab inventory. Late shipping by a variety of carriers.

**800-920-SAAB**

**Business hours: 8:00 AM to 5:30 PM PST  
All major credit cards accepted**

Advertised prices are good for 90 days after the published date for this issue of Nines.  
This advertisement MUST be mentioned at the time of sale to receive discounts.



# Lot of Cones

## How You Can Race too!

### The His-tory

For most of my life I have been a motorsports fan and an automobile enthusiast. My enthusiasm for the speed and glory I saw in motorsports was due in no small part to my adolescent dreams. Those dreams in turn were a product of the environment in which I was brought up, that of a SAAB family. I remember being armed with a wire brush and all my childhood gumption, lifted up, seated upon the rusted floorpan of an upside down Sonett chassis and being instructed to move that brush repeatedly in a reciprocating manner until my arm fell off. Today, 13 years later, I am doing something I have wanted to do ever since I became my father's greasy go-fer. I am racing!

Almost as if there is justice in this crazy world, the car I race is the very Sonett that I helped to restore with the small donation of my right arm. Father has very generously allowed his car-crazy, speed-happy, go-juice-for-blood son to take said father's first restoration project onto the race course. The car is a one of a kind as far as I know, a '68 SAAB Sonett V4 with the roof cut off to make it a roadster. The new body-style is set off by a coat of bright yellow paint and minilite-style wheels from the '80 SAAB 96. Extensive warming of the engine has produced a guestimated 130 hp from the 1500 cc V4. Before my first race, mother thought about all the time, effort, and love that went into building my father's pride and toy and was prompted to ask him the one question I had been too afraid to ask, "What if he wrecks it?" My father replied simply, "If he wrecks it, he'll fix it."

### The Joy

The joy of racing and competition is very difficult to describe. I have raced BMX and mountain bikes with moderate success. I played soccer passionately for most of my childhood. The rush of competition is incredible. I can be completely calm, just sitting down minding my own business and all of a

sudden the idea of competition accosts me! As I write this, there is a tension forming in my neck muscles and my fingers are moving faster and with increased rigidity. I can feel my heartbeat speeding up. I must physically shake it off before I can relax. If I am unlucky enough to think about this much before bedtime, I have trouble getting to sleep! I can relieve the feeling of sitting on the starting line of a mountain bike race with 40 other racers and going over strategy in my head: "OK, it's an uphill start, get off the bike just before they let you go and when they do, RUN! Jump on the bike after the first twenty yards and you'll have a 4 bike length lead on the rest of the field at the first turn!" Reminiscing about my soccer years I think about a missile of black and white stitched leather launched from my left fullback position.

There is a wonderful feeling of counterattack as it flies over the heads of the opposition and lands halfway into enemy territory right in front of the already running forwards.

It is similar the feeling of joyful anticipation as I rev the engine on the starter's "all set" signal at the season's first autocross. VVVVRRZRRZZZOZOOMM!!!! In a rising concert of spinning Yokohama rubber, I'm gone! Heading east, I try to slow the earth's rotation with 1500 cc's of V4 power! The Sonett picks up its nose in eager acceleration! It dives and twists as I left-foot brake into the first turn! The noise is intoxicating inside my helmet! Everything floods into perspective: it's me, the car, the tarmac, the cones, and the timer. Nothing else dares intrude on my senses. Concentration is vital! Concentration is brutal! Flash by the finishing gate and BREATHE! Eyewitnesses report that a serious smile can regularly be seen filling the visor of my helmet as I tool back through the pits. Each run only lasts about 65

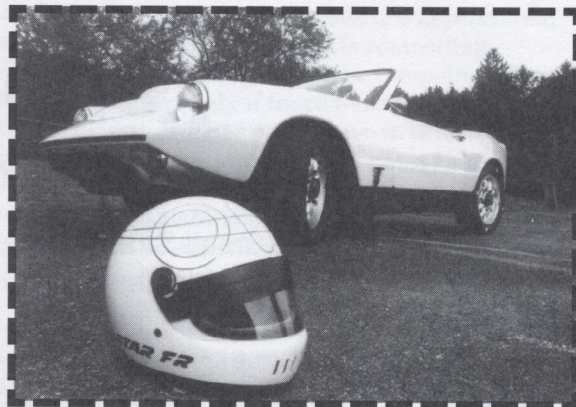

seconds on average. It takes most of the day to manage 4 minutes of track time and I am trying desperately to make my time on the track as short as possible. Why am I so afflicted with perma-grin?

### The Info

Autocross (or Solo 11 in SCCA speak) has an extremely low risk of damage to one's car or person. The initial investment to participate is practically nil, compared to most forms of motorsport. Entry fees range from \$15 to \$25 per event and there ends the major race expense! Apart from a factory seatbelt, a helmet is the only safety item they require and most clubs have loaners available. A tech inspector will go over the car to ensure that nothing will fall off during the race and possibly injure the pavement. You must have a valid driver's license and understand that the right pedal is the "go-pedal." The course will be designated by small traffic cones laid out in "gates" through which you must pass. It would be handy if you could read a course map so that you can navigate your race route through the lot of cones.

Notice I mentioned nothing of a superlicence, sponsorship, roll cage/bar, blueprinted engines, or even race tires! Moreover, some of the closest competition occurs in the stock classes where the cars are what the name implies, dead stock. Essentially the only modifications allowed to a stock class car are safety improvements such as a roll bar or race type seatbelts. You can



throw on autocross special tires but they must be street legal, no slicks (look for the DOT number on the sidewall).

Lowered suspensions and reprogrammed engine management systems are no-no's in the stock classes. You can, however, have the sides of your car plastered with as many go-fast stickers as you like. In fact, some companies, like tire manufacturers, offer incentive programs that reward you with cash and stuff, but you must use their product and run their stickers on your car.

If you get frustrated with the low speed and limited handling of your stock setup and start to make modifications you enter the world of "Street Prepared" competition. I was forced to start my career in Street Prepared because the Sonett already had the modifications to catapult me well out of the boundaries of the Stock class. My class was CSP, where the rules place all sedans over 1.5L and under 3.0L and sports cars under 2.0L unless otherwise classified.

## Speedier Sonett

I would like to explain the two major things that helped me go faster. The first is a better driving technique. Except for the general dynamics of handling, most of what I say will only apply to front wheel drive cars. You may have heard people talk about left-foot braking. If you want to go fast in a SAAB, do it! It takes practice. It feels weird at first but it is the fast way to get around in a front wheel drive car. I first heard of left-foot braking when I read an article reprinted from the 1978 March issue of Car and Driver about Stig Blomqvist. I had heard of him. I knew he was fast ... in a SAAB! In the article, he stated something that I had already found out for myself, "The main problem with front-wheel-drive cars is understeering." No kidding! "Most of the weight and all of the power go through the front tires. If you have understeering and you put the throttle on more, you have more understeering." Understeering is the cars tendency to push, or go straight when the wheels are turned.

One technique used to combat understeering is the "handbrake turn." The idea is to actuate the rear brakes with the handbrake and toss the back of the car around a turn while the front continues to spin freely and grip. Left foot braking produces the same effect only more accurately, and you have both hands on the wheel. To do it you

basically come into the turn and mash both feet to the floor. DOWHAT?! Relax, I'll explain the dynamics of the situation: Tires have less grip when they are sliding and tires slide because they are asked to do more than they are capable of. A balanced car will slide both the front and rear tires at the same time and at the same rate. The balanced car is fictional for all intents and purposes. A car will almost always have a preference for one end to slide first. All Saabs slide the front first. A balanced car with mediocre grip will be faster around a race course than a car with tons of grip at one end and little at the other. Left foot braking allows the driver to control the balance of adhesion between the front and rear tires.

Here's my best shot at explaining this by example: at the last event there was a fairly fast left hander with another tighter left hander immediately following it. This is the dreaded reduced radius turn or "sucker turn." Because of a short straight-away leading in, I was going faster than physics or the gremlins of adhesion would permit me to negotiate the turn so, I let up on the gas and squeezed on the brake with my left foot. Speed having been sufficiently diminished, I re-applied almost full throttle. My left foot was still fairly hard on the brake. This set up the car for the turn by settling the front suspension down and keeping it down. 'Me brakes were acting to the same degree on all four wheels just as they were designed to do except, and here's the trick, I was counter-acting them at the front by giving the throttle "full welly." At that point, the rear wheels were being asked to slow their rotation AND carry the back of the car around the turn. The rears could not handle both tasks and so they slid (as I had intended). Because I was applying (approximately) equal forces of braking and power at the front wheels, their job consisted mainly of steering the car around the turn. They can handle this and if I am doing all this right ... Viola! A SAAB with oversteer! The great part of this song and dance is I can control the balance of the car accurately and quickly. The only thing better than a balanced car is one in which you can control the balance according to your need. As I let up on the brake slightly, the car will begin to return to its normal understeer-

For the Friendly,  
Helpful Service and  
SAAB Club Discount  
you've come to expect,  
call:

**609-924-5101**

or Toll Free

**1-800-705-SAAB**

SAAB *Alfa Romeo* ®

**SPORTS AND SPECIALIST CARS**

1023 STATE ROAD  
PRINCETON, NJ 08540

Authorized **SAAB** Dealer

fax: 609-924-5034

E-Mail: [sns cars@aol.com](mailto:sns cars@aol.com)

ing preference and I can accelerate out of the turn without having to transfer the right foot from the brake pedal. More pressure applied to the brake pedal will turn me more into the turn. If I should happen to overcook the turn, all I need do is let up slightly on the gas and press more on the brake and it will slow me rapidly while retaining steering control.

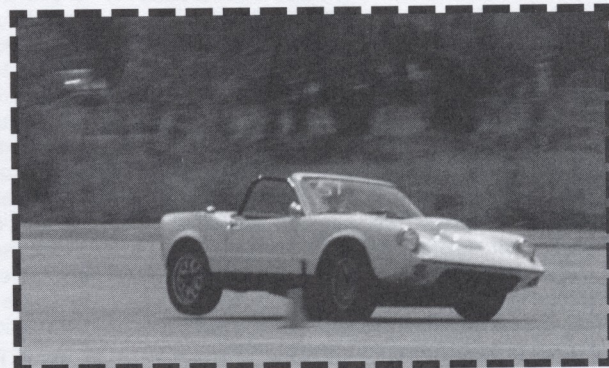

One interesting feature of this technique is that if I do it right, there is very little turning of the steering wheel. I do not need to correct for the slide. In fact, I continue to steer into the turn and control the direction with the throttle and brake pedal. This technique was developed on loose surfaces such as gravel but translates nicely for autocrossing purposes. No single improvement in the car or in my driving

Lot of Cones *cont. to page 75*





**VOLVO, SAAB  
SALES & SERVICE**

Essex & Decatur Streets  
Marietta, PA 17547  
Phone 717-426-2202  
Fax 717-426-2217  
www.swedishmotors.com

*COME VISIT US!*

## SAAB PERFORMANCE PRODUCTS & ACCESSORIES



*\* North American distributors for  
Abbott Racing Motorsports*

**Also Featuring:**

- \* Saber Performance Products
- \* K&N Filters
- \* Brembo Rotors
- \* Jamex Springs
- \* Koni/Bilstein/Tokico Shocks
- \* Aquamist Water Injection
- \* other products

*Accelerated Response Motoring*

5775 Atlantic Drive, Unit 9, Mississauga, Ontario, Canada M3K 1E5

Info: (416) 636-8797, Fax: (416) 630-9066, Orders: 1-888-767-7333

Email: sales@acceleratedresponse.com, Internet: www.acceleratedresponse.com

## Saab take to the Dirt Oval Tracks

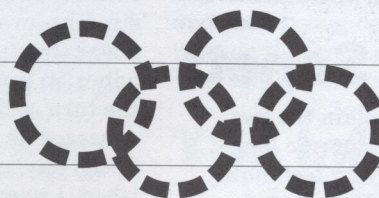

### Pennsylvania

Kevin Booth of Lititz Auto Service has come up with a gimmick that has generated fans for his 900 2-door. The black and white paint scheme resembles a Holstein, and he calls the car Thundercow. Lynn Hyle also races a Saab at Linda's Speedway near Lititz. They have proven that Saabs are quite competitive, each winning several feature races and regularly placing in the top three.

Booth keeps fans abreast of his weekly racing results via the Lititz Auto Service web site <[www.saablitzauto.com/racing.html](http://www.saablitzauto.com/racing.html)>. One of his more exciting adventures was to clip a tire barrier on the last turn of the last lap, barrel-rolling across the finish line in 9<sup>th</sup> place. The Saab ended up on its side, Booth climbed out, stood on the door and bowed to the crowd, just as the car caught fire. Quick work by the safety crews put out the flames. Booth was uninjured in the spectacular crash, and the Thundercow was repaired in time for action the following weekend.

A group of fans now show up each week to cheer for the Thundercow, all sporting bovine hats.

### Texas

Saabs are giving the Pintos and Mustang IIs fits at North Texas Motor Speedway in Roysce City, Texas. Tom McLaughlin, a tech at French's Foreign Car Service in Irving, won the Mini Stock championship last year in his 99, and is tied for first place as of early August. In recent

weeks he has won two features and placed second.

Rules for the Mini Stock class at the 3/8 mile dirt oval require a single-overhead camshaft engine and a Holley 2-barrel carburetor. Tom French has installed a B212 (2.1-liter) Saab engine with an 8-valve "H" head into his '85 900 3-door. He has added a MSS camshaft and valve springs for higher rpms, and modified the stock manifold to carry the required carb.

According to French, "Entry fees are only \$20 a night, and if you finish halfway decent you'll make that back. A top five finish will give you a payback of 60 to 80 dollars."

Another Saab out of French's shop, a 1980 99 that Dave Fremder drove last year, is now driven by Jackie Saunders. Saunders is originally from Connecticut and her father worked for Saab. She has placed in the top ten several times, and has dented the car several times, but she's learning whenever she goes out on the track. Saunders has plans to build herself a new car for next season; another Saab of course.

### New England

*Report by Eric Nelson*

The Western Mass Saab Stock car season is in full swing. We've had a good year running the 1/4 mile high bank oval at Monadnock, NH, and the 3/8 mile Waterford Speedbowl in CT. The last few years we've also run successfully at Riverside Speedway in Agawam, MA.

Some History is appropriate; 4 years ago

there were no Saabs running at these tracks. Then came James Moncrief (of SOB Story) to Riverside where he won 8 out of 11 races his first year! Saabs were on the map.

At NH, which has been a VW track for years, our main competition is from GTI's and CRX's although there are some fast Escort GT's and an RX2. Waterford, until the Saab invasion, had belonged to Rear wheel drive cars, mainly Mustangs, Celica's and Nissan 240 SX's. The Saabs are subjected to untold abuse and are amazingly durable, all the engine lower ends have over 200,000 miles and are original. We run flat out in 2nd gear at 7000 RPM, often with the temperature gauges at +225degrees. The bodies absorb more collisions in one race than most people experience in a life time.

The current team consists of myself as chief mechanic and worst driver, Rich Hammann, a convert from the Ford camp, Rob Pierson a convert from the Toyota camp and Chris Palamar. The cars are: #2 Rob Pierson's extra clean 85 900S 3dr; #28 Rich Hammann's 82 900 3dr (second season); #12 Chris Palamar's 85 900 (ex Rob Pierson), and I'm driving #9 (ex Ron Wilcox) an 82 900S 4dr. on its 3rd full season (an unheard of accomplishment in this racing circle).

For the season at NH: Rich is 1st, Rob is third, Chris is 7th and I'm 12th. Current Standings at NH can be had at [WWW.Monadnockspeedway.com](http://WWW.Monadnockspeedway.com). At Waterford, Saabs won all three races entered; Rob has won twice and Rich once.



# Wigwam Saab

Committed to Quality and Customer Satisfaction

After Market ≠ O.E.M. ≠ Used ≠ Genuine Saab

Do the job once, do it right. Trust only Genuine Saab Parts when making repairs to your Saab.

	<u>Reg.</u>	<u>Sale*</u>
Radiator (Fan contact included) 79 - 93	\$250.00	\$165.00
Radiator Installation Kit (Req. 79 - 85)	9.00	6.50
Clutch Kit 79-83 Turbo, 79-93 N/A (Includes: Press Plate, Disc, T.O. Bearing Slave Cyl., and Pilot Shaft Seal)	200.00	132.00
Brake Caliper 75-87 99 & 900	175.00	115.50
Cabin Fan -93, 94CV 900	135.00	86.90
Cabin Fan 9000 All	195.00	126.50
Water Pump 81-93, 94CV 900	82.00	53.90
Heater Valve 79-93, 94CV 900	105.00	69.30
Heater Core 86-91 9000	250.00	165.00
Outer CV Joint 81-89 900	220.00	103.40
Ball Joint 79-93 900	37.95	27.50

\* Sale ends 12/31/98

Shipping is not included

VISA

MasterCard

American Express

C.O.D.

Please call and place your order today.

Hours: 7:30 - 5pm EST Mon - Fri  
7:30 - Noon EST Saturday

Phone: 401-621-SAAB (7222) R.I.  
888-707-SAAB (7222) Outside R.I.

Fax: 401-723-0340

E-Mail: [parts@wigwamsaab.com](mailto:parts@wigwamsaab.com)

Ask about receiving your **FREE**  
NINES CLUB Discount Card  
CALL TODAY

Wigwam Inc  
915 Charles Street  
North Providence RI 02904



**SAAB**



# Saab Swap

## Sonett For Sale

'74 **Sonett III**, excellent condition, 93k miles, new brakes, clutch, transmission overhaul. Take a Florida vacation and come see. \$3000. Joan Davidson, St. Petersburg, FL. 813-391-4613.

'73 **Sonett III**, 54k mi., mech. very good, solid, new BRG paint, tan int. Driver or local show car. \$4,000 or BRO. H. L. Heminway, P.O. Box 1420, Charlestown, RI 02813. 401-364-6462.

'72 **Sonett** complete project car, rusty pan and rockers, running when parked, lots of good parts, may part out, prefer to sell complete. \$850, offers. Kevin O'Grady, 1631 Maywood Rd., South Euclid, OH 44121. 216-291-0144 evenings.

'71 **Sonett III Vintage Racecar**. SVRA logbook. Originally built by Motor Sports Service. Completely restored and race ready. Package with dual-axle trailer. \$6,500 OBO. Tom Cox, Baltimore, MD. 410-465-6691.

'68 **Sonett V4**. Great body kept original, white, new heads, water pump, new tires, no rust, possible A/C, 90k mi. Tim Stephani, 1800 S. Jefferson, Appleton, WI 54915. 920-735-0133.

## 2-Stroke & V4 Parts For Sale

**Complete parts/project cars** that must go before the crusher gets them. 1973 Sonett, 1972 96 V4, 1966 95 wagon. Many additional parts. Make an offer or request a part. Moyne Metzger, 606-272-7216. Email: mnbm@lex.infi.net.

'67 **MC 850**, extra engine parts, runs. '68 96 V-4 with parts car. V-4 engines, trans., gauges, glass, much more. First \$2800 takes all. Must sell. Bob: W. 920-388-3707; H. 920-487-3162, 5pm - 10pm.

"**Soccerball**" set of alloy wheels for 96/Sonett, incl. tires, lug nuts and center caps, \$150. New old stock 96 rear muffler, \$25. MSS high performance exhaust and pipe for 96, \$75. Steven Rossi, 106 Kent Drive, Cortlandt Manor, NY 10566. 914-736-5354.

'65 **MC 850 wood steering wheel**, cond. "9", \$150 firm +shpg. Dave Yust, 1301 Patton St., Ft. Collins, CO 80524-4231. 970-484-0675.

**Parts for 2-strokers, '65-'68**: Starters, \$20; generators, \$20; triple-carb setups, \$50; more. Tim Winker, 218-729-0826 days.

## 99s For Sale

**Two '78 99 Turbos**. Good shape, 3 door, sunroof, 4 spd & 1 with 5 spd. 1 w/AC, 1 w/o. Runs good 110K mi. Take any reasonable offer. Eddie Mummert, P.O. Box 12, Maugansville Rd., Maugansville, MD 21767. 301-790-0551 leave message.

'73 **99 4 dr.**, 0 mi. on rebuilt. \$1500 for pair (see '80 900T below). Zachary A. Herrick, 1034 Spaight St. #4, Madison, WI 53703. 608-255-8975. Email: Herrick@itis.com.

## 900s For Sale

'91 **Turbo Convertible**. Black exterior, tan leather interior. Low mileage. Automatic. Air conditioning. Stored winters. Excellent condition. \$13,500. Catherine Benincasa, 603-536-9879.

'88 **900 Turbo Conv.** "Springtime in Sweden" edition (SPG trim). Auto trans., low miles (60k), new '93 "Commemorative Edition" wheels w/ new Michelins. One of the nicest examples around, as seen at Waterville Valley. \$10,900. Bill Clark, 1101 Cedar Ave., Bensalem, PA 19020. 215-638-0599.

'88 **900 SPG**, 108k miles, gray/gray leather, recent trans. & clutch, new Michelin Pilots, new headliner, many new OEM parts. Owned & professionally maintained by Saab Master Technician. \$8900. Bill Clark, 1101 Cedar Ave., Bensalem, PA 19020. 215-638-0599.

'80 **900 Turbo**, 3 dr, 5 spd, A/C, stereo/cass, EMS manual steering, Inca alloys & extra set steel wheels, runs/looks great. Everything works, \$1000 to a good home. Eric Barr, 463 Lowell Pl., Fremont, CA 94536. 510-797-6760. Email: EGBarr@Juno.com.

'80 **900T**, 3 dr., 12k on 5 spd, new exh. \$1500 for pair (see '73 99 above). Bad motor. Zachary A. Herrick, 1034 Spaight St. #4, Madison, WI 53703. 608-255-8975. Email: Herrick@itis.com.

## 99, 900 & 9000 Parts & Accessories

**Used GROUP 6 chip set** for 9000 Turbo \$225 obo. (954) 295-8071.

**Sport Exhaust** for 1994 and newer Saab Turbo. Original Saab part (1100251306). Only on car for 250 miles. Asking \$250. Chris Allen, P.O. Box 7337, Santa Monica, CA 90406. 310-394-7069.

**Parting out '89 900S** black w/ tan interior. What do you need? John Bottger, P.O. Box 25133, Richmond, VA 23260. 804-288-7697.

**Saab 16V go fast parts**: pink K&N filter, Andrews tweaked APC box, Andrews variable rate fuel pressure reg, PIAA rally lights, ALFA rally computer, rear bumper cover new. We'll hash out a bargain price. David, 313-881-2977.

**9000 parts**: Seats front and rear, alloy wheels, power steering unit, rotors, calipers, radiator, gauge cluster, brain, misc. elec. switches, 5 speed tranny. Paul Tacy, 11547 Bladensburg, Ottumwa, IA 52501. 515-684-0349.

**900 parts**: Signals \$20 to \$40, '88 SPG wheel \$100, AT 70k \$500, '88 turbos \$150, window motor \$35, dashes, wheels, much more. Henry Castellon, 7 Oak Gate Drive, Branford, CT 06405. 203-488-5611.

**Accessories for pre-'87 900**: European H4 headlights \$150; 4 silver Shelby (Mini-Lites) wheels with Hakka tires \$450; 4 steel wheels with Nokia tires \$100; 4 Inca hub caps (new in box) \$60; Front nose mask/bra (never used) \$50; Shadow aluminum rear window louver (O.E. Saab) \$125; Hella Rally 2000 lights with bracket \$150. The Mrs. wanted a "family" car! Marc Rosenkilde, 99-31 64th Ave. #C9, Forest Hills, NY 11374. 718-459-2454.

'80 **900T** motor, lots of spare parts. Zachary A. Herrick, 1034 Spaight St. #4, Madison, WI 53703. 608-255-8975. Email: Herrick@itis.com.

**99 Turbo air conditioning** package, compressor, condenser, etc., new! \$100. Steven Rossi, 106 Kent Drive, Cortlandt Manor, NY 10566. 914-736-5354.

'78 **99T parts car**. Very solid body complete except for Inca wheels. Will part out or sell whole car for \$200. Moyne Metzger, 606-272-7216. Email: mnbm@lex.infi.net.

**Turbo "B" engine**, 10k miles on total rebuild, special crank & rods, new head pistons & turbo. Spare turbo

cartridge (never used) with 99/900 early housings. Complete 99T exhaust without converter. Engine on 4-speed with 20k on rebuild. Whole package for \$2000 OBO plus shipping. Dennis at 715-453-9525 or 715-848-0588.

**900 & 9000 Parts**, turbo & non-turbo, all years, all models. Engines, transmissions, doors, interior, electrical, suspension, lights, bumpers, wheels, accessories & much more. Dave at European Car Parts & Restoration, 57 N. Plains Industrial Rd., Wallingford, CT 06549. 203-949-4881.

**99, 900 headliner kit**, comes w/glue, 3-1/2 yards & complete instructions, \$87.50. Other parts available. Trollhattan Motors Inc., 410-682-4688 or 1-800-32-TROLL.

## Wanted - All Models

**1991 Monte Carlo yellow 900C**. \$100 for leads resulting in purchase. Wife & gearhead seeking newer stand out Saab! Ken - 978-768-7624; Esxsol@AOL.com.

**1985 900 Saab dashboard**. Mine has cracks in it & I would like to replace it. Phyllis Dunn-Lusita, 35 Hayes Lane, Ridgefield, CT 06877. 203-431-9836.

**Fuel level sending unit** (in the gas tank) for a 1980 99 or 1980 900. 1980 Saabs used a plastic gas tank that requires a special sending unit that is unique to that year. E-mail or write me if you have one. Will pay \$50 for good used example. Gregg Cronn, 2322 H St., Bellingham, WA 98225. 360-671-7196. Email: gcronn@SHS.bham.wednet.edu.

'72 **96 V4 headlight assembly**, shift link assembly, horn mechanism for wooden steering wheel, side reflector lens (red), fog lamps for 1968 Monte Carlo, black vinyl & nylon seat covers (no rips or holes), electrical mesh for heated seat, rheostat for light panel, voltage regulator, ball joint w/ nipple, oil pump & pickup w/s rubber for rear of hood, tie rod end, brake adj. tool, horn & bracket, 160 degree thermostat. Bill South, 200 Idlewyde Dr., Louisville, KY 40206. 502-899-9434.

## Miscellaneous

**SAAB ORIGINAL sales brochures** showing all Saab models, interiors/features. Great for Restorations or Gifts! 1956-59, \$20 each year; 1960-69, \$15 each year; 1970-79, \$12 each year; 1980-present, \$10 each year. Add \$3.50 shpg. VISA/MC. Specify year, model. Have literature all cars/trucks/motorcycles, worldwide. Walter Miller, 6710 Brooklawn, Syracuse, NY 13211. 315-432-8282. Fax: 315-432-8256. Web: www.autolit.com.

**Vintage Tools** from former Saab Dealer for sale. 93, 96 & early 99, Complete Dealer Sets. Brand new hood for 93, 2 used V4 left hand doors. J. G. Service, 346 Electric Ave., Lunenburg, MA 01462. 978-342-6860.

**Saab factory banner**, 2 1/2' x 10', blue vinyl with white logotype, great for your garage! \$25. Steven Rossi, 106 Kent Drive, Cortlandt Manor, NY 10566. 914-736-5354.

**Saab Rallye poster** signed by Erik Carlsson, 28" w. x 39" h. \$150 firm +shpg. Dave Yust, 1301 Patton St., Ft. Collins, CO 80524-4231. 970-484-0675.

**Independent used Saab sales & service dealership for sale**. Excellent location in busy resort area in the middle of Saab country, in beautiful Vermont. Established customer base and steady walk-in traffic. Long term lease available. Asking \$75,000. Serious inquiries only. John, P.O. Box 11, Topsham, VT 05076. 802-439-5414.



# Fall Specials

We have recently expanded our facility and now offer a nationwide mail order service.

Our other services include:

- Overnight Shipping
- A Full Line of New & Used Parts
- In-House SAAB Transmission Repair

## Fall Specials

**From  
Seattle's  
Foremost  
Independent  
Saab  
Repair  
Shop**

Sport and Rally Headlights, '87 & newer	220.00 ea.
900 Clutch Master Cylinder	70.00
9000 Clutch Master Cylinder, up to '89	110.00
9000 Clutch Master Cylinder, '90 & newer	100.00
Bougicord Wire Sets, All Models	40.00
900 Front Wheel Bearings	35.00
9000 Front Wheel Bearings, up to '90	120.00
9000 Front Wheel Bearings, '91 & newer	130.00
ATE Power Disc, 900 '88 & newer	55.00 ea.
ATE Power Disc, 9000 '88 & newer	55.00 ea.
CV Joint Kits, 900, '81 & newer w/ boot and grease	100.00
AC Idler Bearing w / Pulley, All	20.00 ea.
900 Power Steering Racks <i>Lifetime Warranty</i>	145.00
9000 Power Steering Racks <i>Lifetime Warranty</i>	150.00
Soft Headlight Protectors	29.95
Antenna Masts, '85 on	18.00
Gold Headlight Bulbs	13.00

All parts carry a 12 month / 12,000 mile warranty  
If you don't see what you are looking for, give us a call. We stock a full selection of new and used parts for old and new SAABs. If we don't have it, we can probably tell you who does.



## Scandia Autosport

9520 Greenwood Ave. N.  
Seattle, WA 98103

1-888-90-TURBO or (206) 789-2819 in Seattle Fax (206) 781-5281

<http://www.scandiaauto.com>





# Back Issues of NINES

At right is a listing of back issues of NINES that are still available. The price is \$6.00 per issue ppd to U.S. addresses. Any 10 available issues for \$50.00 ppd. [Non-member prices: \$8.00 ea, \$65.00 for 10 issues.]

The supply of those marked with an asterisk (\*) is very limited. Those with a line through them are no longer available, though copies can be made for \$10.00 per issue.

Collection of all remaining issues, total value over \$150.00.

## \$90.00

[Non-members, \$120.00]

Includes U.S. postage.

Postage to Canada: add \$3.00 US  
Overseas (Surface mail): add \$6.00 US

# Nines

**Saab Club License plate frames, Black plastic, fit all Saabs.**

#301 ..... \$3.00 each  
#302 ..... \$5.00 / pair

**Saab Club decals, blue, yellow & black; printed on vinyl, safe for use on glass, metal or painted surfaces.**

#901 ..... \$1.50 each ppd  
#902, ..... 4 for \$5.00 ppd

**Saab Club Golf Shirts**

100% cotton, white, new logo on left breast.

#261, L or XL (specify) ..... \$19.00  
#262, XXL (only 2 left) ..... \$24.00

Add \$4.50 per order for shipping plus \$1.00 for each additional item (Shipping included on decals and back issues)

Shipping to U.S. addresses only  
Allow 4 to 6 weeks for delivery  
Sorry, no phone orders or C.O.D.s

Send check or money order to:

**Saab Club Extras**  
7675 Bear Trap Jct.  
Saginaw, MN 55779-9672

#193 (6/90)  
#195 (9/90)  
#197 (11/90)  
#198 (12/90)  
#199 (1/91) - Index 1990

#200/201 (2-3/91) - 200th Issue - 20th Anniversary; Traction Control System; Tow bar mount for Sonetts; Restoring Sonett chassis; Turbocharger care; History: Erik Carlsson - Saab's Rally Ace; LACAR, a very modified 900.

#202 (4/91) - Correcting water leaks in 900s; History: 3-cylinder, 2-stroke; Lonnegren remembers; Shipping crates for V4 & 2-stroke engines; MSS Header & exhaust; 96 upkeep

#203 (5/91) - 9000 A/T fixes; Neutering the V4 freewheel; Care of the V4 Gearbox; Magazine Road Test summary

#204 (6/91) - 900 Fuel pre-pump; Lubrication analysis; The 99/900 Transmission; Thermo Accumulator

#205 (7-8/91) - Winter Beater Mk. II: '85 900T; Curing delaminating doors on Sonetts; Water cooled Turbo kit; Review: The Machine That Changed the World.

#206 (9/91) - '91 Nat'l Convention: Crystal Mtn, WA; Extending the 96 front bumper; Zymol car cleaning system, a review; The Barber Saab Pro Series.

#207 (10/91) - Test drives: Special Edition Convertible & 9000 2.3 Turbo; '92 New Models; Weber 34 ICH for V4s; Adding gauges in a 900; Cleaning 2-stroke exhaust; Audio replacements; Replacing 900 CV boots.

#208 (11/91) - '91 Alcan 5000 Rally; Changing V4 valve seals; Fix for 16V cold running problems; Stroker Saabs find new homes.

#209 (12/91) - Improving taillight ground circuit on 900 sedans; Boosting turbo performance; Test drive: 9000T w/TCS; Race & rally results

#210 (1/92) - Index: 1991 (#199-#209); Saab Friction Tester; 95/96/97 Shipping crate; Gearbox protection; Auto shows display.

#211/212 (2-3/92) - New CV boot clamps; Ashcraft's Fast Freddy Sonett V4; Larger tires for 9000; Jon Davis - Saab's US Rally Champion.

#213 (4/92) - FWD Car Museum; Saab Soundings Vol. 1, No. 1; Group 6 APC box; Fast Freddy Sonett V4 update.

#214 (6/92) - Saab Mechanics List; Saab at the Baja 1000; Brakes; Electric sunroof fix; Skip Barber Racing School.

#215 (8/92) - '93 New Model intro; '92 Nat'l Convention: Columbus, OH; 900 Turbo tips; Possible horn malfunction: 99/900; Shocks: KYB vs. Bilstein; Several V4 tips.

#216 (10/92) - Today's Saab Aircraft; '92 Int'l Meet: Austria; Spark Plug recommendations (all models); 99/900 Caliper "clunk"; 99/900 CV boot replacement; V4 tips; Satch Carlson: Stuck in Dawson Creek.

#217 (12/92) - Saab Miniatures: Catalog of model Saabs; US Gov't vs. Old Cars; Recycling antifreeze; Factory Service Manual listing; Modernizing old Saabs; Erratic fuel gauge readings due to Gasohol.

#218 (4/93) - Index: #210-217; Secrets of APC; Buying Time: Flat rate vs. Straight time; Cracked A-arms on 900s; Saved by the belt; James Bond's 900 Turbo; 236-mile 96 V4; 325,000 mile 95 V4; Stuck parking brake: 99/900.

#219 (7/93) - Power steering flush; 900 oil drain plug; 9000 clutch M/C; History: The beginnings of Saab in the U.S.; 95/96 rear brakes; Audio upgrade in a 900; Racing a 99; R&T reprint of '63 Monte Carlo Rallye.

#220 (10/93) - Introducing the New 900; '93 Nat'l Convention: Kenosha, WI; A/C for the '90s; New clutch slave for 99 & 900; 95/96/97 CV boot replacement; Resurrecting a 900; Owning a 9000 in Canada.

#221 (1/94) - Your Sexy Sonett; Features & Reviews of New 900; Binding ignition switch contacts: 99/900; Broken 900 crank pulley; Proper care of V4 transmission; History: '65 Pan American Endurance Race.

#222 (5/94) - Quantum/Saab Formula "S" Register & details; 9000 Radiator fans malfunctions; 9000s as Colorado Police Cars; Resurrecting a 99EMS; Tires: Pirelli P700; Vacuum leaks in a V4; 9000 Aero vs. Turbo; Rude Awakenings: Reviving a 99 5-dr.

#223 (7/94) - Overheating 9000 A/T backup light switch; History: 1980 24 Hours of Nelson Ledges & Baja 500 in a 99; Fitting aftermarket wheels; DIY Tools: Brake caliper tool & Pressure plate press; More power: Transmission ratios & Turbo intercooler; Suspension rebuild on 99/900.

#224 (10/94) - Curing cold driveability in early 16V engines; Brake fluid recycling; '95 New Models; Interview w/ James Crumlish; Meets: Int'l, Vintage & Nat'l; Adding a Clarion CD changer; Replacing seat support; 900 alternator removal & repair.

#225 (1/95) - Index: #217-#224; Fog lights explained; Examination of PRO Rally Champion 99; 900 water pumps: OE vs. Aftermarket; Driving the 9000 Aero; Intermittent DL. \*

#226 (4/95) - "Flawed Report" on 9000 fires; 16V transplant into 99T; Change 16V timing chain in the vehicle; Repair cracks in 9000 rear wheel housings; High mileage Saabs

#227 (8/95) - Electric 96; Windshield leakage and corrosion; Leasing a Saab; Turbo tune-up; Help revive Satch's Hawg of Steel; Adventures with Bill the Goose.

#228 (12/95) - '95 Nat'l Convention: Atlanta, GA; V4 Brake M/C; Tires: Pirelli P6000; Shocks: Koni; One Saab- Four different events; Saabs & Sci-Fi; Driving the Sensonic Clutch; Rally tales: GRRR & Lake Superior PRO Rally; Future engine technology.

#229 (3/96) - Headliner replacement; 16V Retrofit to earlier 900; Tires; 900s: Classic vs. New; Diagnosing CIS problems; 2-stroke & V4 tips; Sonett floor repair.

#230 (6/96) - Saab Returns to Rallying; History: 77 99 EMS 16V; Report from The Lost Patrol; Timing chain guide wear; Sudden engine stalling; Adapting door mirrors for tall drivers; 2-stroke fanshaft bearings; V4 Tips; Index #225-#230.

#231 (8/96) - Sonett body removal; Out at the Lake Vintage Meet: Lake Placid NY; Installing TCS On/Off switch; Replacing V6 camshaft belt; Insure Wisely.

#232 (11/96) - 900 Talladega Challenge; '96 Nat'l Convention: Kirkwood CA; 1960 RAC winning 96; Sonett glass replacement

#233 (2/97) - Foggy Gauge Repair; Rebuilding a 16V engine; Review of Dex-Cool; Fair value when your car is wrecked; 2-stroke tips - Keep It Simple; Bob Sinclair takes a 93B on the California Mille.

#234 (4/97) - Saab at Bonneville; Sonett floor pan refinishing; Anti-lock brakes; Electrical Faults; Pedal raising kit; Photos of the new 9-5; Special edition models; Facett/Sonett Super Sport Found; Teaching Teens to Drive; 95 rear suspension.

#235 (7/97) - Photographing your Saab; 900 8V Timing chain replacement; Sonett Restoration: Detailing engine compartment; Chrysler's Neon 2-stroke; Radio interference on AM; Satch Carlson on the Thunderbird Rally.

#236 (12/97) - Saab 50th Jubilee Celebrations in Trollhattan, Sweden, and Waterville Valley, New Hampshire; Northern Lights Challenge (Vintage Saab Tour); R12 to R134a A/C conversion; Sonett Interior Restoration; 1998 Saabs.

#237 (4/98) - 9-5 and 9-3 debut; Oil filter dissection; Convertible Etiology by Bob Sinclair; DI cassette failures; Cracked A-arms - 900; Sonett Front End Rebuilding; New Oil for Manual Gearboxes, 2-stroke brakes.

Send check or money order (payable on a U.S. bank) to:

The Saab Club - Back Issues  
7675 Bear Trap Junction  
Saginaw, Minnesota 55779



separate electronic systems: a radio-frequency for doors and infrared for the ignition. It looks like an excellent anti-theft device as there are no mechanical keys that could be easily reproduced.

Dislikes: The seats are not heated and there was no steering adjustment, items I would have expected in a European sedan within this price range. I'm sure they are available as options, but that raises the price again. Also, a clip holding the inner plastic fender in place popped out and the lightweight fender liner began to rub against the tire at speeds above 70 mph. It became a bit of an annoyance, and certainly out of character with the Mercedes reputation for fine engineering.

Mercedes has a new electronic 5-speed automatic transmission that theoretically should allow for quicker get up and go, and apparently it does so compared to the earlier C280. Unfortunately, it was not as smooth as the 4-speed Aisan-Warner automatic in the 9-5. When trying to kick down for passing or quick acceleration, the M-B tranny would pause for a second or two before reacting. As a result, I found it preferable to shift manually when negotiating the switchbacks of the Rocky Mountain foothills. The shifter for the automatic transmission is gated, not the squeeze-button style used by Saab. I found I had to look at the gate to figure out which gear I wanted to go into instead of just squeezing the button and moving the shift lever. While I probably could have gotten used to the Mercedes shifter, I don't think I would ever enjoy it.

Overall the C280 is a terrific machine, but dollar for dollar I would choose the 9-5 as the far better value. More standard equipment, more power, more fun-to-drive.

One more piece of the expanding puzzle that is NINES reveals itself with this issue. Natasha Medwedeff, a Saab Club member from the Boston area, is now doing the layouts.

Natasha started her business, Time Ink, in 1991. She specializes in computer and print design services.

When she's not behind her monitor (a major Mac enthusiast) she *loves* being outdoors - driving a 1987 Saab Convertible, spending time with family and friends. .. biking, boating and enjoying life.

## Books for the Saab Enthusiast

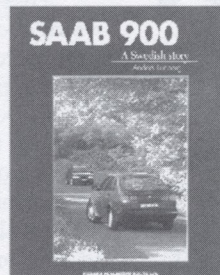

#126 - **The Spirit of Saab** (1992) by Rolf Bleeker. The people who made Saabs a unique form of transportation were themselves unique characters. Bleeker interviewed many of them for a different historical perspective.

Was \$22.95, now ..... \$16.95

#128 - **Saab 900: A Swedish Story** (1993) by Anders Tunberg. An in depth look at how Saab developed the second generation 900.

Was \$19.95, now ..... \$14.95

#129 - **The Saab-Scania Story** (1987). A history of Saab aircraft and cars, Scania trucks and other industries under the Saab-Scania AB banner. .... \$14.95

*Save even more!* All three books for \$39.95 (+\$6.00 shpg)

Add \$4.50 per order for shipping plus \$1.00 for each additional item  
Shipping to U.S. addresses only  
Allow 4 to 6 weeks for delivery  
Sorry, no phone orders or C.O.D.s

Send check or money order to:  
**Saab Club Extras**  
7675 Bear Trap Jct.  
Saginaw, MN 55779-9672

### Lot of Cones *cont from page 39*

has taken more time off my runs than left foot braking! The key is practice. Eventually your left foot will get used to moderating a pedal instead of just throwing in the clutch.

All that being said, when you go to your first autocross, do what is comfortable for you. If you are uncomfortable with left foot braking, you will be faster without it. It's slightly controversial and it is hard on the brakes.

Now that you have the information to become a front wheel drive master, you will want to know what to do to your car to make it a more suitable mount. Get new sneakers! Not for you, silly, for the car! It has been suggested that a good set of autocross tires will take two seconds off any time you can manage on street tires! I use Yokohama 008 RSH'S. They sell for about \$130 a piece. The most effective change I made to the car was the tire setup. The problem was getting enough grip at the front of the car so that I could apply more power through the turns. I currently run 225/50x15's on the front and 205/50x15's on the rear. Notice that the front tires are significantly wider than the rears. This alone helps to balance the car. Second, notice that the

tires are 50 series tires. That is the only way they will fit on the car. They fit very nicely on the rear and do not rub at all. In fact, the 195/60's that were on the car previously did rub, where these do not. The front tires JUST fit. They have plenty of room at the fenders and don't rub when the steering is turned to full lock, unless the tire is unweighted. In that situation I get just a slight rubbing of the inside sidewall on the coil spring. The situation is under review and I plan to have a remedy for next season. I refuse to go to a smaller set of tires! I just bought new fronts and I love the grip! Besides, it would ruin my balance!

## Cool Down

Finally, have a great time! It is my enjoyment of the competition and the people that prompt me to write this stuff. I'd like to share the fun so come out and join us! I'd relish the opportunity to compete against another CSP Sonett!!

*Stefan Vapaa*  
Wilmington, DE  
Stefanv@aol.com



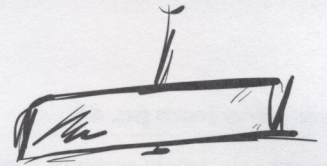

## A Black SPG arrives, a Black EMS must go

A recent addition to the Saab stable is a Black 900 SPG, a model that I have lusted after since it first appeared in late 1984. Appropriately enough, it is an early 1985 model built in October, 1984. The chassis has 142K, but minimal rust. It replaces the "Bronze Metallic" 900 known as Winter Beater Mk.II, which donated its drivetrain, as the engine on the SPG had melted due to abuse by the previous owner. The folks at Andrews acquired the car after the P.O. decided not to have it repaired. As part of the deal, the body-work and paint were touched up, and a Burgundy Velour interior replaced the badly worn leather.

While the barns at Saab Club HQ are not full of Saabs (not yet), it has also become time to do some re-evaluation of the projects that are there. Since more interesting project cars have arrived, others must go. In addition, there are three 1978 99 Turbos that need to be stripped and sent to the scrapyards, plus the above mentioned WB Mk.II; due to rust, none are worth saving.

The culled project was a black 1976 99 EMS. It has found a new owner in Minneapolis. This particular EMS is not perfect, but is in darn good shape for a 22-year-old 99 that was finished at the Belgian factory. The odometer reads only 68K miles, and that is probably accurate. I bought it knowing that most of the pieces to restore it are readily available. My intention was to run it in Vintage Rallies, as the rules allow for cars 20 years and older. Unfortunately, with more interesting projects arriving since then, its priority has dropped to the bottom, meaning it would be years before I can get to it. Besides, I have a couple of other 99s that are now 20 years old.

Most of the EMS models were built in Mechelen, Belgium, while that factory was utilized from 1973 into 1978. Due to poor body prep at the Belgian facility, paint was known to flake off the EMS bodies in a matter of only a few years. Consequently most of those cars have long ago gone to Valhalla. Very few original EMS 99s still exist, though their parts, especially the alloy wheels, tachs and steering wheels, have found their way onto other 99s.

There was something very cosmoicly weird about the recent announcement that Mercedes-Benz and Chrysler were going to merge. The news broke while I was in Denver, accompanying Diane on a business trip. What was odd was that I had borrowed a C280 from the Mercedes press pool in an effort to get a feel for some of the competition for the Saab 9-5. In addition, I had arranged a meeting with Frank Barrett, the editor of the Mercedes Benz Club of America's magazine, *The Star*.

In the grand scheme of things, I don't pay a lot of attention to Mercedes. More so than most of the domestics, but low on the list of European imports. There were, however, several revelations that came about as the result of this encounter.

It seems that many Mercedes buyers often choose that marque less for the engineering than for the nameplate. Mercedes-Benz is a well recognized brand name, and there are people who desire the prestige of showing off the brand. This happens also with BMW and Porsche. I find all of these cars to be wonderfully engineered and fun to drive, but do not wish to own any due to the owner stereotypes that have built up around the brands.

Saab, and maybe to a lesser degree Audi, in addition to being well engineered, seem to attract the anti-Mercedes, anti-BMW driver. Volvo has its own stereotypical owner, one who is bent on owning the safest car available. While many owners may fit the stereotypes, the cars don't necessarily.

Based on real world statistics, Saab, Mercedes and Volvo, in no particular order, are best at protecting the occupants in an accident. BMW, the "Ultimate Driving Machine", has the reputation of being fun to drive, yet they, too, are generally safer in an accident than most makes. It seems as though the Europeans care more about safety for safety's sake, rather than as one more marketing tool, as it has been used by the Japanese and American manufacturers in recent years.

For anyone who has studied marketing in the last couple of decades, there is less emphasis on the product and more on the image. Pay attention to advertising and you'll see very little product, and more focus on how the product makes you feel. It's gotten to the point where market-

ing costs nearly equal production costs in the final price of a vehicle. Remember the ad for Chevy's Camaro a few years back that proudly stated "A cup holder large enough for a Big Gulp." Somebody must have thought that was important, but I certainly don't.

Saab's marketing department seems to realize that their product appeals to the anti-prestige - or possibly alternative prestige - crowd. Pokes at BMW and Mercedes get the attention of these potential Saab buyers, so it may well be that we'll actually see ads like the proposed "Last one to Aspen is a BMW."

Back to the C280 that I was driving. The C-class is the "entry level" luxury sedan from M-B. The C220 is the four-cylinder version, the C280 has a 2.8 liter V6. The C280's new-for-1998 V6 replaces an in-line 6 of the same displacement and horsepower. There has also been much written in the car magazines lately about a C43, a beefed up C-class with a V8. Price on the C230 starts at \$30,450 while the C280 begins at \$35,400, comparable to the top-of-the-line Saab 9-5 SE with the V6. The particular car I drove had the Sport package, an \$890 option that includes 16-inch alloy wheels, performance tires, leather upholstery, firmer suspension and special interior trim.

Likes: As expected in a Benz, the C280 is quiet, so quiet that I had to check the tachometer to make sure it was running at idle. That quiet extends to on the road, which makes the next part more enjoyable - the sound system. The factory installed stereo (Bose?) is exceptional.

The windshield wiper was also impressive; yes, wiper... singular. It is on an articulated arm that is able to clear much of the flat windshield glass with each sweep. The intermittent wipe position on the switch operates based on the amount of friction on the glass. If less rain, the blade sweeps less often; if more, more often. It is one of those cool features first found on the Citroen SM that didn't catch on back in the 1970s.

One oddity is the new electronic key system called SmartKey. It is a bit heftier than current keys, plugging into the door locks or ignition and operating them with



# MEMBERSHIP/SUBSCRIPTION

(Use also for Change of Address)

Address change only - old zip code \_\_\_\_\_

NAME \_\_\_\_\_

ADDRESS \_\_\_\_\_

CITY/STATE/ZIP \_\_\_\_\_

HOME PHONE \_\_\_\_\_ WORK PHONE \_\_\_\_\_

E-mail address \_\_\_\_\_ Fax # \_\_\_\_\_

SAABS CURRENTLY OWNED:

Example: Year 1995 Model & trim 900 SE Body style 5 door  
 Engine 2.5 liter V6 Transmission 4-spd auto VIN# Y53DF58UXS2000000

#1: Year \_\_\_\_\_ Model & trim \_\_\_\_\_ Body style \_\_\_\_\_

Engine \_\_\_\_\_ Transmission \_\_\_\_\_ VIN# \_\_\_\_\_

#2: Year \_\_\_\_\_ Model & trim \_\_\_\_\_ Body \_\_\_\_\_

Engine \_\_\_\_\_ Transmission \_\_\_\_\_ VIN# \_\_\_\_\_

Please include additional cars on a separate sheet of paper. Color, mileage and add-ons welcome as well. VIN especially wanted on older cars (10+ years).

Membership fees for the SAAB Club of North America/NINES are as follows:

New membership \$34.00  
 Renewal \$30.00

Canadian add \$4.00US  
 International add \$8.00US

**Please check appropriate box(es)**

(Canadian and International - Money order or check payable on a U.S. bank only. Cash OK.)

New members receive the most recent back issue of NINES and two SAAB Club stickers.

**MAKE CHECKS PAYABLE TO  
 "THE SAAB CLUB"**

Mail to: Membership  
 The Saab Club of North America  
 7675 Bear Trap Junction  
 Saginaw, Minnesota 55779-9672

## SAAB OWNERS BEWARE

Traffic police assume Saab owners have above-average incomes, which is why they target you for traffic tickets. They think you're more likely to pay up than to contest their revenue-generating practices in the courtroom. However, they overlook the fact that Saab owners are more educated and more motivated to stand up for their rights.

**Let us help you fight that ticket!**  
 call the

**NATIONAL MOTORISTS ASSOCIATION**

**for Membership Information Now!**  
**1-800 SPEED TRAP**

or visit our Web Site at [www.motorists.com](http://www.motorists.com)



**National Motorists Association**

402 West 2nd Street, Waunakee, WI 53597  
 Phone: 1-608-849-6000, Fax: 1-608-849-8697  
 E-mail: [nma@motorists.com](mailto:nma@motorists.com)



We're the organization responsible for the repeal of the 55 mph National Maximum Speed Limit. We could do much more with your support. Consider joining the one motorists' rights organization that truly represents your interests in issues such as emissions inspections, auto insurance, photo RADAR, red light cameras and speed traps. Most importantly, members have access to ticket-fighting assistance, attorney referrals and more information on fighting tickets than is available anywhere.





BULK RATE  
U.S. POSTAGE  
**PAID**  
RED WING, MN  
PERMIT NO. 282

7675 BEAR TRAP JCT.  
SAGINAW MINNESOTA 55779

Address Service Requested

## #238



FITZGERALD'S  
EUROPEAN AUTOMOTIVE



Jon Fitzgerald  
1921 Dallas Drive  
Baton Rouge, LA 70806

504-929-9008  
Fax 504-929-8982  
Appointments Preferred

**TROLLHATTAN**  
**AUTO PARTS INC.**

**SPECIALIZING IN PARTS FOR SAAB & VOLVO**  
OEM, OE & AFTERMARKET PARTS AVAILABLE  
PARTS DISCOUNTS UP TO 50% OFF LIST PRICE  
**CALL FOR MONTHLY SPECIALS**

**SAAB** 1800-32TROLL **VOLVO**  
<http://www.cybertroll.com> 410-682-2827

MOST ORDERS SHIPPED WITHIN 24 HOURS / VISA, MASTERCARD & AMERICAN EXPRESS ACCEPTED

**800-270-SAAB, Parts**  
**412-238-0099, Fax**

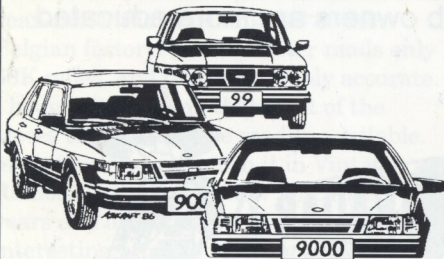

**DENNIS SWEENEY**  
ROAD TESTED SAAB PARTS  
334 Wilpen Road  
Ligonier, PA 15658

Late model Road Tested  
900s and 9000s for sale.

**Rebuilt transmissions, 900 and  
9000, manual and automatic**

Used mechanical and electrical parts,  
interiors, accessories, sheet metal, rebuilt  
steering racks, wheels, heads.

Same day shipping on most items.

**BE HAPPY  
ON THE  
WEB**

**SAAB**

**LITITZ  
AUTO SERVICE**

VISIT OUR WEB SITE  
<http://www.saablitzauto.com>

