

NINES

THE SAAB CLUB NEWSLETTER

\$2.95
April
1991
no. 202



'70 95 at Portland Harbor. Photo by Rob Perry.

Safest Sedan - Saab 900

page 4

Life with Lonnegren

page 10

Shipping and storage of engines

pages 12 & 14

A rear drive Saab roadster

page 22

'91 National Convention Latest

pages 2 & 17



Rallying an Entry Level 9000
page 8

Regional Club News

Appalachian SAAB Club

April 27 - Picnic meeting, Hill climb, Chimney Rock, NC

May 18 - Meeting/Show, TRA Imports, Knoxville, TN

June 8 - Roan Road Run/Rallye

Ken Edwards
296 Brethren Church Road
Jonesborough, TN 37659
615/753-3153

New England Sonett Club

May 11 - Picnic, Parapsco Valley State Park. All Saab owners welcome!

Tom Cox
3609 Hernwood Road
Woodstock, MD 21163
301/465-6691

Saab Club National Capitol Area

June 15 - Troubleshooting Tech Session by Don Danneman, Laurel, MD

Contact: Toby Turpin, 301/384-6732

Mid-Ohio Sports Car Course

June 22 - Summer Meet for all vintage cars. Over 300 competitors. For further information call 1-800-MID-OHIO or 614/876-3203

Ohio SAAB Club

June 30 - Annual Summer Family Picnic, 1:00pm. Please RSVP before 6/23. Pete Rechnitzer, 216/243-1488.

Dallas/Fort Worth area

May 4 - Car Car Clinic, V4s thru 9000s, begins at 9am. French's Foreign Car Service, 925 Luke St, Irving TX 75061. 214/399-1222.

Carlisle Import Auto Festival

May 17-19 - Flea Market and Car Corral, Carlisle, Penna. Clubs welcome. 717/243-7855.

Correction

The phone number for the Crystal Mountain Resort given in earlier issues was incorrect. The correct number is: 206/663-2558.

'91 Convention Update

The site chosen for the 1991 Saab Owner's Convention is the Crystal Mountain Resort, located in Western Washington, east of Mt. Rainier National Park. It is situated deep in the Cascade Mountain Range fourteen miles northeast of the summit to Mt. Rainier. You can locate the resort on any up to date Washington State road map. First locate Seattle. Follow a straight line to Mt. Rainier National Park, eighty miles to the Southeast. Find highway 410 which leads North out of the park on its Eastern border. At the junction of the Northeastern corner of the park and highway 410, is the road leading to Crystal Mountain Resort. The resort complex lies at the end of a "delicious" six mile "SAAB" road. Nestled at the end of a glacial valley is your destination. Many of the buildings are of Alpine architecture.

Plenty of recreational opportunities exist at the resort. Tennis, horse back riding, hot tubbing, swimming, hiking, mountain biking and scenic chair lift rides will keep you busy. You can even take rented mountain bikes up the chair lifts with you and ride back down the hiking trails! The wide range of accommodations should please everyone.

Even though Western Washington is well known for its rainfall, you probably will not see any. High temperatures at the resort normally range from 50 to 75 degrees in August. But depending on weather, temperatures could stretch from 40 to 90 degrees! Daylight will last until 9:30 P.M.

A full line-up of convention events are scheduled. Seminars, an informational concourse, and a driving tour to Mt. Rainier's "sunrise" lookout is planned. And absolutely do not forget your camera!

You will see glaciers, high Alpine meadows, deep forested valleys and wildlife. There's even an outside chance to see the Northwest's most elusive creature - the Sasquatch!

Last fall, a "Bigfoot" was sighted less than 20 miles from the resort. There's a rumor that a local club member, (the same person who owns the rare 4-door 96) will lead a mid-night Sasquatch hunt. So bring your night-view thermal scopes and cameras - but no guns or dogs, (sorry Vigen)!

There is a well stocked sport and gift shop for anything from hiking gear to souvenirs. A small convenience store is also located at the resort.

SAAB Club of North America
2416 London Road, Unit 900
Duluth, MN 55812-2221

218/ 724-1336, 9am - 6pm Mon - Sat
Fax number: 218/ 728-6307

NINES Editor & Publisher:
Tim Winker

Editorial Ass't / Membership
Joan Oswald

NINES is published eleven times a year (monthly except August) as a service of the SAAB Club of North America. The SAAB Club is not affiliated with Saab Cars USA, Inc. or Saab Automobile AB.

All material copyright 1991, SAAB Club of North America. Material may be reproduced with proper credit to the author and to "NINES, the SAAB Club Newsletter". The opinions and views expressed in articles are not necessarily those of the SAAB Club and its newsletter, NINES.

Editorial contributions are welcome. All material submitted is assumed to be for publication unless clearly labeled otherwise. Double-spaced typewritten articles are preferred, but most anything is acceptable. We cannot answer every inquiry and reserve the right to edit materials submitted.

Those wishing to submit articles or letters on 5 1/4" IBM-formatted disks, please convert to ASCII text files (<filename>.TXT). Please include a printed hard copy, and a SASE if you want the disk returned.

CHANGE OF ADDRESS: Eight weeks notice is required for change of address. Please send new address and old address, including zip codes, to the SAAB Club at the address above.

RETURNED CHECKS: There will be a fee of \$10.00 charged for checks returned for any reason.

If you study the map closely, you will see that Crystal Mountain isn't close to anything else. It is very important to make reservations and order your convention food package before July 5th. Due to distances involved, arranging extra food service for late comers will be impossible.

One final note: If you are planning to fly to the convention, American Airlines is offering a discount. Mention STAR FILE #S0471WE when you call American Airlines (1-800-433-1790) or your travel agent.

Rich Roberts
Bothell, Washington

Letters to NINES

Reminiscing

I want to congratulate you for what is probably the most enjoyable, entertaining and enlightening newsletter that I have ever received from the club. I couldn't put it down the day I received it and kept running out to the shop to read aloud some of the more humorous articles.

Ed Tonat's SAAB Club history brought back a lot of childhood memories since I lived near Harrisburg in the late fifties. My father bought his first SAAB in '58 from Harrisburg's Uptown Auto Sales. Phil Krantz was a good friend of my father and convinced him to test drive and eventually purchase a nifty 93B in black with red and black plaid upholstery. Phil eventually worked for Saab-Scania in various zones throughout the United States. He was instrumental in establishing SAAB in our area. If I remember correctly, he helped get the "club" started. Later, Sam and John Gingrich opened Gingrich SAAB Sales in an old custard stand in Harrisburg and ran the dealership and the club. They were always into racing SAABs and sponsored many autocrosses at the State Farmshow Building parking lot.

I guess that by learning to drive in a '63 95 when I turned sixteen has a lot to do with the fact that I just don't like driving anything but SAABs. For that matter, my romance blossomed and became Parrformance, exclusively SAAB, and proud of it!

So from one SAAB fanatic to all the rest of you out there, thanks for all your contributions to the newsletter, the conventions and all the other activities that make SAABing the best way to go!

Rick Parr
Parrformance
Lititz PA

The big Feb/Mar issue came out quite well. I did enjoy the piece on Wee Erik, as I met him a number of times when I had Pacific Motor Imports in San Luis Obispo (1967-73) and rode with him once in Sweden on a dealer tour of Scandinavia (1969). It was at a time when I was doing

autocrosses and rallies and I was particularly keen on what to do with a front driver on loose surfaces, having approached that subject rather cautiously, not wanting to destroy a rally car in the learning process. It was apparent from the ride around the forest test track (a one-lane, bulldozed-through-forest trail with gravel thrown on top of it -- good test track, minimum expense, typical of the Swedes) that I was doing all the right things. I was just doing them LATER and going a lot SLOWER than the Wee Swede.

Thus emboldened, I did screw up my brave quotient and tried going a good lot faster in the loose, and as a result was able to post some speeds that rather astounded my competitors in SCCA and 4-Cylinder Club rally events, using 96s, Sonetts and later, the Fiat 128SL Coupe, which I still consider to be the best handling front-wheel drive car ever built to this day. Not as fast as my Sonetts in top speed (110 was it) but the handling -- particularly in the loose surface environment -- was leagues better.

Jack Ashcraft
Medford OR

A New 96

I thought club members would be interested in the new Saab that I purchased recently -- a 96! That's right, brand new! [The odometer shows 2171 miles.]

The Saab dealer in Syracuse, New York never sold it until this past fall. It was like going back in time to be able to buy the new 96 that I was never able to buy when they were still being imported. It's too bad that I didn't have it for last year's convention in Massachusetts.

Ron Raymond
Munnsville NY



Lowest Prices on new Saabs.

Get your best price then call us!

507/373-2471

1990 900T Convertible, Demo
1987 900 Turbo Convertible
1964 SAAB 96, low miles
1981 Fiat Spyder, 12,000 miles

Parts discount for
SAAB Club members
Visa/MasterCard

Bob Adams Imports
Saab/Mazda
2004 E. Main
Albert Lea, Minn. 56007

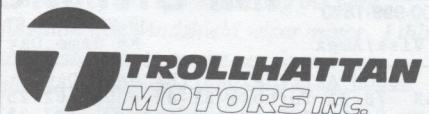

SPECIALIZING IN PARTS & SERVICE FOR SAAB & VOLVO

- OEM, OE & AFTERMARKET PARTS AVAILABLE
- REBUILT MANUAL TRANSMISSIONS AVAIL.
- PARTS DISCOUNTS UP TO 50% OFF LIST PRICE
- EVENING & SAT. HOURS

CALL FOR MONTHLY SPECIALS
1-800-32TROLL

301-682-4688
BALTIMORE, MD

INFO. & TECHNICAL ASSISTANCE AVAIL.

ORDERS SHIPPED WITHIN 24 HRS.

COD, VISA/MASTERCARD ACCEPTED.

**SAAB
VOLVO**

Exclusive
SAAB
Parts Center
The area's most extensive inventory at competitive discounts
(215) 886-8660
 Free delivery locally or Standard UPS



Exclusively SAAB since 1958
 1125-35 Easton Road • Abington, PA 19001
 Facsimile (215) 572-5030

Safest Sedan? Saab!

The Insurance Institute for Highway Safety (IIHS) recently released its findings on the chances of becoming a traffic fatality in 134 car models. Saab's 900 4-door was the highest rated sedan, second best of all cars in the study. The 900 sedan was involved in 0.6 fatalities per 10,000 registered cars. The study covered 1984 through 1988 model years.

Only the Volvo 240 station wagon was rated safer, at 0.5 fatalities per 10,000 cars, and the Volkswagen Vanagon tied with the Saab a 0.6. Other highly rated models: Oldsmobile Cutlass Cruiser, Pontiac Safari/Parisienne, Volvo 740/760 4-door, 0.7; Mercury Grand Marquis, Honda Accord 2-door, Acura Legend 4-door, 0.8.

The least safe cars according to the IIHS survey were the Chevrolet Corvette at 4.7 fatalities per 10,000 cars, followed by the Chevrolet Sprint 4-door at 4.5. Other unsafe cars: Chevrolet Sprint 2-door, Chevrolet Camaro, and Ford Mustang, 4.3; Ford Mustang Convertible and Nissan 300ZX, 4.0; Yugo 2-door, 3.6; Chevrolet Spectrum

and Pontiac Fiero, 3.5.

Ratings of Saab's 9000 models and 900 3-door were not listed in preliminary releases by the IIHS.

Canadian dealers sue

Fifteen former Saab dealers have sued over the loss of their franchises last year. The dealers claim that Saab-Scania Canada requested early in 1990 that they improve their dealerships. The assumption was that they would continue to sell new Saabs.

On May 1, 1990, GM of Canada announced that new Saabs would be sold through its Passport International Automobiles Division. Saab-Scania of Canada was shut down later in the year and the 32 Saab dealerships in Canada were terminated. Though the dealers were given the opportunity to become Passport dealers, only one has done so.

Defendants are General Motors, GM of Canada, Saab-Scania Canada and Saab Automobile AB. Saab Automobile was formed when GM Europe purchased 50 percent of the Saab Car Division in 1990.

Orders Only \$25.00 Minimum 1-800-999-1820 MC/Visa/Amex		IMPORT MOTOR PARTS	Information & Technical Help 1-719-542-7025
110 WEST 12TH ST., PUEBLO, CO 81003 ** Same Day Shipping **			
BOSCH ALTERNATORS (EXCHANGED)		BOSCH WARMUP REGULATORS	
AL35X 78-83 Turbo & 81-83 900s	162.25	40013 1975 99 All	134.94
AL36X 5/78-80 99 Non Turbo	147.35	40020 76-80 99,900 Non Tbo	85.86
AL69X 85-86 900T,86 9000 Turbo	204.95	40032 76-80 99,900 Calif cars	106.22
AL95X 67-74 95,96, Sonett	68.15	40051 78-80 All Tbos.	106.22
AL96X 74-4/78 99	102.25	40084 81-83 900 & Tbos.	179.95
AL112X 79-80 900 Non Turbo	103.35	40136 84-86 900 & Tbos.	110.82
AL128X 84-85 900 Non Turbo	186.95	BOSCH FILTERS	
BOSCH FUEL PUMPS		05005 Fuel 75-77 99	14.57
GFP202 82-86 900,82-84 Turbo	225.06	05021 Fuel 78-79 99,900 & Tbos	10.96
GFP213 75-81 99,900, & Turbo	169.95	05401 Fuel 80-4/85 900,Turbo	15.12
GFP270 69-74 99E,99 EMS	135.86	05601 Fuel 5/85-86 900,16V,&Tbo	16.58
GFP288 1985 900 Turbo 16V	143.88	72101 Oil 67-88 Saab All	3.71
GFP294 86 900 16v,9000 Turbo	167.04	73228 Air 75-86 2.0 exc 16V	5.50
BOSCH STARTERS (EXCHANGED)		BOSCH IGNITION PARTS	
SR32X 85-87 900,9000 & Turbos	214.45	00044 12 Volt Universal	14.23
SR77X 70-74 99	86.30	03010 Dist Cap - Most Saabs	5.18
SR78X 75-84 99,900 & Turbos	93.45	04038 Rotor 78-80 99,900 Tbo.	4.55
SR79X 69-73 95,96&71-74Sonett	83.55	04125 Rotor 1981 900,Turbo	6.27
SR80X 67-68 95,96&68-70Sonett	87.95	04144 Rotor 82-85 900T;82-87 900	7.80
IGNITION CONTROL UNITS		04168 Rotor 1985 900	9.52
00014 99,900 78-81	232.13	09105 Wires 72-80 All 99s,900s	12.95
00139 900 82-84	109.01	09106 Wires 81-87 900,900 Turbos	12.95
BOSCH LAMBDA SENSORS		BOSCH MISCELLANEOUS ITEMS	
01051 77-86 1 Wire	38.95	Non Resistor Spark Plugs	1.32
03006 86 900 16V	112.46	Resistor Super Spark Plugs	1.50
03009 84-4/85 900 Turbo 16V	134.33	Platinum Resistor Spark Plugs	2.48
03028 5/85-on All Turbo 16V	144.07	MicroEdgell Wiper Blade 10"-16"	4.84
BOSCH IDLE SPEED REGULATORS		MicroEdgell Wiper Blade 17"-20"	6.19
40502 85-86 16V	134.94	MicroEdgell Refills	4.78
BOSCH FUEL INJECTORS		TIMING BELTS & PIECES	
50045 71-74 99 All 1.7,2.0	35.62	7500697 Chain 85on 16Vs	28.69
02004 75-80 99,900 Exc 78 99T	20.81	7871403 Chain 73-80 99,900	29.75
02012 81-86 900 All 8 Valve	22.50	8346785 Crank Gear 73-80 99,900	37.95
BOSCH COLD START VALVES		8346793 Idler Gear 73-80 99,900	34.95
70401 75-80 All	35.94	8346801 Cam Gear 73-80 99,900	41.25
70406 81-86 All 8 Valve	42.69	8347874 Tensioner 73-80 99,900	26.65
CONSTANT VELOCITY JOINTS		8817405 Tensioner 81-88 900 8V	19.98
8921728 75-80 99,900 Outer Jnt	137.95	9359779 Chain 81-88 900 8V	19.98
8942633 81-85 900 Outer Joint	137.95	COUNTERSHAFT	
8945735 69-84 All Inner Tripod	49.95	8358509 73-80 99;79-80 900 2.0	225.00
		RADIATORS & WATER PUMPS	
		7540503 Radiator 1977-80 99s	175.00
		7541063 Radiator 79on 900s	179.95
		7541071 Radiator 79on 900 Tbo	169.95
		8358491 Pump 75-76 99 12 Cog	69.95
		8367674 Pump 77-80 99,900 (Kit)	79.95
		8389058 Pump 69-76 99 (Kit)	32.95
		8389751 Radiator 69-76 99s	189.95
		8814591 Pump 67-74 95,96,Sonett	29.95
		8817819 Radiator 78-80 99 Tbo	189.95
		8817900 Pump 81-88 900 8 Valves	36.95
		9382649 Radiator 86on 9000 5sp	297.00
		MUFFLERS	
		7282007 67-73 95,96 V4s	Front 39.95
		7533631 69-88 All 8V NonT	Rear 39.90
		8838005 67-73 95,96 V4s	Rear 31.39
		9326463 81-83 900 Turbos	Rear 63.35
		9349143 86on 900 NonT 16V	Center 69.50
		9349176 1986 900	Rear 65.95
		9349192 84on 900 Turbos	Rear 82.89
		9361817 1979 900 exc CA	Front 49.99
		9365511 78-80 99 Turbo	Rear 63.98
		POWER STEERING RACKS	
		26 980 79&on 900s (Short)	179.95
		26 1980 79&on 900s (Long Rack)	229.95
		REPCO METALMASTER PADS	
		111M 76&on 99,900s (Rear)	21.95
		226M 99,900 Front Brake Pads	21.95
		KYB GAS-A-JUST SHOCKS	
		Lifetime Warranty for most Import and American cars including Saab 21.95 ea	
		KONI SHOCKS	
		Adjustable Shock (most Saabs) 58.95 ea	
		BILSTEIN SHOCKS	
		HD Setting for 900 8 valves 66.85 ea	
		MISCELLANEOUS ITEMS	
		0260257 Wind Deflector 900s	47.50
		8307498 Cltch Disc 99,900 4sp NT	34.95
		8704116 Cltch Cover 99,900 NonT	39.95
		8722209 Cltch Slave Cyl 76-85	79.95
		8904575 Brake Disc 69-74 99 F&R	36.95
		8939589 Front Caliper 75-85 All	199.80
		8941981 Frt Brake Rotor 81on 900	36.95
		8944977 Clutch Master Cyl 79-85	66.15
		8948127 Master Cyl 75-85 All	138.25
		8985384 Ball Joints 99,900	22.95
		9746322 900 Heater Control Valve	80.95

Doktor Nio's SAAB Klinik

Submit your questions with as complete information on the problem as possible, also giving the year and model of SAAB. Problems of general interest will be answered here. No requests for personal replies please. Questions which would require modification of, or would defeat Federally required emissions systems will not be answered. For a proper diagnosis, it is recommended that you contact an authorized SAAB dealer or repair shop.

Send your questions to: SAAB KLINIK, 2416 London Road, Unit 900, Duluth, MN 55812-2221

Can you help by recommending some replacement parts for my '66 96 stroker?

1) I once replaced the exhaust supports with some GM air conditioner isolation mounts that worked better than OE. The part number was in the newsletter years ago, but I have lost it.

2) The wiper arms are wimpy. Is there a replacement that will put more pressure on the blade?

3) There is more body-roll than I remember having years ago. Do I need new springs, new/bigger stabilizer bar, or stiffer shocks?

Vilis Ozolins
Crowley Lake CA

1) *The exhaust mounts we use are like the OE mounts and do not transmit noise and vibration to the body. I'm not familiar with the GM mounts you refer to but I can recommend early Volvo and SAAB EFI fuel pump mounts as an alternative. Renault R5s used a heavier hanger as well.*

2) *Years ago Trico and Anco had splined hub adapters to fit on VW wiper pivots so you could install heavier arms and blades. If you can find some at an auto parts house, they'll fit your 96 too.*

3) *I'm prone to say the springs, especially the rears, are weak. It seems front-heavy cars body lean is best controlled with rear roll stiffness.*

Recently I picked up a 1970 96 V4. Being the environmentally conscious sort, can I run it on unleaded fuel without damaging the engine?

Robin MacDuffie
Oakland CA

Unleaded fuel is known to lessen the life of non-hardened valve seats in older engines. Adding some leaded fuel occasionally will help control wear. Jack Ashcraft (503/779-0731) offers V4 heads with stellite hardened seats already installed. They would be your best alternative.

I own a 1987 9000 Turbo (5-speed) which I purchased used with about 31,000 miles on it. When the throttle is closed the RPM drops well below idle speed, 400-500 RPM, and the engine shudders on the verge

of stall. I am not sure this behavior is healthy for the bearings, and it severely hampers driveability in stop and go traffic.

Will Assad

This looks like it will be an ongoing problem for any early A/C (automatic idle control) engine. A few months back I listed a few things to check.

The intake system and throttle plate should be de-gunked and cleaned. Unplug the throttle position switch and put a jumper wire between pins 1 and 2 to simulate a closed throttle. On the cowl, locate the test plugs at the left hood hinge. There will be one female spade socket by itself. Insert a jumper wire and ground the other end on the body. This will cut the A/C out of the system to allow you to set basic idle.

Start the engine and turn all accessories off including the climate control. Adjust the basic idle to 850 RPM by loosening the throttle stop locknut and turning the screw. Retighten the locknut once you have 850 to 900 RPM. Shut the engine off.

Remove both jumpers and plug the throttle switch in again. Double check the throttle switch adjustment by cracking the throttle and listening for a click just off closed. If the click is not apparent, loosen the two screws holding the switch and rotate it until you do. Start the engine again and adjust the contact pressure of the deceleration dashpot so it dampens the throttle lever as the throttle snaps closed. Note how quickly the idle responds to the A/C compressor clutch engaging. If the reaction is slow, the A/C valve is at fault and would have to be replaced.

I hesitate to get this technical here and would rather see the operation performed by a qualified technician, but I think I simplified the procedure enough that you should be successful.

I own a 1988 9000 Turbo bought new. The mileage is 42,000 and the engine is in a good state of tune.

1) During cold starts, and especially when the air temp is above 60°F, the engine's idle is not steady. When the clutch is engaged while driving at any speed, the RPM will drop below 850 (to about 500

RPM), the engine will shudder for a second then it catches itself and raises back to 850.

2) A while ago the local dealer remedied my rattling sunroof. After that fix, the roof would not always find its closed position. It would go from open, past closed to the pop-up position without stopping.

3) The front brake calipers seem to be rattling. This is only noticed at slow speeds. The culprit seems to be the rubber grommets that insulate the mounting allen-head studs which hold the caliper to the main brake/steering component.

4) When the car is warm from stop-and-go driving, the clutch will growl or groan upon release.

Robert Prosser
Carlsbad CA

1) *Please refer to the previous letter.*

2) *I would guess the problem is in the cam and contact wheel of the motor gear. It might be out of sync with the toothed cable. It's kind of like synchronizing the park function in a windshield wiper motor. I think the dealer owes you the repair and you should request that they get it right.*

3) *The bushings, p/n 8969107 could be the culprit. Also check the wire springs that put pressure on the pad and caliper body, p/n 8969123.*

4) *Unless you are hearing the clutch disc shriek as it engages, in all probability the release bearing is dry and will need replacement soon.*

I have some questions regarding Red Line MTL. With a rating of 75W-80W is it advisable to use this product during harsh Northern Vermont winters?

I have been unable to find an auto parts dealer who carries Red Line MTL in the Burlington area. Can you tell me where MTL can be purchased in New England?

Roger Breton
So. Burlington VT

Red Line MTL has been well received by the SAAB owners who have tried it. If Tim Winker has been using it successfully in his cold climate, it must be fine for yours. Call Red Line at 1-800-624-7958 for a dealer near you, or they will sell it to you directly. (Also see their ad in this issue.)

SERVICE SUBJECTS



FROM SAAB

Correcting Water Leaks Into the Floor Area

Application: All 900 models
PSI 02/91-0086, Sec. 8/Pg. 16

Water leaks into the floor area of a 900 are often difficult to solve because there are several possible points of entry. This PSI presents a diagnostic procedure for determining the point(s) of entry as well as repair procedures for rectifying some of the possible causes of wet carpets and floors. Water leaks around doors and windows are, in most cases, easily diagnosed and are not covered in this PSI.

Determining the Point of Entry

1. Remove the seats, the center console, the carpets and the foam padding under the carpets.
2. Temporarily replace the three screws on each side of the carpet trim pieces along the front of the door openings.
3. Hang the carpets and padding up to dry. Wet carpets and padding will not dry completely if left in the car.
4. Dry off the floor of the car and close the doors, windows and sunroof (if equipped).
5. Direct water onto the sunroof area, the windshield and the cowl gutter ahead of the windshield (beneath the rear edge of the hood). Water testing is most effective if carried out by standing outside the car and observing the accumulation of water through the windows. Note carefully where the water is coming from.

Possible Points of Entry and Repair Procedures

1. Fuse panel/firewall connection (Fig. 1). Install a new seal, P/N 85 52 671 and additional body putty as necessary.
2. Wiring harness entry at the bottom of the right side A-pillar (Figure 0086-2).

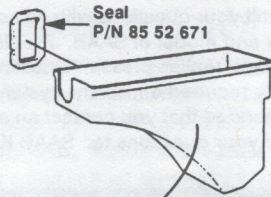

Figure 0086-1 Install a new seal and additional body putty as necessary.

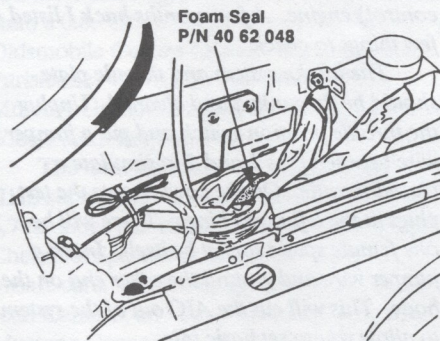

Figure 0086-2 Check that there is a foam seal in the grommet and that it is correctly positioned.

- Make sure there is a foam seal, P/N 40 62 048, in the grommet and that it is correctly positioned. Also check the integrity of the grommet and the tightness of the cable tie. Correct as necessary.
3. **Evaporator housing seal.**
Check the position of the water tray and seal. Correct as necessary.
 4. **Body sill panels.**
 - a. Seal possible entry points and install the additional drain plug as specified in SI 05/90-1238. One frequently overlooked place that water can leak into the sill area is a small gap located in the sill just below the leading edge of the front door (Figure 0086-3). This

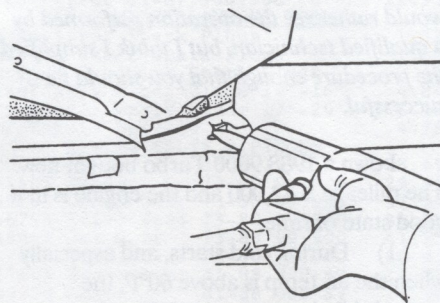

Figure 0086-3 Seal any gap located between the sill and the lower end of the A-pillar.

Saab Parts and Service Information updates are provided to NINES as a courtesy to Saab owners by Daniel L. David, director service and technical, and Sten O. Helling, President of Saab Cars USA, Inc.

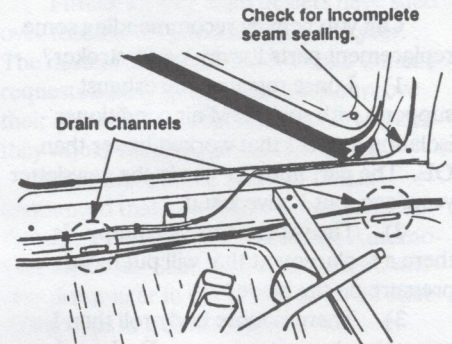

Figure 0086-4 Seal the four small drain channels with 3M strip caulk.

- gap can exist because of incomplete seam sealing, either from original production or from collision repair. Gaps in any body seam should be sealed using 3M All-Around Autobody Sealant (-08500).
- b. There are also four small drain channels, two on each side (Figure 0086-4) which can allow water to drain from the sills into the floor area. Water which enters the sill is supposed to exit the car via the front and rear rubber drains. Depending on the angle of the car when parked, this does not always happen. Seal these channels with 3M strip caulk.

Revised Maintenance Schedule for Oxygen Sensor Replacement

Application: All 900 and 9000 models with LH 2.4 Fuel System, 1988-1989.
PSI 02/91-0088, Sec. 1/Pg. 7

Beginning with the 1990 model year, the oxygen sensor was removed from the list of regularly replaced parts for all major services (60,000 miles, 120,000 miles, etc.). The oxygen sensor used in these vehicles is the special pre-heated type (Figure 0088-1) and the fuel injection systems incorporate an oxygen sensor malfunction detection and warning indication system.

1988 and later models with the LH 2.4 fuel injection system are also equipped with this same oxygen sensor design and fault

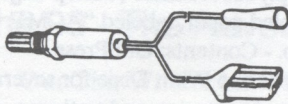

Figure 0088-1 Pre-heated oxygen sensor.

indication capability. Our experience has shown that the maintenance schedule from 1990 and later models can be applied to these earlier cars. For these reasons, the oxygen sensor is now deleted as a normal maintenance replacement part at the 60,000 and 120,000 mile major services for 1988-89 models with LH 2.4 (see chart below).

Posters and service merchandising material produced by Saab Cars USA, Inc. from this point on will reflect this change in recommended maintenance. Owners should also be counseled that this change, while contrary to information in their Owner's Manual and Warranties & Service Record Booklet, has been fully approved by Saab and will result in lower maintenance cost without any detrimental effects on vehicle performance or reliability.

Sensor Replacement Determination

The LH 2.4 fuel system includes programming which will detect a failed sensor, therefore an oxygen sensor need only be replaced when the LH system indicates a failure. Should the CHECK ENGINE light illuminate, the fault code(s) should be retrieved by the technician and the appropriate fault tracing performed to determine if a faulty sensor is indicated. If the fault is confirmed to be the oxygen sensor, then it should be replaced.

NOTE

Maintenance recommendations for all 900's with 8-valve engines (CIS fuel injection) and 16-valve models with LH 2.2 (including 1988 Turbos) are not affected by this change, regardless of whether they have the pre-heated oxygen sensor design. These models lack the fault indication capability and therefore the oxygen sensor must continue to be replaced at specified intervals.

	900	900S	900T	9000S	9000T
1988		X		X	
1989	X	X	X	X	X

Figure 0088-2 Models with LH 2.4 fuel injection

SAAB NEWS

Sales up, Saab extends special finance program

While other car companies sales continue to drop, Saab sales have recovered somewhat. Saab's special retail finance and leasing programs contributed to sales of 3,746 units during the month of March, an increase of 65.2% compared to the same month last year. Year to date, Saab has posted a 4.1% sales increase in comparison to the first three months of 1990. As a result, Saab Cars USA, Inc. has extended their special finance programs through April 30, 1991.

According to William S. Kelly, vice president, sales & marketing, "With today's trend toward more value oriented purchases, the special Saab retail finance and lease programs represent an extremely cost-effective way to get behind the wheel of a new Saab 9000 or Saab 900."

Saab's Financial Services Corp. is offering the lowest retail finance rates in its history. Financing for 1991 900 models is available at 2.15% for 24, 36, or 48 month terms, while new 9000s may be financed at 4.35% for 24, 36, or 48 months. The special finance rates require a 20% down payment.

Through Saab's special finance program, a '91 Saab 900 hatchback (manual transmission) may be purchased for \$299 monthly payments for 48 months, while a 1991 Saab 9000 hatchback (manual transmission) could be yours for 48 monthly payments of \$399.

Saab is also offering attractive lease rates for all 1991 models, with no money down. These special rates translate, for example, to \$299 monthly payments for 36 months on a Saab 900, and \$399 monthly payments for 36 months on a Saab 9000. Terms for 24 and 48 months are also available.

All 1991 Saabs are backed by a 6 year/80,000 mile new car warranty, with bumper-to-bumper coverage for 3 years/40,000 miles and major systems coverage for the duration of the warranty period.

Both programs are subject to model availability.

Saab aims for Far East sales

With sagging sales in its primary markets -- Scandinavia, Britain and the United States -- Saab Automobile AB is turning its attention to the Far Eastern markets. Saab sold 6,000 new cars in the Far East last year, and David J. Herman, Saab's president, hopes to double that within three years.

Singapore, Taiwan, Hong Kong and Japan are all potential growth markets for Saab. European marques such as Mercedes and Volvo tend to dominate those markets. Saab already outsells Volvo in Hong Kong.

3,000 new Saabs were sold in Japan in 1990. Herman says that Saab should be able to reach 10,000 units in that country in the foreseeable future.

Lotus-Saab?

Lotus has often been called on to breathe extra life into some fine automobiles. Witness the current Limited Edition Lotus Omega and Lotus Carlton, available only in Europe. Several Isuzu models and the Corvette ZR-1 have benefitted from suspension work by Lotus. Don't forget the popular Lotus Cortina of the 1960s.

As you should know, General Motors owns Group Lotus and half of Saab Automobile AB. Saab's president, David Herman, let it be known at the Geneva Auto Show that special Lotus editions of Saab may be built to serve performance niche markets.

Saab's 16-valve engine is already admired throughout the auto industry. Imagine further development of that engine or Saab suspensions under the guidance of Lotus!

1-800-582-SAAB: Toll-free number for customer inquiries

Saab Cars USA, Inc. has made it easier to acquire information on new Saab 900s and 9000s. By dialing a toll-free phone number, 1-800-582-SAAB (-7222), people seeking information on new Saabs can receive complimentary Saab 9000 or Saab 900 brochures, the location of their nearest Saab dealer(s), and other related Saab product information.



Stuffed 9000!

Ingredients:

- One 1991 Saab 9000 5-door
- One elderly aunt with lots of luggage
- Six bags of groceries
- Three bags of fertilizer
- One computer system, in boxes
- One sail bag
- One large painting
- One pallet of flowers
- One whining child with tuba
- One large dog
- One grandfather clock

Directions: Take a group of newspaper journalists, put them into several Saab 9000s. Send them on a "Real World Rally" around the town of Fairhope, Alabama. The object is to go through the motions of usual weekend chores and see how much the Saab 9000 5-door can hold.

The purpose of the whole event was to introduce said media persons to Saab's new "entry level" 9000. Priced at \$22,895, the newest 9000 is certainly not entry level for most folks, but more an entry level luxury car. That price is nestled between the 900S 3- and 4-door models, which gives Saab fans looking for a newer model, or a five door, a chance to sample Saab's current technology.

The base model 9000 is more utilitarian than the 9000S or 9000 Turbo models with velour seating instead of leather, steel wheels instead of alloys, and deleted are the sunroof, cruise control, fog lights and sound system equalizer. It is still very much a luxury machine with Saab's naturally aspirated 2.3 liter engine (at 150hp), Saab

Direct Ignition, anti-lock brakes, driver's side air bag, air conditioning, central locking, power windows, heated front seats, and the other 9000 attributes. Like the 9000S it has the simpler dial-type heating and ventilation controls, not the Automatic Climate Control system which is now reserved for the Turbo and CD Turbo.

During a get-acquainted pre-rally gathering, I teamed up with Jim Motavalli, who writes for the Advocate newspapers in Connecticut. Jim has a particular fondness for that other Swedish car, and owns a couple of 122s and an 1800.

So we took a drive through southern Alabama, pausing for lunch in Fairhope. From there the Saab group was very much in evidence as the dozen or so 9000s cruised back and forth through the town on their appointed errands. With three different assigned routes, the Fairhope residents who participated were kept busy much of the afternoon.

Our route took us first to the Fairhope Municipal Airport, where we were to pick up Aunt Purnie and here luggage. There were actually several Aunt Purnies, with real names like Ruby and MoDean.

Since this was a timed rally, the townsfolk had been instructed to try to delay the competitors. Our Aunt Purnie did a great job, first complaining about our late arrival, then pausing to say long goodbyes to her fellow travelers, taking her time getting into the car, deciding she wanted something from her luggage... very much like picking up an ornery elderly relative.

After dropping Aunt Purnie at the Full Gospel Lighthouse Church (she was in town to participate in a gathering of church choirs

after all), it was off to the Old Tyme Feed & Garden Supply for fertilizer (burlap bags full of crumpled paper, labeled "ACME Fertilizer Co. - Contents: Old Press Releases"), then to Winn Dixie for several dummy bags of groceries, and to the computer store for a box of something computer related.

By now space in the 9000 was limited (besides they needed the props for the other two groups of rallyists), so we unloaded and set off for the next leg. The next round had us picking up a sail bag at the Fairhope Harbor Marina (Fairhope is on the eastern side of Mobile Bay), a painting at the Eastern Shore Art Center, and a tray of flowers at Klumpp's Garden Center.

After another emptying of the 9000, we collected another passenger -- Rachel, and her tuba. A stop at the Animal Clinic netted one large dog named Towser (stuffed), where he had allegedly gone for "detangling". At the Emperor Clock Company we added a grandfather clock to the booty.

Rachel was to be dropped off "for her tuba lesson" at Mrs. Tuttle's, where the sign read "Anyone can toot a flute, but it takes talent to tackle a Tuba!" Mrs. Tuttle, another plant of course, was in real life originally from Duluth, which made it easy to delay our crew as she reminisced about her life in that great inland port. As a result of that lengthy visit, Jim and I finished in a four-way tie for second place.

Since the purpose of this entire episode was to offer an evaluation of the entry-level 9000, allow me...

This car harkens back to Saab's roots. It offers safety, utility, economy, and sporty handling in one package, much like the 96 and 99 did in their day. It also adds the luxury touches which have become *de rigueur* in today's cars -- air conditioning, power windows, central locking, split rear seat, anti-lock brakes, air bag, etc. Add those to the price of a 99 or 96, multiply by the Consumer Price Index and the exchange rate, and you'll find the new 9000 comes out pretty close to what those earlier models would have to sell for today.

In recent months, Saab dealers have been making particularly good deals, and Saab is helping with special finance rates. The new lower-priced 9000 looked good before, but with these incentives, it is a true bargain! I have been very tempted to visit a dealer to add this 9000 to the SAAB Club stable. What are you waiting for?

Tim Winker

HISTORY OF THE THREE CYLINDER TWO STROKE

The 93 - The Adventure Begins — Copyright by Simon DuStroke

Our Tim Winker has written of the 92's history (Dec 89) and now I pick up the story with the first Saab to feature the earth shattering power of the Three Cylinder Two Stroke engine.

In March 1955 the sales slide of Saab's 92B was accelerated by DKW's introduction of their long awaited three-cylinder two stroke. By the early autumn, something special had to be done quickly as sales were now falling alarmingly. So, Sixten Sason, Saab's famous designer, showed the eager automotive press a sketch of the upcoming new Saab. It's not recorded what positive effect this was supposed to have, but the earth certainly moved on December 1, 1955. After a parade of the new 93's (maroon, beige, grey, and grey-green if you must know) through the city streets, the car was unveiled at the Philipsons showroom in downtown Stockholm. It was an instant hit.

Saab, with their second model ever, had started the tradition of remodeling only one end of the car at a time. Thus the new 93 looked like a 92B from the doors back. But the front! Naturally it was designed by Sason, but it was 'Italian-inspired' to give it what the brochure calls 'that oh so European look'. Beyond the beautiful 'Italian-inspired' hood, fenders and bumper were some real changes. The engine, which merits it's own article, was longitudinally mounted, instead of transversely as in the 92. This was partly to be rid of the nasty idle motions of the 92. There was a new gearbox to accommodate this change, a new 12 volt electrical system and, of course the first Saab ever with the now famous overhead fanshaft. Overhead fanshaft, you ask? Glad you did. The radiator was located between the engine and the passenger compartment. (As God intended, you nod.) But how to power the rad fan? The only easy power



The 93 is revealed to the press by Svante Holm, head of the Trollhattan factory

takeoff point was at the front of the engine. Solution: Run a shaft over the head, the whole length of the engine, with a fan on the rad end and a pulley on the other to be driven by a lengthened generator/waterpump belt. Presto, instant engineering legend, the overhead fanshaft.

The chassis also came in for some needed attention. The best of the 92 was retained, the rack and pinion steering, the famous column shifter and such. New was an all coil spring suspension and an increase in the front track of 40mm! (for you non-metric types that's about 1.5"). This gave the world the first car with the "wide track look". All this and wider rims (now a full 4") gave the 93 far better handling than the 92B.

That was just the beginning! In '57 seat belts were made an option, as was another neat gizmo, the Saxomatic Clutch. This is one of those seemingly brilliant ideas which reappears from time to time and never, ever sells very well. Basically it is an automatic

centrifugal clutch which eliminates the need for a clutch pedal.

In 1958 there were so many changes that the model was retagged the 93B. The major improvements included a one piece windshield, an armored cable from the ignition switch to the coil to prevent thefts, more seat adjustment, a self-mixing fuel tank and a three-percent oil mix.

The 93B was replaced about a year later by the 93F. The 'F' designation indicated that the doors were hinged from the front edge instead of being the 'suicide type' of all the previous models. Three new colors were the other major improvement in what was really only a stopgap model until the 96 was ready.

The 93 was a great success. Almost 53,000 of them were built with over 40% exported (mostly in the US) vs only 5% of the 92s.

Next Time: Saab Invades USA

Simon DuStroke

Lonnegren Remembers

(Len Lonnegren worked for Saab Motors, which later became Saab-Scania of America, from 1963 to 1989. Though his title changed several times, his job was primarily public relations.)

Dear Tim,

If you are correct -- and I am afraid you are -- when you say that 1991 marks the 35th anniversary of Saab's start in the United States, that means that those people who were involved at the beginning must be very old. And makes me thankful I wasn't one of them -- not by much anyhow. Those people, from Ralph Millet on down into the ranks were the real pioneers, and deserve the thanks of all us for starting the Saab wave in the US.

Actually, one of my own first Saab experiences sort of coincides with the Saab start in the US, but it did take place in Sweden. It was the first time I was back in my native country after I had left it to become a Connecticut journalist. In order to get around Stockholm I borrowed a car from friend of mine. And, guess what, he had a Saab -- a 93 with "suicide doors", as I recall. Boy did I learn to hate that car in only two weeks in Sweden. Twice it got me stuck in Stockholm traffic, and twice -- in only two weeks -- did it get involved in tangles with other vehicles, fortunately both instances rather slight ... but very annoying.

Especially the one where I was parking outside my mother's shop, and the driver of a dump truck, who had taken a wrong turn just ahead of me, decided to back up, without looking around.

You can understand that I wasn't all that excited about the product when eventually -- in 1963 to be exact -- I did join Saab Motors Inc., in New Haven, Connecticut.

After all, two years earlier I had saved enough money from free-lance writing for Swedish car magazines, to buy my first new car, and what I had bought was that "other Swedish" car, a 544, that I was immensely proud of. And now I had to change to something that was much different and smaller and made funny noises when you drove it, and that you also had to fill with a mixture of oil and gasoline. I hadn't liked that that time in Sweden, even though they had special pumps for mixed fuel there in those days. I knew they didn't have that in Connecticut, and driving with my wife to New Haven to pick up my first company car,

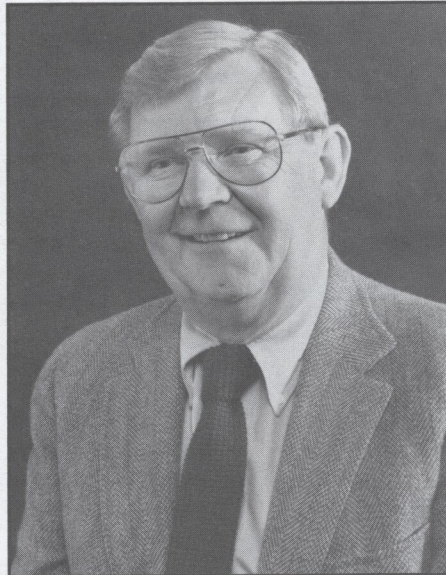

Len Lonnegren

we had a long discussion about how to handle this mixing business. Not until I got there did I learn about cans of two-stroke oil that miraculously fit right into a rack under the driver's seat, and that you only had to give to the gas station attendant to pour into the tank before he started pumping the gas. (Both I and many others ran into attendants in Connecticut who asked for the can of oil when we tried to fill a V4, and even a 99, as late as into the mid-'70s.)

Throughout the years, a number of people have been willing to take credit -- or do they mean blame? -- for getting me hired by Saab Motors. One of them is Mr. Saab himself, big Erik Carlsson, whom I first met at a Saab Owners' Open House on Waterfront Street in New Haven. I came there to write about Saab in the US for a Swedish magazine, and ended up talking with both Erik and Sten Wennlo, then PR manager for Saab-ANA in Sweden and later head of the Saab Car Division, about the possibility of working for Saab. Before I got a chance to talk to them, though, I had to sit through their talk about adventures that Erik had had in his many starts in the African Safari Rally, the one big event that he never succeeded in winning although he was very close quite a few times. I still don't believe that monkeys actually rode along with him by hanging onto the windshield wiper arms...but then he can tell a pretty good story.

Erik and I have become quite close friends over the years, and have had a lot of fun traveling together, from that first time in

New Haven and a few years later in connection with the 1965 Monte Carlo Rallye, to trips from North Cape of Norway, to Leningrad, Prague, Baja California, and all the way to the top of Alaska, at Prudhoe Bay. Actually, we flew to Prudhoe Bay, rather than drive the Pipeline Highway, but then Erik is actually more of an aircraft fan than a car enthusiast, especially when it comes to World War II aircraft. That's why we had to make a detour the time we went to the Saab Club convention in Las Vegas -- a detour that took us to Harlingen, Texas, and the Confederate Air Force, one of the greatest collections of WW II aircraft anywhere in the world. Believe me, it wasn't my idea, although I sure enjoyed it. After all, I have learned from the Big Fellow through the years...

The first time I went to Sweden for Saab was in connection with the 1965 Monte Carlo Rally, and that's where I ran into an old boyhood friend at a pre-rally gathering. His name was Bjorn Karlstrom and he used to show me how to build model airplanes when we were kids. When we now met again, he asked me what I thought of the "new sports car"? I had no ideas of what he was talking about, and it was only when I later turned to Erik that I heard something -- very vague -- about Saab's plans for a sports car. That's right. It was eventually called the Sonett II, and only a few weeks after I had returned to the US were two prototypes shown to the press in Sweden. It was Bjorn Karlstrom's version that became Sonett II, while the other, Katarina, by Sixten Sason, was rejected for production, but is still available for all to see at the Saab Museum in Trollhattan.

When the first Sonett II appeared on American shores it was destined for the New York Auto show, and since I had responsibility for shows it fell upon me to drive it from New Haven to New York -- with a lot of people slowing down to see what kind of a strange car they were passing -- and then onto the second floor of the New York Coliseum. There, the rule is that union "car spotters" move the cars on the floor -- without any help from the exhibitors. When I explained that this was the only one of its kind in the country and that I wasn't about to let anyone behind the wheel, the car spotters were taken aback a bit. But then, we compromised: I steered it; they pushed. That first Sonett was white, if I am not totally mistaken, and I think by now at least half a dozen Sonett fans have told me

that they own that very car. (Fortunately I cannot recall the chassis number, to prove anyone right or wrong.)

Saab owners take a lot of pride in their cars, and always want to talk about them. But I think the one I met the very first time I drove to Philadelphia is still the most enthusiastic one I ever ran into. I had visited one of the country's earliest Saab dealers, Victor Hajj of Victor's Sports Cars and attended a Saab Club meeting, when I started home in my two-stroke 96. Driving across one of the Delaware River bridges, a Saab 93 came up alongside me and practically forced me to the side of the road -- on the middle of the bridge. When I realized that it was a friendly encounter I stopped, and we agreed to get off the bridge and meet at a somewhat safer location on the other side. The 93 driver had recognized my Connecticut dealer/distributor license plate, and wanted to show me his car. He explained that he was a salesman for house siding and needed a ladder in his travels. The only car that had enough space for his ladder was the Saab 93; with the rear seat out of the way, of course. And there on the side of the road, he proudly showed me how easily he could get his precious ladder in and out of the Saab.

Of course, my friend Carlsson is always running into Saab owners wherever he goes -- at times he has even found them on the side of the road during rallies, fortuitously with just the right kind of car to borrow parts from so he could finish the event. And if owners don't come to him, he has been wont to go find them. Like when we were about to show the APV system for the US press at Hilton Head, South Carolina. Since we had some spare time before the event started, he convinced me that we should go talk to Saab owners living in the area. You can imagine the consternation when a nice lady home -- and Saab -- owner comes to her front door and meets two people who want to borrow her car ... "to clean and polish it!!!" We did take good care of her car and cleaned it better than it had probably ever been cleaned before, but I'm not sure if the lady knows that most of the washing was done by the "father of the Saab Turbo", Swedish super engineer Per Gillbrand, or that the entire job was supervised by Mr. Saab himself.

Unfortunately we didn't find any Saab owners to help, or to get help from, when we were involved in the Baja 1000 back in 1969. I am sure a helpful Saab owner with

the parts to lend would have come in handy when Erik and co-driver Torsten Aman found themselves stuck half way down the Baja peninsula with a broken half-shaft. Mechanic Berndt "Malin" Melin was soon at their side, however, having borrowed a truck at the nearest checkpoint. He changed the part, and the Saab was soon on its way again -- until the next morning. As soon as we camp followers were airborne that morning we got word on the radio that our friends were stuck again. When Malin eventually got to them -- they weren't that close to a checkpoint this time -- he discovered that the other shaft had broken. By the time that was replaced and they started out again, Erik Carlsson was mad, and drove like it. But, alas, not fast enough to make up for all the lost time...even though movie star, and racer, James Garner after the race told some of us that he could never figure out how that fast little Saab always seemed to be passing him.

It was in connection with Baja that Erik earned what at least I think is his highest honor. He was being interviewed by a radio announcer in Los Angeles, when the radioman turned to me and asked me, seriously, how I like travelling around

America "with my father". Quite an honor, for Erik, I thought. Quite an insult, he thought. Maybe, we're both right: After all being mistaken for my father, seems to me, must be an honor; but being considered the dad of someone who is all of 29 days younger can, of course, be seen as an insult. He got even though, when we, many years later, were reconnoitering the route for the US press introduction of the Saab convertible. Late at night I checked us into a motel in central California, when the desk clerk asked if I was a member of the AARP, an organization that until then I had never heard of. Erik has never let me forget that group since then, nor that it was me they asked, and not him... By now we both qualify for AARP membership, although the word "retired" hardly fits Erik Carlsson, and probably never will...

You know, Tim, working for Saab Motors and its successor Saab-Scania of America, for almost 27 years had been quite an experience. But maybe, after all, I better stop now so that there's something left for that book about Saab that I have been threatening to write. Thanks for reminding me of the anniversary.

Len Lonnegren
Madison, CT

!! BRAND NEW SAAB GOODIES !!

At long last we have sway bars for the 9000! These bars are 1 inch diameter, front and rear. The set comes complete with PolyUrethane bushings and end links. A bolt-on upgrade, these will really reduce the body roll in your 9000. Unleash the full handling potential of your car for **just \$349!** We also have two new exhaust systems available for the 9000s. Both systems are complete from the converter back, or you can order just the rear section. The Non-Turbocharged system increases pipe diameter from 45mm to 60 mm, which is a 60% increase in flow by itself! Then we utilize a low restriction muffler for an additional 30% increase. **That's almost double the flow rate!** The bottom line on these systems is a fantastic increase in performance, an average increase of 2 MPG, and a rich, throaty engine sound. The new Turbo system uses our proven rear exhaust section, with the addition of a new front pipe and muffler. Both of these system are powder-coated for corrosion resistance, and made of the highest quality 14 gauge tubing. Turbo systems have dual chrome tips, and Non-Turbo systems have single chrome tips. Complete systems are very affordable at **just \$295**, and rear sections are \$155 for Turbo and \$175 for Non-Turbo.

We have used the Calloway/PVE modified APC boxes for a long time with good success. We are very proud to announce that we now have a brand new modification available. Our new box has all the upgrades of the previous units, **PLUS all the changes that SAAB has used in their famous "RED BOX"**. This brings boost in much sooner, Holds max boost longer and almost eliminates Turbo lag. Even better, we are offering all these changes at **NO COST INCREASE!** As an introductory offer, you can get the new boxes for **only \$250** until July 4th. Several dealers have put this box on their own cars, and can hardly believe the improvement! Start the fireworks early; enjoy a special skyrocket SAAB of your own!

GROUP 6 PERFORMANCE

4961 N. Calle Tobosa Tucson, AZ 85749 (602) 749-1809

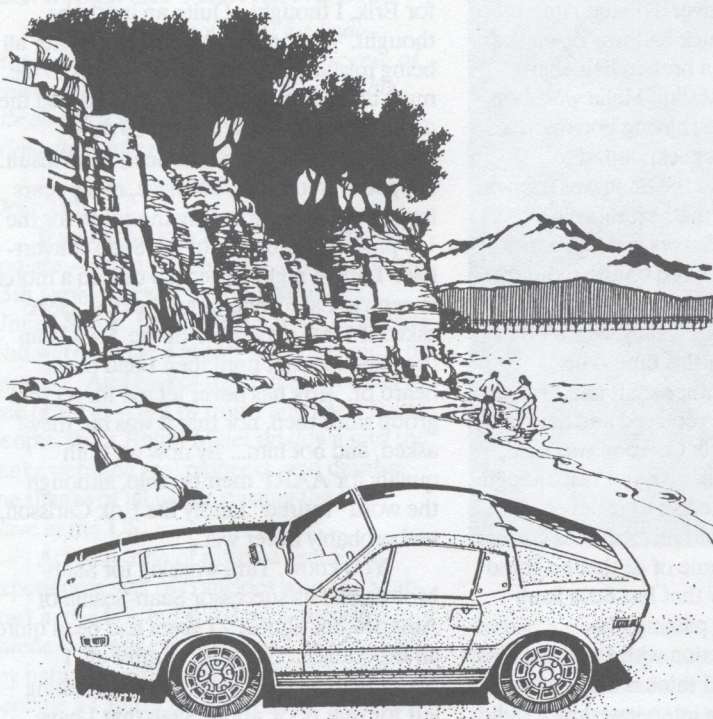

V4 SHIPPING CRATE

So you bought a V4 engine and don't know how to get it shipped? Send the seller this article. He can make up the simple crate shown out of 2x4s, 2x3s, some 3.5" nails, a piece of steel angle and 5 lag bolts. All the lumber up to the engine mounts is 2x4 stock. Note a short piece of scrap 3/4" plywood was used under the engine mounts to level the engine. The uprights are of 2x3 stock. The cross pieces at the top are 2x3 and these are lag screwed in place so they can be removed to make it easier to lift out the engine upon arrival.

The lag screws thru the engine mounts and the angle at the rear (which is bolted to the flywheel with a metric bolt) just keep the engine located in the crate during shipping.

Drain the oil before shipping. It's also a good idea to plug all the holes into the engine with plastic plugs to keep dust out during shipping. Finally, cover the whole mess with a heavy garbage bag or garden plastic and staple it in place. I also put a tag on



SHIFTIN' GEARS

by Jack Ashcraft

REPAIR RUSTY ROCKERS RIGHT

Well, Sonett fans, I finally got one. After years of hearing about Sonetts with rusty rocker panels I bought one with some losses apparent in the battle done with demon rust. It was apparent to me that the easiest way to fix this bugger was to develop a snap-on rocker panel that simply popped right on over the old one, was welded into place, and then primed and painted. So I did just that.

These snap-on rockers are now available for any Sonett and look EXACTLY like the originals, with the same facets down their length, etc. They can be torch, MIG or spot welded into place and with a modicum of skill the installer can make them look very nearly original. I say very nearly because I added an extra 4" of steel under the car, so the rocker extends that far out into the floor area. This is to get past the rust line on the floor where the rocker panel and the floor meet, so the person installing them has something to weld to.

I was surprised to see that Saab had used only 20 gauge steel for the original rockers. These new panels are 18 gauge and once properly installed, they really stiffen up the car. Once rust starts to eat away those rocker panels, you don't realize how close you are to having the car bend in the middle--the fiberglass body structure suddenly is a main structural member of the car and it was not designed with that in mind!

I did cut out some "windows" in the bottom of the old rockers so I could reach in there with a leather glove on and RUST MORT the entire inside of the old rocker panel before I installed the new panel. RUST MORT is good stuff and is bound to slow down the deterioration of the original panels. An ad for my rocker panels can be found elsewhere in this issue.

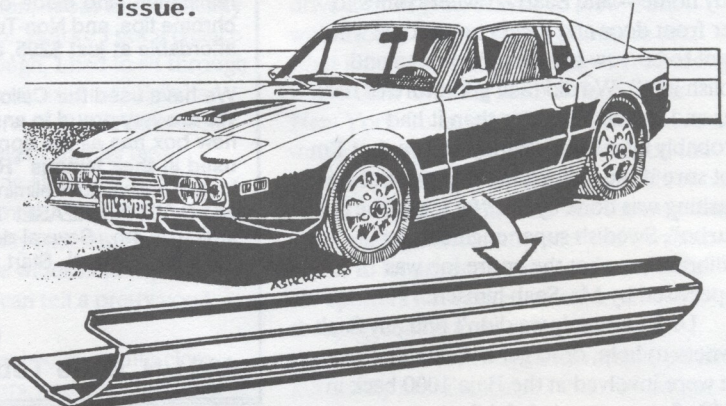

V4 SHIPPING CRATE, Cont'd:

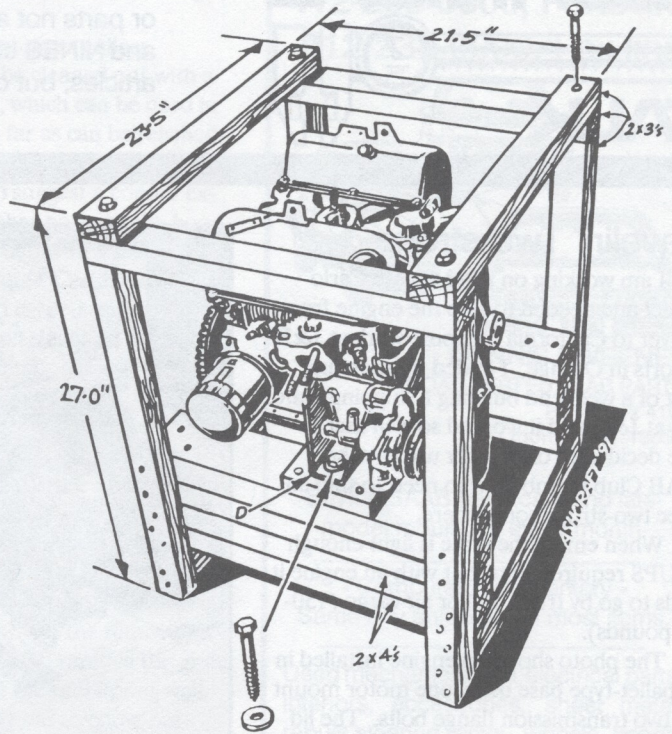
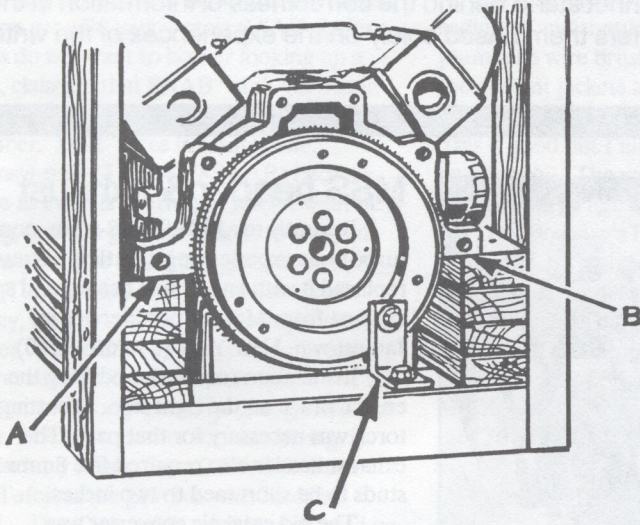

the engine inside the plastic telling the address of sender and recipient just in case the one outside gets lost.

This is a good way to ship the 280 lb V4 engine and the crate can be used any number of times unless the freight company destroys it during shipping.

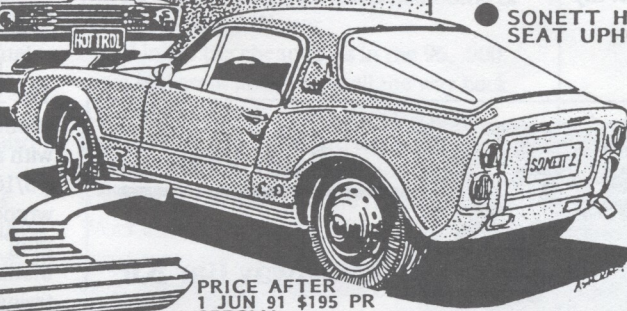
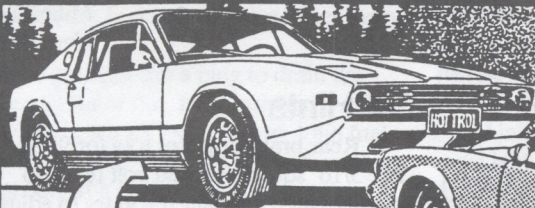

NEW!

● SONETT HARNESSES, SEAT UPHOLSTERY



NEW!

SONETT ROCKER PANELS!

PRICE AFTER 1 JUN 91 \$195 PR SPECIAL NOW ONLY **\$175**

PAIR, PLUS UPS

● WEATHERSTRIP KITS FOR 95, 96 & SONETT!

NEW "FINISHING TOUCH" CATALOG FOR SAAB 95, 96 & SONETT IS READY!

COVERS CARPETS, HEADLINERS, UPHOLSTERY, DASH TOP PADS, WEATHERSTRIP KITS, DRESS-UP ITEMS, V4 & SONETT, SHOP MANUALS, NEW BOOKS, THE SONETT ROCKER PANELS AND MORE!

only \$2

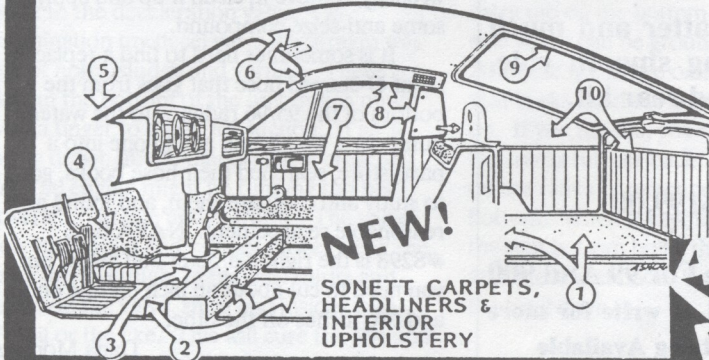

NEW!

SONETT CARPETS, HEADLINERS & INTERIOR UPHOLSTERY

4 PARTS

JACK ASHCRAFT AUTOMOTIVE DESIGN
2201 Woodlawn Drive, Medford, OR 97504
503-779-0731

TECHNICAL TALK

Technical articles written by subscribers may recommend procedures or parts not approved by Saab-Scania of America, Inc. The SAAB Club and NINES cannot stand behind the correctness of information in these articles, but offers them based solely on the experiences of the writers.

Travelin' Two-stroke

I am working on a '66 Monte Carlo project and needed to ship the engine from Denver to California for some work at J&B Imports in Orange. I ended up spending most of a weekend building a shipping crate. Bud at J&B said it worked so well that I have decided to offer it for use by other SAAB Club members who need to ship an 850cc two-stroke somewhere.

When empty the crate is light enough for UPS requirements, but with an engine it needs to go by truck, rail or air cargo (150-200 pounds).

The photo shows an engine installed in the pallet-type base using one motor mount and two transmission flange bolts. The lid totally encloses and protects the contents, and also provides two carry handles.

I am offering the crate to members at no charge (except shipping), but would like a \$50 deposit as motivation for returning it for the next potential user. I will deduct my

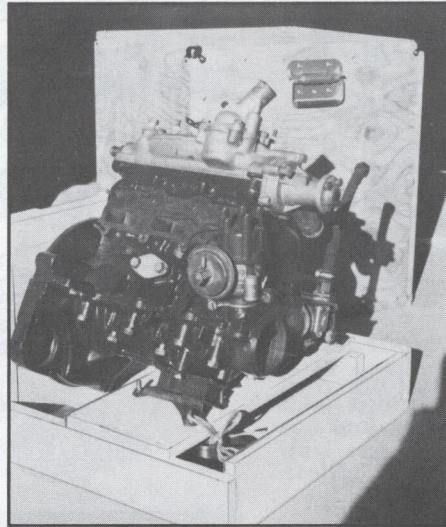

shipping costs from the deposit. My phone number is 303/526-9138.

Tom Nelson
P.O. Box 8025
El Rancho CO 80401

MSS header & exhaust

Recently my 1985 900 (8-valve, non-turbo) was experiencing a rattling exhaust. I replaced it with an exhaust header and sport exhaust from Motor Sport Service in Jamestown, New York (716/665-4200).

Installation required modifying the engine brace on the right side. A cutting torch was necessary for that part. The exhaust header also required five 8mmx1.25 studs to be shortened to two inches.

The old catalytic converter was seriously clogged after 98,000 miles, so I removed it. I plan to add an aftermarket converter later.

Performance is dramatically improved. The car is much stronger through all RPMs. The difference is particularly noticeable when accelerating from 55 to 70 quickly. Mileage is unchecked at this time.

Mike Tucker
Hartsville SC

V4 Hints

Rear brake adjuster tool for 95/96 V4. The 5/16" square-headed bolt tends to round easily, especially if you try to adjust it with a crescent wrench. Snap-On Tools has a 5/16" square socket to fit a 3/8" drive wrench. It is part number PP410 ("Pipe plug" socket). It costs nearly \$8 but has a lifetime warranty and it's cheaper than trying to replace a rounded brake adjuster.

When you do get the brake adjuster loose (use penetrating oil prior to applying wrench), remove it, clean it up and apply some anti-seize compound.

It is sometimes hard to find a replacement U-shaped hose that goes from the bottom of the 95/96 radiator to the water pump on a V4. I took an old one into a parts store, searched their hose books, got to study and compare them, and found a reasonable replacement. NAPA hose #8298 is the right diameter and angle, but you need to cut about an inch off one end and two inches off the other.

Dana Morong
Wiscasset ME

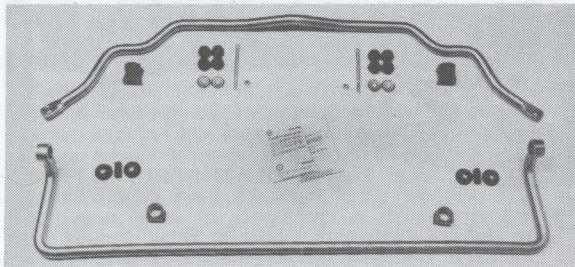

Saab 9000

Anti-sway Bar Kit

Now Available

This kit created by SAS for the 9000 delivers flatter and much improved cornering stability without sacrificing smooth ride. Upgrade your 9000 to this 1 inch (25mm) front and rear kit.

SAS

Swedish Auto Specialties
2820 N.E. Broadway
Portland, OR 97232
(503) 287-5204

Kit Price \$255.00
Nines SPECIAL \$199.00

Kits Also Available For 99 And 900
Questions? Please call or write for more information. Full Catalog Available

96 Upkeep

The 96 caveat is to replace life-limited parts just as one must on an airplane. I can always get a 96 part -- most SAAB dealerships do not want to bother looking up a part, claiming that SAAB "ain't got nuttin fuh dat caw" even if presented with a part number. I use Yates in Langhorne, Pennsylvania (1-800-669-SAAB) because Dave in Parts is courteous, knows what he is doing, and can get anything drop shipped overnight. The prices are great as well.

Tufoil, made by Fluoramics in New Jersey, works -- the engine runs quieter and cooler. I now drive faster so there is no appreciable difference in mileage, about 28 mpg (my 900 only got 25!). But gallons per hour, a better measure for city driving, is appreciably lower, from 2.2 to 2.0. I also use Tufoil in the gearbox with Redline MTL. The Taunus V4 torques real hard on a gearbox made for the older 2-stroke. It is macho to want horsepower, but I want longevity. So be easy on the gearbox, and use Tufoil to slow the excessive wear which the V4 creates.

Fuel pumps have a removable screen which should be inspected at oil change. I use any clear fuel filter, change it frequently, and renew the fuel and emissions lines every year.

The gas tank has a plug to drain the sludge and water out, but I installed a quick-drain valve from a Cessna 172 to drain fuel more often. You would be amazed at what drains out! If it is raining outside or the temperature drops suddenly, the water also condenses out of the tank's air space. It should be kept full if possible at night. If you must, use Isopropyl rather than Methyl-based "drygas": Methyl can be destructive to rubber parts and may loosen deposits that shouldn't be loosened.

Hot running in traffic, poor idle, frequent stalling but good acceleration, all point to the deceleration valve. On examination my decel valve diaphragm was full of holes, sludge and varnish. There is a hole in the bottom of the unit; reach under with a finger to check for suction. If air is being drawn in, the diaphragm is breached and the engine might be running too hot (overlean) at idle and in traffic. The valve gets stuck solid and will not move. Soak the assembly overnight in mineral spirits and lubricate the valve, stem and insides with Tufoil or the like. This will cure the idle and the engine will run cooler in stop-and-go

driving. My 96 passed emissions with large margin.

The metal coolant pipes collect sediment and should be cleaned out with a plumber's wire brush, which can be used in the coolant jackets as far as can be reached. Jack Ashcraft suggested a coolant filter. This is good but I also suggest a copper expansion coil. The washer ports on the hood can be cleared and aimed with a safety pin.

Dr. Bronner's Liquid Castile Soap cleans the interior and carpets and is biodegradable. Mineral oil cleans all exterior rubber, such as bumpers.

I built the improved radiator described by Jim Smart of Smart Motors in New Mexico, in a back issue of Nines, using a pre-'76 core from a 99 and the 96 end tanks, 900T flat fan (from the left side) and a 900T thermostitch mounted under the filler neck. The new radiator is much wider, so I removed the mountings and safety-wired the radiator permanently to the removable grille. It does mean that to remove the grille I must now disconnect the radiator as well, but the radiator usually has to come out anyway when removing the grille for engine access. The old fan and bearing is gone and the engine vibrates less: I took an old belt and cut it to the smaller size, then had it matched up at a parts store. For coolant, just 30% ethylene glycol and a half bottle of Redline's Water Wetter.

Unlike the cheap seats in the 96, 900 seats feel great and recline all the way back for those long trips. They fit like a glove into the 96. The tracks are the same distance apart, but you must use the 900 tracks, after cleaning off the track bottoms. Work slowly, you are experimenting -- the second seat will take only a quarter of the time. Use a pillar of washers on each bolt to raise the tracks about an inch, otherwise the seat adjustment lever will not clear the floor, and the seat will be too low. There is an extra tab on the bottom of the lever on one side which can be ground off for clearance. After the tracks are on loosely, unbolt the seat backs from the bottoms and try them on. If you are tall, you may want to mount the tracks further back. Everything depends on the range of movement of the seat bottom. When everything is right, tighten the seat bottom bolts, then the track bolts, attach the seat backs, and make a date for the local drive-in.

Robert Wagner
Manorville, NY

412-238-0900, Parts line
412-238-0099, Fax line

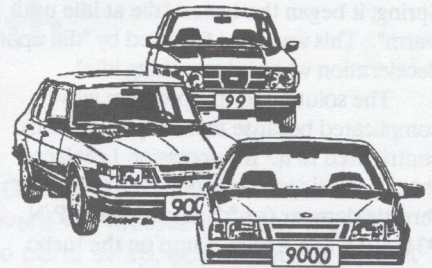

DENNIS SWEENEY
ROAD TESTED SAAB PARTS
RD 1, Box 410,
Ligonier, PA 15658

Buying SAAB parts cars and late-model rebuilders every month.

- Computerized inventory -
Same day shipping on most items.

Used mechanical and electrical parts, interiors, accessories, sheet metal, rebuilt steering racks, wheels, heads, transmissions.

Specialty Car Care Products

ZYMÖL

ZYMÖL is a non-abrasive car care system, using all natural ingredients.

Cream Wax (For Light colors)	8oz.	\$35.00
Carbon Wax (For Dark colors)	8oz.	\$35.00
Saab Wax (For all Saabs)	8oz.	\$35.00
Japan Wax (Cars manufactured in Japan)	8oz.	\$35.00
H-D Cleanse (Use before Wax)	8oz.	\$15.00
Brite (wheel cleaner)	8oz.	\$15.00
Strike (Removes oil & grease)	8oz.	\$20.00
Treat (leather conditioner & treatment)	8oz.	\$15.00
Vinyl (Vinyl & Rubber trim)	8oz.	\$15.00
Clear (car wash)	8oz.	\$15.00

ZYMÖL Starter Kit - Includes wax (specify), 8 oz. H-D Cleanse, 8 oz. Clear, Car Care Booklet, Towel, Applicator, Window Decal, Jacket Patch. \$75.00

ZYMÖL Complete Kit - A custom designed, hinged ABS trunk carry-all with a Polyurethane dye cut foam insert for organization of Zymöl products. Wax, H-D Cleanse, Brite, Clear, Applicator, Towel, Wheel & Detail Brushes, Spray Bottle, Treat, Vinyl, & Detail Wax. \$200.00

1-800-245-2546 USA & Canada
24-hour answering machine

Specialty Car Care Products

786 Baylor Road
Rochester Hills, MI 48309-2511
Visa & MC

Cold idle fixes for 900

I have a 1985 900 Turbo with 48,000 miles. When the weather warmed up last Spring, it began the typical "die at idle until warm". This was soon followed by "die upon deceleration when approaching idle".

The solution to this problem was complicated because three separate items contributed to it. In succession I replaced the automatic icle control (AIC) valve, the throttle damper (or "dash pot", Saab P/N 9314501), and a hose clamp on the turbo bypass valve.

The AIC valve had a pitted spot in the commutator at one of the electrical contacts. The throttle damper no longer eased the last portion of the throttle travel before idle, but let the linkage slam abruptly into the idle set screw. The nylon hose clamp had broken and allowed unmetered air to enter past the bypass vlave. I had checked for vacuum leaks but didn't find anything until a helpful mechanic at the local dealer, Mallory Nissan-Saab, pointed out the broken hose clamp. I replaced this with a conventional metal hose clamp.

Unfortunately, I didn't get to the inexpensive part of the solution, the 79 cent hose clamp, until last. If you have a similar problem, by all means check the hose clamps on the bypass valve first. They're awkward to reach, so it was probably easier for the factory to install the self-locking nylon ones.

The bypass valve is clamped to the intake air tubing, right next to the turbo-charger. The valve has two hoses connected to it, one about one inch outside diameter, and the other about 1/4 inch O.D. The clamp connecting the valve to the turbo, and the one connecting the one inch hose to the valve are both nylon.

I wouldn't recommend disassembling the AIC valve as I did, because even though I found the pitted spot which probably caused the valve to stick, I couldn't crimp the valve back together tight enough to avoid a vacuum leak. This is an expensive part, about \$140. Try cleaning it (see Tim Brown's letter in April 1989 NINES), but if the idle still fluctuates, replace it.

The idle is still a little tentative when I first start the car, but it rarely dies. After the first 30 seconds, there are no more idling problems.

Richard J. Kohnen
Creve Coeur MO



SAAB CLUB SPECIALS of the MONTH

Oil Filter	93 09 576	73 on & all V4	\$5.30 ea.
		12 or more -	\$5.00 ea.
Air filter	75 14 722	900 16 valve	\$13.00
Air filter	93 81 971	9000 flat style	\$14.50
Air filter	93 90 907	9000 cylinder style	\$17.00
Front brake pads	89 93 776	99/900, 75-87	\$48.00
Front brake pads	41 07 116	900, 88-on; 9000 exc 88- T	\$73.00
Rear muffler kit	88 17 850	900 8-vlv non-turbo,	
w/tailpipe		81 - 86½	\$85.00
Plug wire set	88 17 314	900 16 valve	\$55.00
Distributor cap	75 01 216	All 4 cyl. exc Delco	\$5.50
Water pump	88 17 900	900 81-on	\$63.00

Expires June 7, 1991

WE KNOW SAAB'S

Prices subject to change
without notice.
Expires Month End.

1-800-225-2528
FAX 414-355-7831

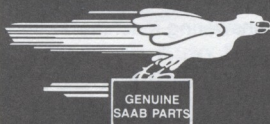

Open 8 am to 6 pm
Monday thru Friday

BOB YATES IMPORT CAR SPECIALISTS

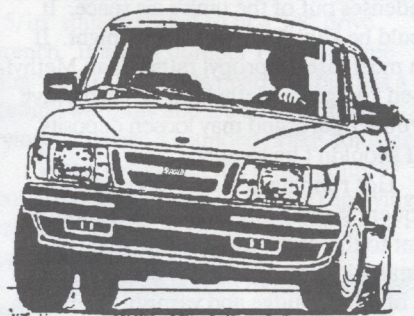

TOLL-FREE PARTS LINE
1-800-669-SAAB

Fax# 215/752-5614

Discount to SAAB Club members

Rt. 1 & I-95
Langhorne, PA 19047

1991 NATIONAL SAAB OWNERS CONVENTION

August 2nd, 3rd & 4th Seattle, Washington

The Northwest SAAB Owners Club is proud to host the 1991 National SAAB Owners Convention at the Crystal Mountain Resort, just 1 1/2 hours southeast of Seattle. This special three day event will feature a Friday night get-acquainted party, SAAB technical sessions, an informal concours, new & vintage parts swap, scenic tour of Mount Rainier, Saturday evening gala banquet with SAAB guest speakers and Sunday morning brunch with round table discussion. We are looking forward to a great weekend, and hope to see you there. For detailed information on this event, please refer to the article in this issue of NINES.

For your convenience, 200 rooms will be held at the Crystal Mountain Resort until July 1, 1991. You must reserve your rooms directly with the resort. Please contact Phyllis at (206) 663-2558 to reserve your room.

CONVENTION REGISTRATION INFORMATION:

NAME(s): _____

ADDRESS: _____

CITY/STATE: _____

ZIP/PHONE: _____

SAAB(s) OWNED: _____

INTERESTED IN INFORMAL CONCOURS (Y/N): _____

REGISTRATION FEES: (Include Friday party, 3 meals on Saturday and Sunday brunch.)

Total Number of Adults:

Whole Event _____ x \$65 = _____

Saturday Only _____ x \$50 = _____

Total Number of Children under 12:
(whole event or sat. only)

_____ x \$25 = _____

TOTAL = _____

Check or money order payable to:

Northwest SAAB Owners
C/O Skip Schott
20220 80th Ave. SE
Snohomish, WA 98290
Ph. (206) 486-1351

Cancellations for full refund will be allowed until July 5th.

SPONSORED BY:



■ PORSCHE/SAAB/LOTUS

Seattle, WA

Bel-Kirk Motors

SAAB VOLVO

Kirkland, Washington

CAMPBELL-NELSON
VOLKSWAGEN/SAAB
EDMONDS, WASHINGTON

CAMPBELL-NELSON
AUTO WRECKING
EDMONDS, WASHINGTON

BILL HAZELETT
CHEVROLET/SAAB/GEO
KENT, WASHINGTON

Don't Spoil the Soil with Used Oil

According to the Automotive Information Council (AIC), each year 240 million gallons of used motor oil are dumped into America's environment by do-it-yourself oil changers, who may not know the detriments of their actions.

Think again about what to do with that gallon of black, used motor oil sloshing around in your drain-pan if you perform your own automotive oil changes. It may not seem possible that such a small amount of use oil can be harmful. However, according to the U.S. Environmental Protection Agency (EPA), when handled improperly, one quart of oil can ruin the taste of 250,000 gallons of drinking water and that same quart can produce a film two-acres wide on the water's surface. Oil-covered water, in turn, can kill plants, animals, marine life, and cause critical damage to equipment at water treatment sites.

The U.S. Department of Energy approximates that 61 percent of do-it-yourself oil changers improperly dispose of their motor oil by pouring it in the soil,

sewers, hand-made yard pits, or by placing it in trash receptacles headed for their local landfill. Improper oil handling represents a staggering 240 million gallons of used motor oil which pollutes our soil and water supply on a yearly basis -- the equivalent in volume of five oil tankers spilling their entire loads.

Pouring used oil into storm or sanitary sewers is tantamount to pumping it directly into the water supply. The same holds true when pouring it into the soil; the oil will eventually seep into the groundwater. Placing used oil in a sealed container and putting it into the trash invariably leads to the container breaking, the used oil leaking into the soil, and ultimately into the groundwater.

So what should you do with that used motor oil? You may want to reconsider the long-term maintenance and environmental advantage of having your routine auto services performed by an authorized Saab dealer. This not only ensures that genuine Saab parts and accessories are utilized which meet your Saab's specifications, but that your used oil is handled in accordance with environmental requirements.

Besides polluting the environment, dumping used motor oil also wastes energy.

The American Petroleum Institute, or API, estimates that if all of the used motor oil generated by Americans were to be collected and burned for electricity, the resulting energy would meet the needs of 900,000 homes per year. Additionally, used oil can be recycled or re-refined to produce high quality lubricants or fuel oil substitutes. API calculates that one gallon of used motor oil can be processed into 2.5 quarts of high quality automotive oil.

If you change your own oil, Saab also recommends that you abide by the environmental and safety precautions outlined in your car's Owners Manual. Prior to changing your oil, locate a used motor oil collection center that will take your waste oil and properly dispose of it.

Saab also cautions that used motor oil is considerably more toxic than fresh oil. In fact, according to API, used motor oil contains carcinogenic and other toxic substances.

It may take a little time to find an oil collection site, but in the interest of preserving our precious environment, the effort is well worth it.

Many states employ used oil coordinators to assist consumers in locating recycling centers. Write:

Director, Used Oil Programs,
U.S. Environmental Protection
Agency, WH565A,
401 M Street S.W.,
Washington, DC 20460,
or for more information on recycling
oil and establishing a used oil recycling
program in your community, contact:
American Petroleum Institute
1220 L Street N.W.
Washington, DC 20005.

SAAB PARTS

AUTHORIZED SALES • SERVICE

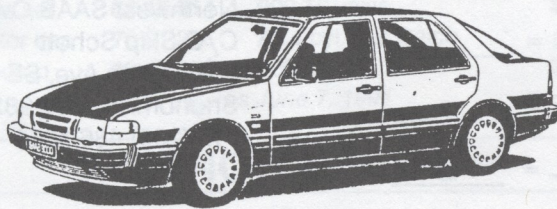

**NO SALES TAX • 10% DISCOUNT TO CLUB MEMBERS
SHIPPING ANYWHERE • KNOWLEDGEABLE PEOPLE
SAAB FACTORY TRAINED MASTER TECHNICIANS**

ALL MAJOR CREDIT CARDS ACCEPTED

Monte Shelton
MOTOR COMPANY

1638 WEST BURNSIDE • PORTLAND, OR • 503/224-3232

ROLLS ROYCE • JAGUAR • SAAB

hakkapeliitta snow tires LOWEST PRICES

185/65-15 NR09 mounted & balanced on Saab 900 or 9000 steel wheels			\$115.00
	<u>NR.09</u>	<u>Hakka. 10</u>	
155x13	\$48.00	\$50.00	
165x13	\$49.00	\$51.00	
165x15	\$53.00		
185/65x15 Rollsters			\$51.00
<i>While Supply Lasts</i>			

G & G Service
4073 Hubertus Rd 414-628-1716
Hubertus, WI 53033



BAYSIDE

■ PORSCHE/SAAB/LOTUS



**Proud Sponsor of the National SAAB Club Convention
August 2 - 4, 1991 Seattle, Washington**

9000

	Reg. Price	SALE
Aero Wheels (set) 86 -	2600.00	2100.00
Ronal R15 Wheels 86 -	250.00	200.00
Cross Spoke Wheels (set) 86 -	2316.00	1850.00
Silver Spoke Wheels 86 -	170.00	135.00
Tuning Kit 90 195HP	675.00	550.00
Tuning Kit 90 177HP	595.00	470.00
Tuning Kit 86-89 170HP	312.50	195.00
Sport Exhaust CD 89 -	364.00	310.00
Sport Exhaust 5dr 89 -	311.00	260.00
Sport Exhaust 5dr 86-88	327.00	275.00
Rear Spoiler CD 89 -	375.00	300.00
Rear Spoiler 5dr 87 -	304.50	240.00
Rear Louver 5dr 86 -	295.00	235.00
Headlites 5dr 86-89	152.50	110.00
Car Covers	170.00	135.00
Floor Mats	115.50	90.00
Wood Dash Inlay	995.00	875.00
Euro Headlite Kit 86-89	425.80	340.00
Cargo Mat 9000 4dr 89 -	92.00	70.00
Cargo Mat 9000 5dr 86 -	94.80	70.00

95-96-97

Center Grille 95/96 69 -	35.90	28.00
Rear Transmission Mount	32.90	25.00
Mudflaps 95/96	14.60	11.50
Manifold V-4 2BL	383.00	295.00
Rear Lens 95 69 -	26.90	20.50
Timing Gear Set V4	181.00	140.00
Handbrake Cable 95/96	22.25	17.50
Door Seal 95/96	42.40	32.50
Front Park Lens 69 -	30.40	24.00
Rear Lens 96	38.00	29.00
5 Blade Fan - V4	45.80	35.00
95-96 Windshield 68 -	151.50	120.00
95-96 Front Fender - 68	144.50	115.00
95-96 Front Fender 69-71	184.50	145.00
95-96 Front Fender 72 -	175.00	135.00
95-96 Front Muffler - V4	49.40	37.50
Engine Oil Dipstick V4	13.75	11.00
Sonett III Center Grille	125.00	95.00
Balance Shaft Bearings - V4	39.95	30.00
Rear Brake Shoes - Girling	29.95	22.00

900

	Reg. Price	SALE
SPG Wheels 88 -	263.50	200.00
SPG Wheels 81-87	253.00	195.00
Ronal R15 Wheels 88 -	250.00	200.00
Silver Spoke Wheels 88 -	170.00	135.00
Tuning Kit 90 - 185HP	800.00	650.00
Tuning Kit 86-89 170HP	312.50	210.00
Sport Exhaust 87 -	376.00	275.00
Chassis Kit 79 -	936.50	725.00
Rear Louver 3dr	295.00	225.00
Floor Mats	103.00	80.00
Cassette Holder	34.00	25.00
Sunroof Wind Deflector	83.20	65.00
Euro Headlite Kit 87 -	430.10	345.00
Euro Headlite Kit - 86	477.60	375.00
Cargo Mat 3dr 81 -	69.20	55.00
Hood Protection Strip	42.00	32.00
Water Pump 81 -	76.60	60.00
Air Outlet Covers	42.00	33.00
Headlites 87 -90	150.00	110.00
Rear Spoiler 3dr 79 -	197.00	145.00

99

Turbo Manifold	402.00	320.00
Water Pump	117.50	90.00
Front Grille 75-80	94.50	75.00
Head Lamp Doors 75-80	34.70	27.00
Primary Gear	201.00	150.00
Shift Coupler	55.00	42.00
Slave Cylinder - New Style	71.10	55.00
Throw Out Bearing 76 -	23.75	18.50

OSRAM BULB SALE

H-1 55 Watt	6.95	4.25
H-2 55 Watt	6.30	4.00
H-3 55 Watt	6.95	5.00
H-3 100 Watt	16.75	12.00
H-4 60/55 Watt	10.95	9.00
H-4 100/55 Watt	17.50	12.00
H-4 100/80 Watt	17.95	12.50
9004 65/45 Watt	13.60	10.00

SPECIAL ITEMS

Blaupunkt "Monterey"	365.00	110.00
Castrol 75W Gear Lube	2.80/pt.	1.75/pt.

**517 E. PIKE ST.
SEATTLE, WA 98122
(206) 328-2303 1-800-537-9635 FAX (206) 322-4562**



VISA MC AMEX



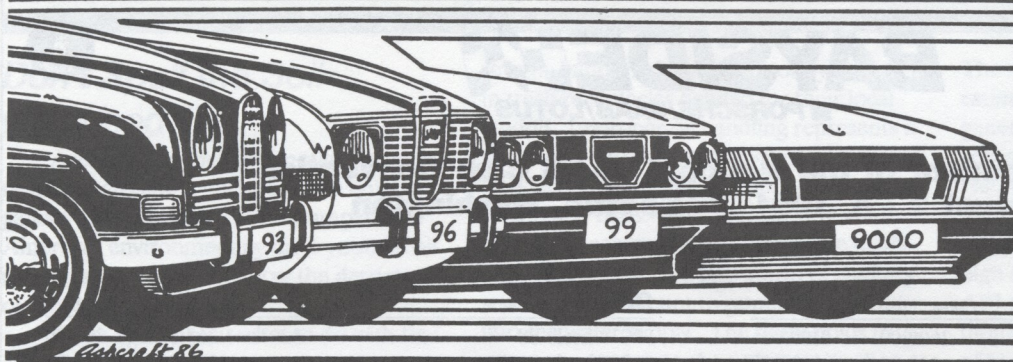

SAAB SWAP

CLASSIFIED ADS

CLASSIFIED AD RATES

Ads offering parts or SAABs for sale or wanted are available to members and non-members. Ads are limited to 25 words, plus name address and phone number. Ad copy will be abbreviated and excess words deleted where possible. Enclose sufficient funds with your ad, we do not bill. No ads will be taken by phone. The Classified Ad rate is as follows:

	Members	Non-members
CARS FOR SALE	\$10.00	\$15.00
PARTS FOR SALE	\$5.00	\$7.50
WANTED ADS.	\$2.00	\$3.00
COMMERCIAL ADS (Parts & Services)	\$10.00	\$15.00

DEADLINE: The 15th of each month for the following month's issue, e.g. January 15th for the February issue. Newsletters are mailed the first week of the cover month.

COMMERCIAL DISPLAY ADS: Contact the editor for rates and info. Deadline, the 10th of each month for the following month's issue.

Sonetts For Sale

'74 Sonett III, original owner, looking for good home. Yellow, almost new tires, good wheels, engine. Needs trans & chassis work. Extra parts. Best offer. Carl Steinecker, Milford MI. 313/684-1056.*

'74 Sonett III, Red, 2nd owner, v. gd condition. Will consider a solid offer before 5/1/91. Bob Holtan, 2617 34th Ave SW, Fargo ND 58104. 701/232-8898.*

'73 Sonett III, 85k mi, Black with black & tan interior, in covered storage 6 yrs. Nice cond in & out. \$1,200. Frank Albanese, 3921 Pier Walk, Oxnard CA 93035. 805/985-4793.*

'72 Sonett III, runs & looks great, Red, sunroof, stored winters. \$3,000 or trade for 93/95/96. Jim Grayson, PO Box 491, Pewaukee WI 53072. 414/691-9137.

'71 Sonett III, complete, restorable, \$700 obo. Also, 69 hood & doors, 3 & 4 cyl engines & many hard to find parts. Incomplete list, \$1. Dick Florich, 631 Jordan Circle, Colgate WI 53017. 414/628-0589.

'68 Sonett V4, Exc cond. 7k mi since complete restoration, solid, no rust. \$4,000 obo. Trades possible. James P. Smith, 43200 N Lewis Ave, Zion IL 60099. 708/872-8852.

'68 Sonett V4, good cond, rebuilt eng/trans & brake system. New tires, Sonett-III mags, Isky cam, Weber carb, electric fan; owner Saab mechanic. \$2,950. Rich Olin, 3400 Hanover Ave, Richmond VA 23221. 804/355-4586.

'67 Sonett II, Excellent overall condition, with effort could be concours quality. \$8,500 obo. Mike Tucker, 57 Botany Woods, Hartsville SC 29550. 803/383-5443.

93s, 95s & 96s For Sale

'73 96, BRAND NEW! Never registered. 2,500 original miles. Car is showroom new. Offers over \$10,000. Ron Raymond, RD #2, Box 62, Munnsville NY 13409. 315/495-6198.

'70 96, good condition. Retired doctor's car. Weber, sports exhaust, little rust, \$950. '73 96, running, Weber, sports exhaust, body not as good, \$450. Herbert Wheeler, PO Box 127, Keene VA 22946. 804/286-3653.

'70 96, needs trans work. Large asst of spare parts, V4s, etc. Make offer. Dale DeValerio, Detroit MI. 313/371-7963 or 521-8500.*

DuStroke's Two Stroke '67 95L, original paint, orig oil inj 3-cyl eng. Complete spec sheet & photos avail. Beautiful condition, requires excellent home. Fairly priced, will discuss delivery. Simon DuStroke, 519/767-0819.

'66 96 Spl, nice, white, \$2,696. '67 96, tan really nice, \$3,296. '67 96, kinda blue, \$1696. '67 96, ugly green, \$896. All clean, solid, standard engines. Larry Williams, 3322 Rosehill, Waterloo, IA 50701. 319/235-0275.

'63 96, runs, rough but restorable, some extra parts. \$450. Ed Whaley, 707 Arlington Ave, Chattanooga TN 37404. 615/629-7263.*

'58 93 two-stroke. Call for information. Gabriel Boenzli 35221 Riverside Dr, Albany OR 97321. 503/967-7276.

'55 92B in "bottle green" what else! S/N13392. 76k mi. Originally owned & imported by Saab mechanic. Runs great, paint & upholstery in excellent condition, new brakes & hoses. Photo available. \$7,500 obo. LaJolla Auto Sales & Leasing, PO Box 1718, LaJolla CA 92038. 619/456-0522, fax 619/454-5981.*

2-Stroke & V4 Parts

95, 96, 97 parts: \$2.00 for list. '68 Sonett & '72 95 for parts (no titles). Factory repair manuals and much more. Kay Tucker, Rt.1 Box 68, Earlysville VA 22936. 804/973-5298.

I have several crates of old misc Saab parts for various models which I am willing to trade for any old Alfa parts. Call with what you or your friends may have. Trades only. Charlie Dodson, 7 Wainwright Ave, Annapolis MD 21403. 301/267-9245.

1.7L V4 engine and accessories. New! Never been in a car. Will send photos and ship anywhere. \$1,700. Stephen Miracle, Montpelier VT. 802/223-3524.

'59 to '72 3-cyl & V4 mechanical & body parts, some new. No list, send SAE with your needs. Reasonably priced. Newly rebuilt '65 3-cyl eng, complete, new 1mm pistons & rings, bearings. \$700. Herbert Wheeler, PO Box 127, Keene VA 22946. 804/286-3653.

'70 V4 engine, complete, 30k. 4spd trans, complete instrument cluster, door assys, windshield, bumpers, new exhaust, rebuilt alternators, starter, wheels & tires. Mark Malan, Boulder CO. 1-800-248-8825 ext 547.*

99s, 900s & 9000s For Sale

'87 900T, 77k mi, leather, 1 owner, excellent. \$8,450. Ron Raymond, RD #2, Box 62, Munnsville NY 13409. 315/495-6198.

Fire Sale! 99 EMS, only 20k mi, all original parts, plus trailer kit. Bill Fox, PO Box 90, St Paul AR 72760. 501/677-2358.*

'79 900EMS 3dr, 4spd, Blue, 100k+ mi, straight with some rust, AC, AM/FM Blaupunkt, rear spoiler, soccerballs, new interior. \$1,300. Scott Bradley, PO Box 37116, Omaha NE 68137. 402/451-6840 eves.

'77 99 Turbo 2-dr, 140k mi, \$3,500 obo. Al Vinton, 312 Flora Dr, Champaign IL 61821. 219/352-5609.

'73 99LE 2-dr, rebuilt automatic trans, leather steering wheel, many new parts. Ralph Mezrow, 1220 Rock Crk Rd, Gladwyne PA 19035. 215/896-8308 or 839-3354.*

99, 900 & 9000

Parts & Accessories

4-speed gearbox with 6:31 ring & pinion. Everything is new, rebuilt by Eriksson Industries. \$1000. Dave McHugh, Pequot Motorsport, Fairfield CT. 203/255-4344.

900 Parts: 79 distributor, PS pump & taillights, \$75 for all 3. Late model vented rotors, \$60/pr. Valve shim kit for all 8-valve engines, \$50. Mike Tucker, 57 Botany Woods, Hartsville SC 29550. 803/383-5443.

99 & 900 OEM parts, wholesale prices to SAAB Club members. Aftermarket parts, engines, transmission, large assortment of used parts. New cylinder heads, 81 +; new-style heater control valve; new-style outer CV joint. Call for price and availability. Installation and service available. Mastercard and Visa accepted. Trollhattan Motors Inc., 310 George Ave, Baltimore MD 21221. 301/682-4688 or 1-800-32-TROLL. Evening and Saturday hours.

99 & 900 Headliner Kit, comes with glue, 3 1/2 yards of material and complete instructions, \$87.50. Other parts available. Trollhattan Motors Inc., 310 George Ave, Baltimore MD 21221. 301/682-4688 or 1-800-32-TROLL. Evening and Saturday hours.

Parting out: fifteen 99s and twenty-one 900s, 1973 thru 1988; one '86 9000. New OE sunroof deflectors, 9000 only, \$39.00. Quantity discounts. Rod Beckner, 604 E First St, Albany OR 97321. Tele/fax 503/928-6351.

900 & 9000 Parts: 79-90 engines, trans rebuilt & used, interiors, headliners, wheels, new & used turbos, much more. European Car Parts, 57 N Plains Industrial Rd, Wallingford CT 06492. 203/284-8989.

Used Microfiche reader, excellent condition. Compatible with Saab microfiche. 11"x 14 1/2" screen, \$75. John Ogilvy, 104 Whetstone Ct, Durham NC 27703. 919/596-4077.

4 mag wheels, 135TRx390FHx45, Saab p/n 8936262, \$100 obo. R.C. May, PO Box 1112, Newton IA 50208. 515/792-5901.

Four Pirelli P8s w/30k mi, lots of tread for spares, \$100. One OE alloy from '83 Turbo, slight bend, best offer. non-leather 5-sp shift knob, \$10. Ashtray assy, \$10. Dan Orzano, Columbus OH. 614/231-3892 after 6pm.

Parting out '86 9000. May other used parts for older Saabs. Harry Fleury, 16 Towers Rd, Essex Jct VT 05452. 802/878-5423.

Three 24-spoke alloys w/caps, \$70 ea. Two P8s w/75% tread, \$30 ea. Orig AM-FM from '67 96, \$40. +shpg. Bill Bullard, RFD 2 Box 263, Alfred ME 04002. 207/324-6371 eves.

1970-74 99 parts, incl good doors. Larry Crozier, 1316 Pinehurst Dr, Ft Wayne IN 46815. 219/424-4092 H, 219/744-4181 W, 219/744-1835 fax.

'80 900T 3dr for parts, 88k mi, hit rear. exc engine w/Turbo Saver. No trans. \$600 for all, or will separate. Jay Reiling, 72 St Albans St, St Paul MN 55104. 612/224-6313.

'76 99GL 5spd, excellent body, unknown mechanical (drug seizure car). Clear title. Send SASE for photo. \$1,200 obo. Bill Snook, PO Box 149, Orofino ID 83544.*

NINES newsletters, 1982-90. \$40 incl S&H. Ed Bruno, 277 State St, Bangor ME 04401. 207/942-3988 9am-noon.

Your SAAB manual transmissions rebuilt from \$795. Includes replacement of bearings and seals, and set to factory specs. Why buy used and not be sure? Call for details. Freight additional. Mastercard and Visa accepted. Trollhattan Motors Inc., 310 George Ave, Baltimore MD 21221. 301/682-4688 or 1-800-32-TROLL. Evening and Saturday hours.

Wanted, All Models

Late model V4. Prefer 95 wagon, will consider 96 sedan. George Theofiles, PO Box 1000, New Freedom PA 17349. 717/235-4766.*

Maroon Saab corduroy seat covers for '78 99T. Also, wood shift knob for same. Ron Raymond, RD #2, Box 62, Munnsville NY 13409. 315/495-6198.

'86 or '87 creampuff 9000T: must have 5spd & leather. Special concern for quality of maintenance and condition of interior. Gary Wahman, Edina MN. 612/928-8110.

96 trans tool, p/n 78-41-22(4) "Pinion Shaft Arbor"; to buy (\$25?) or borrow (to copy). Peter McLaughlin. 1804 Grant St, Evanston IL 60201. 708/869-0443.

Pre-67 96: grille turn signals. V4 96: valve covers for 1.7L, windshield, right rear wing, charcoal canister, old manuals. 900: between seats panel, 3 Saab-Scania emblems, 1 1/2" dia. Will trade for ft muffler, 900 steel wheels. Robert Wagner, PO Box 164, Manorville NY 11949. 212/935-3960 W.

900 voltmeter, air temp, oil temp gauges, incl all wiring, new or used. David Toti, 32 High St, New Haven CT 06510. 203/562-9005.

Saab Club newsletters from Jan 84 to Oct 87 (#121-#163). L.V. Majoch 504 Crestview Dr, Milford DE 19963. 302/422-6608 or 422-9321.

New F&S pressure plate for '66 Monte Carlo. Tom Nelson, PO Box 8025, El Rancho CO 80401. 303/526-9138.

'88 or newer SPG wheels, whale tail spoiler, SPG/OEM or recent factory aero kit. Dan Orzano, Columbus OH. 614/231-3892 after 6pm weekdays, afternoons on weekends.

Dutch collector seeks Sonett II - III in good running condition. Also Sonett II & III parts. Send photo, price. Frans Meulendyks, PO Box 53, 5710 AB, Asten HOLLAND

andrews

INC. OF PRINCETON
EXCLUSIVELY SAAB

612 / 389-3805

April SAAB Specials

Cool Summer Thermostats, 99/900 \$6.00
Cool Radiator Fan Thermostats \$5.50

Heater Valves 99 \$40.00
900 \$82.00

Trailer hitches, 900/9000 \$85 -150.00

** Time to start thinking about summer camping and fishing. These hitches will haul up to 2500 lbs., some have removable drawbar.

Mann/Saab Oil filters, V4 thru 9000 \$3.59

** Did you know that Mann makes the Saab Oil filter that costs so much at the dealer? Blue paint must be expensive! **

VISA/MASTERCARD ACCEPTED

Check us out on Used Parts, too.

All prices plus shipping

Twin Cities Metro line: 444-6868

Toll Free National Parts Line:

1-800-882-7220

(Fax#: 612-389-3875)

Route 4, Box 247

Princeton, MN 55371



TOUGH SHIFT?

In order for a transmission to shift properly, the oil must be squeezed from between the synchros and the slipperiness of the oil must be overcome so that the synchros can come to equal speeds. Oils which are too thick or too slippery will cause shifting difficulty. Modern motor oils contain additives to enhance slipperiness and improve fuel economy, which slows synchronization. In order to speed cold shiftability, SAAB recommends low viscosity lubricants such as 10W30 or 10W40 motor oils or 75W gear oils. These lubricants are generally too slippery and the shearing forces of the gear teeth reduce the viscosity of these lubricants to the viscosity of an ATF within a few thousand miles. This reduction in viscosity causes gear whine and accelerates gear wear.

Red Line MTL[®] significantly improves many of the shiftability and noise problems found in SAAB transmissions. It is an 80W (almost 85W) GL-4 gear oil which provides the same high temperature viscosity as a 10W30, but it will not lose half its viscosity like a 10W30 motor oil. The low temperature characteristics are better than an ATF and it will remain fluid down to -50°F. Red Line MTL[®] also provides gear protection of a GL-4 gear oil which is far superior to a motor oil.

MTL[®] - Manual Transaxle Lubricant

- Perfect synchro friction coefficient
- Eliminates notchy shifting
- Excellent shifting even when cold
- High-performance gear protection
- Eliminates gear whine
- Non-corrosive to synchronizers

Red Line Synthetic Oil Corporation
3450 Pacheco Blvd, Martinez, CA 94553
(800) 624-7958

Call or write for technical literature

The Vintage SAAB Racing Group tests Saab's 006 rear engine, rear drive roadster

Rotate 900 one hundred and eighty degrees and you have 006, the numerical designation of SAAB's little publicized rear engine, rear drive, roadster. The only listing we could find was on page 29 of the 1986 SAAB 900 accessories catalog, although there may have been an article in *SOUNDINGS*. April Fool, there was a 006, but it is characterized as for "off road use" and the number produced is unknown... except perhaps to Len Lonnegren and Steve Rossi.

The "off road use" does fit precisely the needs of the Vintage SAAB Racing Group. If you have ever been to a Vintage Race, or for that matter any race, you will have noticed the various forms of transportation used by the teams in the paddock and pits. In vintage circles, the different, odd, or exotic vehicles predominate. The 006, manufactured in Finland, fits right in with our objectives, drawing attention to vintage SAABs.

Settling in behind the wheel of the 006, one is at once aware of the roadster's unlimited head room, however, the 19 inches from the front pedals to the seat front, total of 31 and 1/2 inches to the seat back, places the knees beside the steering wheel. This is only a slight inconvenience until you learn that the left foot is for the brake and the right foot the accelerator. The lack of room, big adult feet, and the steering column prevent any heel and toe action.

The electric start Honda air cooled engine fires with only a bit of choke, settles quickly to proper temperature, and we are ready for a paddock lap. At first the centrifugal clutch feels a little grabby, but a little pressure on the brake keeps things under control. The one (left rear) wheel drive will put down a little rubber if you are not careful and on grass or gravel will spin like a dragster on the warm up pad. As can be expected with a springless solid axle vehicle, the ride is a bit harsh except on the smoothest of surfaces, but body lean is nonexistent. In fact, the frame is so rigid that any wheel will just pass over a pothole while the other three remain in contact with the road. The lack of weight on the front wheels does create considerable understeer which must be considered when entering any high speed corners. The single disk brake appears adequate as long as the left rear wheel is in contact with the road; care

must be taken when stopping on uneven surfaces. Maneuverability is excellent because of the visibility of all four corners of the vehicle. However, advance planning is necessary when parking due to the lack of a reverse gear; only a minor inconvenience. Unfortunately with the engine in the rear there is no trunk space, but the passenger area provides room for VSRG's occasional need to transport gas cans, air tanks, tool boxes, and coolers.

As tested, the 006 will satisfactorily meet the VSRG needs. Oh yes, the top speed (estimated) might be about 20 mph, depending on driver weight. The first appearance of our Pit Crew Vehicle should be at the next Walter Middy Challenge at Road Atlanta. Entry of the 006 Stealth SAAB in the pit race is anticipated.

Tom Cox
Woodstock, MD



SPECIFICATIONS

Curb Weight (est)	160 lbs.
Wheel base	47 5/8 in.
Track f/r	36 in.
Length	85 in.
Width	40 in.
Height	29 in.
Fuel Capacity (est)	2 gal.

ENGINE & DRIVETRAIN

Engine	Honda GX 140, OHV electric start
Horsepower	5
Transmission	Cent. clutch/chain

CHASSIS & BODY

Layout	Rear engine/rear drive
Brake System	Disk/left rear wheel
Wheels	6 inch steel
Tires	Trellborg 539-13X5.00-6
Steering	Arm and lever
Chassis	Tube Construction
Body	2 pass./fiberglass
Driver Leg Room	31 1/2 in.
Passenger Leg room	40 1/2 in.
Combined Hip Room	33 in.

MEMBERSHIP/SUBSCRIPTION

(Use also for Change of Address)

NAME _____

ADDRESS _____

CITY/STATE/ZIP _____

HOME PHONE _____ WORK PHONE _____

SAABS CURRENTLY OWNED _____

(i.e. '84 900 S 4dr. automatic / '78 99 GLE 5dr. 4-spd / '72 Sonett III / '68 96-V4 Deluxe)

Address change only - old Zip Code _____

Annual Membership fees for the SAAB Club of North America/NINES are as follows:

First Year \$29.00
 Renewal \$25.00

Canadian add \$4.00U.S.
 International add \$8.00U.S.

Please check appropriate box(es)

(Canadian and International -- Money order or check payable on a U.S. bank only. Cash OK.)

First year members receive two recent back issues of NINES and two SAAB Club stickers.

MAKE CHECKS PAYABLE TO "THE SAAB CLUB"

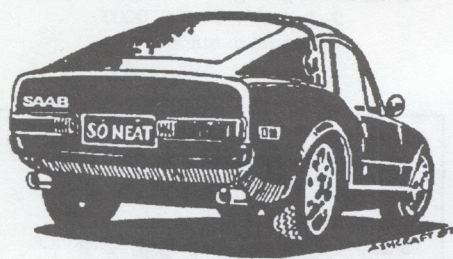

Rear View

One of the problems (and in some respects, attributes) of publishing this newsletter is its small size and one-man operation. Unfortunately, the Feb/March issue was delayed by several factors (Murphy's Law) not the least of which was a failure of the computer that holds the mailing list. Though I was able to extract virtually all of the names after a few days of trying, the only real cure is replacement of the computer.

As mentioned a few months ago, a new computer is in the works. It had already been ordered, and as of this writing (April 12) it should be on-line any day. With any kind of luck the mailing list should be transferred with little trouble. Without luck, this issue will have reached your mailbox sometime in May.

Concern for the earth has become important again over the past year (what happened to that same concern twenty years ago?) and the automobile is a significant factor in that issue. Air pollution is common in many of the major cities of the world. Now scientists tell us that the hole in the ozone layer is deteriorating more rapidly than earlier thought. Non-renewable resources such as petroleum and iron are being consumed at ever increasing rates to

keep up with demand for new products.

The best solution would be immediate elimination of internal combustion engines, but we know that won't happen. The U.S. Senate is again looking at a bill to raise the Corporate Average Fuel Economy (CAFE) of 40 mpg, a figure that current technology is unable to reach without considerable dropping of weight and size.

Working against improved fuel economy are new safety standards proposed by the NHTSA which will likely raise the weight of current cars. Can we have both safety and economy?

While Saab does an admirable job in both areas - better than most auto manufacturers - they know it will be necessary to compromise one or the other to reach the proposed laws.

A better idea than legislated fuel economy is an increase in gas taxes, and not just a few cents but a big jump. Cheap petroleum is the biggest deterrent to eliminating pollution problems. A \$1.00 a gallon tax on all gasoline would not be a burden for the vast majority of the population, including the poor. If you have a car that gets 25 miles per gallon and you drive the average of 12,000 miles in a year, the extra tax adds up to \$480 annually, less than \$10 a week. The vast majority of Americans waste that much and more on luxuries such as alcohol, cigareets, gambling, and frivolous plastic junk from "the mall".

The perception of higher priced fuel will send new car buyers scrambling for the more fuel efficient models. V8s will become scarce, V6s will be shunned, and turbo-4s will again be the performance models. CAFE will automatically rise due to the greater number of economy cars sold.

With ever increasing new truck sales (35% of the market in 1990), why all the governmental foot dragging over what is a

car and what is a truck when it comes to emissions? Anything that has an internal combustion engine and can be licensed should be labeled "motor vehicle" and regulated under the same laws. That includes motorcycles, snowmobiles, ATVs, and motorboats.

A few years ago I raised the ire of some V4 owners when I suggested that it was foolish to spend lots of time and money in maintaining an older, unreliable car for daily use. There are plenty of exceptions within the SAAB Club -- well maintained cars that get attention before there is a problem. My complaint is about those unsafe machines (and not just Saabs) that need considerable rust or collision repair, engine or exhaust work, suspension or brakes, yet are still driven daily. I strongly support any legislation that will remove those toads from the highways.

On the other hand, I will always admire an older car that is kept in good, clean running condition, even if it is regularly subjected to the rigors of traffic. Very few of these rare autos see 10,000 miles a year, so the lack of pollution controls doesn't add much to the overall problem.

Another significant problem is waste oil. Manufacturers suggest oil change intervals of 7,500 miles, mechanics say anywhere from 2,000 to 3,000 miles. The more often you change oil, the more waste oil you produce. And what becomes of the oil drained from the crankcase or gearbox? Unfortunately, many do-it-yourselfers dump it behind the garage or put it in the trash where it can pollute the groundwater. (See article in this issue.)

Of course, the ultimate solution lies with each of us. We must pay attention to our use of consumables, and recycle everything we can.

Tim Winker, Editor

NINES

The SAAB Club Newsletter
2416 London Road, Unit 900
Duluth, MN 55812-2221

Forwarding and
Address Correction Requested

April 1991

FIRST CLASS MAIL

FIRST CLASS

U.S. POSTAGE

PAID

PERMIT NO. 1909
DULUTH, MINN.

Swedish Motors, Inc.

Essex & Decatur Streets
Marietta, PA 17547
717 - 426-2202



COMPUTERIZED INVENTORY OF
NEW & USED SAAB & VOLVO PARTS

Best Prices on used engines, body,
trans, interiors, glass & more

Oldest Nokia Tyre Dealer in U.S.

VISA/MC Accepted - UPS Shipping Daily

SAAB ACCESSORIES

SONY STEREO, XR-5500 \$229.00
AM/FM/Cassette, slide out chassis

KONI GAS SHOCKS, complete set of 4
99 \$260.00
900 \$240.00
9000 \$380.00

QUARTZ BULBS
H4 55/100W \$10.00
H1, H2, H3 100W \$5.00
9004 composite bulb \$9.00

FREE CATALOG AVAILABLE

(404) 587-1356

VISA 8351 Roswell Rd, Suite 140
Atlanta, GA 30350 MC

ROADSPORT

Next Month's NINES: Transmissions

Write about your gearbox experiences -
- 2-stroke/V4, 99/900, 9000 -
manual or automatic.

NICHOLAS PELLEGRINO

FOREIGN MOTOR REPAIR

SALES **SAAB** SERVICE

282 ENFIELD MAIN RD. ITHACA, NY 14850
607/272-8259



GOLDWING USED SAAB PARTS WAREHOUSE

Nationwide Shipping UPS - COD

Alternators
Starters
Axles
Calipers
Antennas
Radios
Wheels
Tires
Tail Lights
Window Motors
Rack-n-Pinions

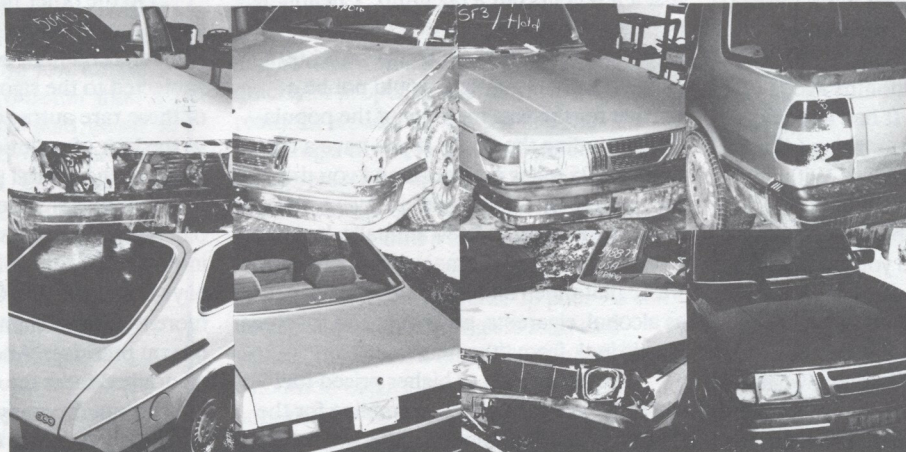

Transmissions
Engines
Radiators
Grills
Fenders
Turbos
Bumpers
Air Compressors
Cyl. Hds.
Seats

All parts Tested and Guaranteed, some Lifetime!

Over 75,000 Used Parts In Stock

We Specialize in 900 and 9000 Only

Call 1-800-SAAB137 or (315) 625-7969

Rt. 11 Hastings NY 13076