

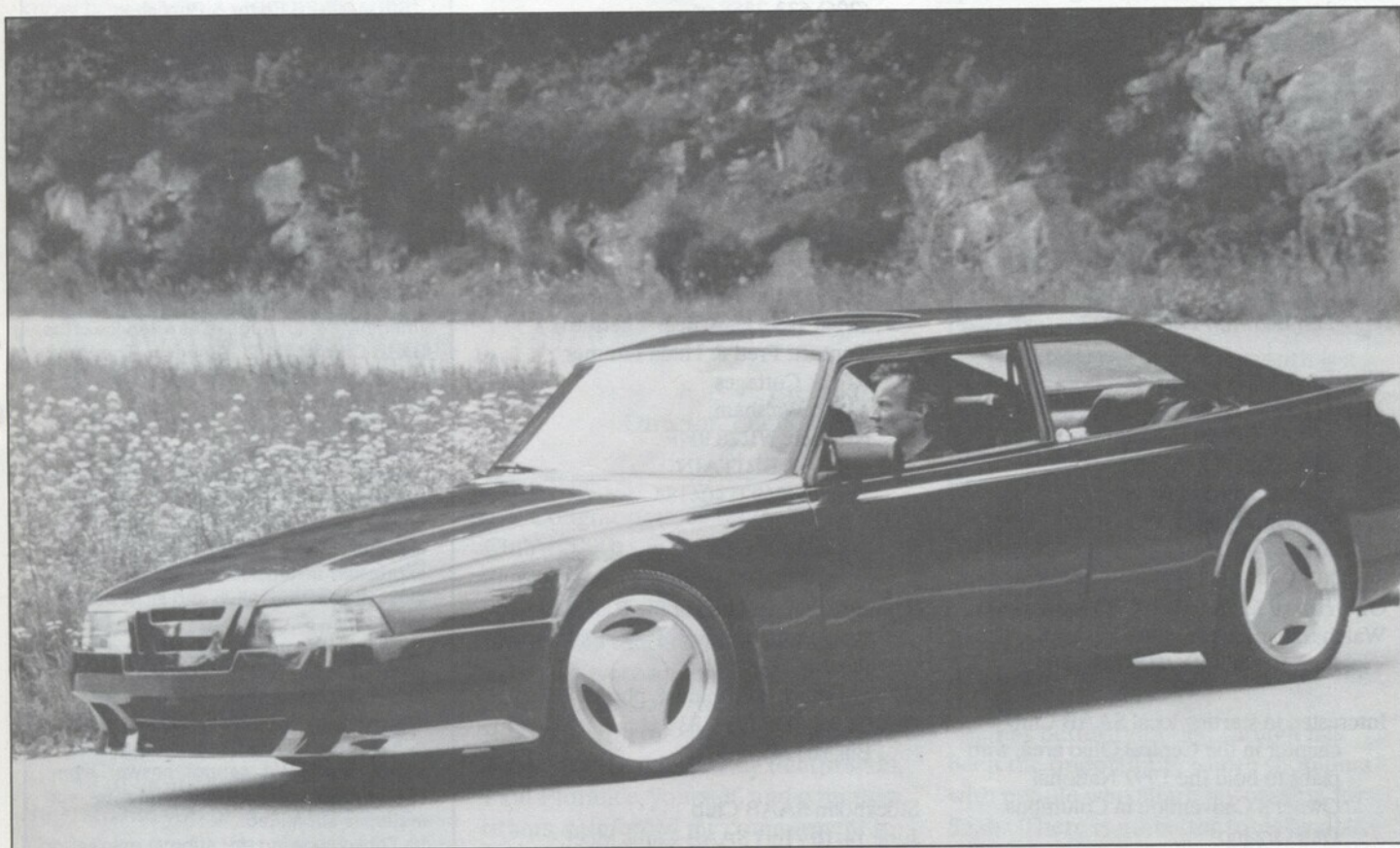

# NINES

THE SAAB CLUB NEWSLETTER

\$4.95  
February/March  
1991  
no. 200/201



Lasse Karlsson at the wheel of his LACAR. See page 33.

<b>Futuristic 900 - the LACAR</b> .....	page 33
<b>Two New Saab Ragtops</b> .....	page 10
<b>Erik Carlsson - SAAB's Rally Ace</b> .....	page 30
<b>SAAB Club History</b> .....	page 19
<b>Tech: Sonett chassis rebuilding</b> .....	page 22
<b>Turbo care &amp; feeding</b> .....	page 25

A technical description of Saab's Traction Control System  
page 13  
Comfy seating  
page 17

# Regional Club News

**Chicago (NW Illinois) SAAB Club**  
20th Anniversary Get Together. All founders & old members -- let's reminisce. Contact Andy Federowski, 312/631-4476 H, 708/498-8307 W.

**SAAB Club National Capital Area**  
March 10 - 30th Anniversary Bash. Dinner, door prizes, etc.  
Joe Apple, 703/860-1254.

**Minnesota SAAB Club**  
March 17 - Ides of March Rally. Starts at Knox in Brooklyn Park, 11:30am.  
Linda Coleman, 612/724-4752.

**Central Penn SAAB Club**  
April 7 - Week Before Income Tax Rally  
1:00, New Cumberland Boro Park  
Tim Brown, 717/627-7222

**New England Sonett Club**  
May 11 - Picnic, Patapsco Valley State Park.  
All Saab owners welcome!  
Tom Cox  
3609 Hernwood Road  
Woodstock, MD 21163  
301/465-6691

**Ohio SAAB Club**  
Watch this space for coming events.  
Pete Rechnitzer, 216/243-1488.

Interested in starting local SAAB Club chapter in the Central Ohio area, with plans to hold the 1992 National Owner's Convention in Columbus.  
Dan Orzano  
2434 Dover Road  
Columbus, OH 43209  
614/231-3892 evenings or weekends.

**Northwest SAAB Owners**  
August 2-4 - SAAB Owner's National Convention, Seattle, Washington.

For room reservations or information contact Phyllis at:  
Crystal Mountain Resort  
P.O. Box 1  
Crystal Mountain, WA 98022  
(206) 633-2558 or  
1-800-852-1444 (Wash. only).

Potential exhibitors should contact:  
Skip Schott  
20220 - 80th SE  
Snohomish, WA 98290  
(206) 486-1351.

**International Club Meets**  
**SAABFOLK Caravan/Camping Weekend**  
May 24-27 Puddleduck Farm Caravan Site,  
Great Hockham, near Thetford.  
Contact: Fred & Hilda Limmer  
6 Park Cottages  
North Walsham  
Norwich, NR28 9HF  
GREAT BRITAIN  
Phone: (0692) 404183

**SAAB Owners Club of Great Britain**  
July 26-29 - National Rally. Caravan and camping weekend at the Rally Field of Blair Castle Caravan Park, Blair Atholl, Perthshire, Scotland.  
For more information, phone:  
Colin, (0382) 541836  
Bill, (0324) 812888

**Stockholm SAAB Club**  
June 14-16 - Int'l SAAB Clubs Meet.  
Visit parts distribution center in Nykoping, engine factory in Sodertalje, world's largest SAAB dealer, and WASA museum. Sightseeing in Stockholm. Accommodations at Prize Hotel in World Trade Center.

Reservations payment deadline - 3/31  
Ragnar Johansson,  
phone: 08/6525280.

Hotel reservations:  
Prize Hotel  
Phone: +46 8 14 94 50  
Telefax: +46 8 14 98 50

## NINES

The SAAB Club Newsletter  
**February/March 1991**  
Issue #200/#201

SAAB Club of North America  
2416 London Road, Unit 900  
Duluth, MN 55812-2221

218/ 724-1336, 9am - 6pm Mon - Sat  
Fax number: 218/ 728-6307  
Head fax messages: ATTN SAAB CLUB  
(it's not our fax machine)

NINES Editor & Publisher:  
*Tim Winker*

Editorial Assistant / Clubs Editor  
*Joan Oswald*

Membership / Business Manager  
*Marketta Mannoja*

Commercial Advertising  
*Bill Taylor, 218/726-1245*

NINES is published eleven times a year (monthly except August) as a service of the SAAB Club of North America. The SAAB Club is not affiliated with Saab Cars USA, Inc. or Saab Automobile AB.

All material copyright 1991, SAAB Club of North America, or by the author. Unless copyrighted by the author, material may be reproduced with proper credit to the author and to "NINES, the SAAB Club Newsletter". The opinions and views expressed in articles are not necessarily those of the SAAB Club and its newsletter, NINES.

Editorial contributions are welcome. All material submitted is assumed to be for publication unless clearly labeled otherwise. Double-spaced typewritten articles are preferred, but most anything is acceptable. We cannot answer every inquiry and reserve the right to edit materials submitted.

Those wishing to submit articles or letters on 5¼" or 3½" IBM-formatted disks, please convert to ASCII text files (<filename>.TXT). Please include a printed hard copy, and a SASE if you want the disk returned.

**CHANGE OF ADDRESS:** Eight weeks notice is required for change of address. Please send new address and old address, including zip codes, to the SAAB Club at the address above.

**RETURNED CHECKS:** There will be a fee of \$10.00 charged for checks returned for any reason.

**NICHOLAS PELLEGRINO**  
FOREIGN MOTOR REPAIR

SALES **SAAB** SERVICE

282 ENFIELD MAIN RD. ITHACA, NY 14850  
607/272-8259

## Letters to NINES

Dear Tim:

If I have my facts straight, February of 1991 marks the 20th Anniversary of what has now grown into The Saab Club of North America, and the 200th edition of the Club newsletter.

I hope you and the Club members know how much I value my personal relationship with you and very many Saab enthusiasts around the country, and how much I look forward to our meetings from time to time - at the annual Club Convention or wherever our paths happen to cross.

Congratulations to you, and congratulations to the Club on passing this significant milestone.

Warm regards,  
Bob Sinclair  
Chairman and CEO

Dear Tim,

After attending the National Saab Club Convention this past summer, the great enthusiasm within the Saab Club and behind its newsletter became quite obvious. I was pleasantly surprised to learn that the Club's existence had spanned 20 years and that its activities have been recorded in 200 newsletters.

All of us at Saab Cars USA, Inc. congratulate you on a job well done. There is no doubt that a great part of today's Saab appeal in North America is the result of your continued interest, enthusiasm, and dedication.

I look forward to being associated with the Club, the Saab owner family, and Nines newsletter for many years to come!

Best regards,  
Sten Helling  
President and Chief Operating Officer

Dear Tim:

Twenty years? Two hundred issues? I didn't think you were that old (ha, ha). Seriously, you and your predecessors deserve hearty congratulations for not only maintaining, but cultivating, what has grown into the Saab Club of North America and the NINES newsletter.

Some of my greatest Saab memories are the result of my own involvement with the club, and I assure you, the good times will continue as we enter into the decade of the Nineties.

On behalf of all of us at Saab Cars USA, Inc., congratulations again. We look forward to working with you to further the enjoyment that the Saab experience offers in America.

Now, about Mrs. Rossi, as a 900 Turbo pilot she was reading your December issue and ...

All the best for your next 200 issues!

Steven Rossi  
Director, Public Relations

Dear Tim:

Congratulations on the Saab Club's 200th newsletter and 20 years of Saab support. From the first meeting I attended in 1974 with Dick Grossman, it was clear that the Saab Club and its members were an important part of Saab's success. My association over the years with members like Margrit Adler, Bill Jenkins, Andy Fedorowski, Paul Florance, yourself, and countless others, reinforced my commitment to both Saab and the Saab Club.

I am pleased to have been a contributor in the first few conventions and many local club functions. You can be assured that, as you head into your next 200 issues and 20 years, my support goes with you. Keep up the good work!

Yours truly,  
Arsey Miller  
Sales training/product display manager

Dear Tim:

Congratulations to you and the growing number of Club members as you reach this important milestone.

Twenty years of dedication to the distinctive Saab marque -- poured into the exacting hours and inspired words of 200 newsletter editions -- is quite significant in "my book."

I look forward to working with you in the future as we all continue to spread the good word about Saab. However, I am well aware of the personal part you have played, Tim, as a result of your interest in Saab's betterment. Thanks for the extra PR.

Sincerely,  
Karin A. Nobile  
Manager, Media information  
and publications

Dear Tim:

I understand that this month is a significant milestone for NINES and the Saab Club; twenty years of service to Saab owners across the country. Congratulations!

Over those years the newsletter has been a source of information, entertainment and occasional amusement to me. (Where else would you find out how to make a two stroke front muffler entirely out of plumbing fittings?)

Far better than that though has been the opportunity to rub shoulders with people who share my passion for Saab. There is no better tonic available whenever the automobile business starts to get a bit tedious than to go to a convention or club meeting and soak in the atmosphere created by roomful of people so magnificently out of step with "reality" as to think nothing of driving halfway across a continent in a 850cc car to be kindred souls.

Blessings on you all!

John Moss  
Saab technical manager

## From the mail bag

Enclosed is my renewal for two years -- still well worth it.

My Saab saga began in 1973 with a new 99LE automatic from a dealer who promptly discontinued the dealership! So over the years we've relied heavily on the Saab newsletter and an occasional friendly mechanic. Early on Ted Tucker was a big help; now we have a good one-man shop locally, and Rick Parr (at Parrformance) in Pennsylvania is very good for parts and advice. That '73 is resting now with 130,000 on it.

Our family has a total of *nine* Saabs -- some parts cars, others projects awaiting time.

Our '83 900S has been a joy to own. Now at 125,000 just recovering from surgery (timing chain, valves). We have averaged 27.5 mpg for the last 45,000 miles. We're looking forward to the next 100,000.

Thanks for your interesting newsletter. I realize that as the years roll on it becomes more difficult to span the time periods for all Saab lovers. Eight of our Saabs are from the '70s so I spend a lot of time with indexes of the back issues.

Elroy W. Kauffman  
Harrisonburg VA

## Ugly alloys

Here in Maine you are a terrific help. Saabs are everywhere. I bought mine due to 1) front-wheel drive, 2) two-door hatch-back with fold-down rear seat, 3) Saab's reputation for quality and performance.

I do have a question: My 1987 900S has the eight-spoke Silvervane Saab wheels. The problem is that the outer lacquer protective coating is peeling off. In many spots where the lacquer has peeled, the silver specs underneath have peeled also, leaving the flat black undercoat.

I was told that the remaining lacquer and silver could be removed with a "glass bead" treatment, and the wheels repainted at a cost of \$350. I was also told that using a paint remover would be harmful to the aluminum alloy in the wheels. I would find the all-black look acceptable, resembling Porsche wheels.

Please provide some alternatives. I

realize the problem is purely cosmetic, but I would like a solution.

John Fehlau  
Cumberland ME

*The problem you describe is common in the snow belt. I don't know if it's because of temperature extremes that crack the clear coating, or if the chemicals used to melt snow create the problem. No matter, it turns nice wheels ugly.*

*I have had several sets of wheels painted, including some badly pitted EMS wheels which now carry my winter tires.*

*The solution is glass-beading or sand-blasting and repainting. Scott Struck at Andrews body shop in Princeton, Minnesota, says that in order to get the paint to adhere, you will need to etch the aluminium with a paint prep, followed by one or two coats of a good primer/sealer such as Ditzler DP-40. If there are still some pits that need filling, add up to four coats of Ditzler K-36 or K-200, and let dry overnight. Wet sand with 320 or*

*400 grit sandpaper, then paint with virtually any paint. A two-part polyurethane paint will hold up better against chipping by road grit. Don't use lacquer as it is more susceptible to cracking.*

*These paints are not cheap, and there is a fair amount of time involved, which would explain the quote of nearly \$100 a wheel. You may be able to save some money by renting a bead blaster and removing the old paint yourself.*

*The above procedure will not work if you want to preserve the polished aluminum look. There are firms that remove the pits by grinding or polishing the aluminum wheels on a special machine. Ye Olde Wheel Shoppe in Glen Burnie, Maryland is one. They advertise in the back of AutoWeek.*

*The best solution is to remove alloy wheels in the winter. Have a set of four winter tires mounted on steel wheels and store the alloys, with your summer tires mounted, someplace dry. - TW*

## Ragbag of Rumours

Maybe it's the incredible pace of events over the past year that has caused the rumour mill to continue to produce such huge quantities of information. Some of the following you could assign to the 'likely' and others into the 'incredible' pile, but here are the current crop of rumours:

The Factory has let it slip that they are working on an upmarket model to fill out the auto giant's model range. The 95/96 will continue as the classic exotics they are, the 9500/9600 will be the mainstream models and the Sonneett will appeal to the sporty buyers. This new model will be powered by a U6 engine as described last month and will likely have all the luxury trappings one would expect of a car in the super luxury class. Double overhead fanshafts perhaps? Six turbos? The spine tingles with excitement. The prototype pictures, while very grainy, show a car of extraordinary size and of unquestionable beauty and appeal. The Source says that the design is not yet finished. But the facts are plain, it's in the works!!!

The speculation is that the Sonneett's replacement might be already in the planning stages as there is a chassis built employing the new U6 engine in a mid-engine configuration! Is this really a road car or does it mean The Factory is planning to return to big time rally work? It most certainly would be competitive with 1.5 litres displacement and nearly 200 horsepower. The competition would just give up and go home!

It seems even more manufacturers are looking at going back to two-stroke engines. As you know, for a very long time the proponents of four-stroke engines maintained that they were right sticking to such a silly idea. The Factory's takeover of the auto giant seems to have been the breach in the dam and now enquiries are flooding in. It's nice to know that truth and righteousness win out in the end.

Until next time, best wishes,

*Simon Du Stroke*

# Doktor Nio's SAAB Klinik

Submit your questions with as complete information on the problem as possible, also giving the year and model of SAAB. Problems of general interest will be answered here. No requests for personal replies please. Questions which would require modification of, or would defeat Federally required emissions systems will not be answered. For a proper diagnosis, it is recommended that you contact an authorized SAAB dealer or repair shop.

Send your questions to: SAAB KLINIK, 2416 London Road, Unit 900, Duluth, MN 55812-2221

I have a 1985 900T with about 126,000 miles on it (original turbo). As it is getting up there in miles, I have several age and wear related questions:

- 1) I recently replaced the thermostat and noticed what appears to be a salt build-up in the water channels. What is a good way to flush the cooling system (I use Prestone anti-freeze and change it every 30,000 miles).
- 2) When do the wheel bearings wear out (front and rear)? Is the special tool for changing wheel bearings required?
- 3) What is usual C.V. joint life? I try to have them re-greased every 30,000 miles. Is complete disassembly required or can I do this without pulling the wheelbearing/hub assembly?
- 4) The insulation on some of my engine wiring is decomposing. Is this normal?
- 5) What is the maximum recommended oil temperature in the engine sump? Mine gets to 210°F in the city during the summer. I use 10W-40 Castrol and change it every 2,000 miles.
- 6) My water temp gauge jumps when the cooling fans turn on or off. Is this normal? It has been doing this since I bought it (at 42,000 miles). How hot is the red zone on the gauge?
- 7) How long should the engine timing chain and the gearbox primary drive chain last? I can hear just a faint rattle at about 2,750 rpm that may be a chain. Can I replace/repair either with the engine in the car?
- 8) Should the fuel injectors be removed and cleaned or is a commercial fuel additive acceptable?

Jeff Haught  
New Orleans LA

- 1) *What you probably are noticing is phosphate build up, which is normal. I see no reason not to use a commercial flushing agent and its neutralizer the next time you drain the system.*
- 2) *Front wheel bearings are pretty husky and last 80,000 to 100,000 miles. They are sealed for life and maintenance free. There is no sudden failure. Usually a very small fault or pit will cause such*

*loud rumbling that you will have replaced it long before it would fail.*

*The rears on yours and later 900s are the same basic design as the front bearings, non-serviceable, but are part of a complete hub. These are more expensive than the fronts. Early 900s (and all 99s) have conventional taper roller bearings that can be cleaned and repacked with new grease and new seals periodically. In either case, the noise made by a wheel bearing on its way out is so obvious, it would be replaced long before failure would occur.*

3) *If you have been replenishing the C.V. joints with fresh grease that often, you should not see any problems as long as the integrity of the boots is maintained. If a worn joint requires replacement, the axle can be removed while allowing the hub or spindle to stay in place. The ball joints must first be unbolted, then the shaft can be slid out of the hub by itself.*

4) *Yours is not the first inquiry into the deterioration of 16-valve engine wiring harness insulation. I'm going to venture to say that it is normal. I have seen and heard of this occurring from all parts of the country. My only explanation is that the supplier to Saab may have been the same one that sells headliner material to the factory.*

5) *It would be rare for you to see the oil temp exceed 350°F (175°C). This kind of temperature is only realized if the turbo has been run at extremely high speeds for a sustained period and then stopped and idled. This is when hot oil from the engine is no longer cooled by air flow through the oil cooler and thus the temperature rises. 210°F (100°C) is not even stressing the oil yet.*

6) *The temperature gauge jumps because of a grounding bleed-back that can be remedied by cleaning all terminals at the grounding point on the frame just under the right cooling fan. I think the red area on the gauge is around 240°F. This does not mean there isn't a spot in the cylinder head that is higher than that. At that point there could be steam above*

*one or more combustion chambers planning to crack the head.*

- 7) *The timing chains in the 16-valve engines make most of their noises at idle. There is an improved tensioner available to take up the slack. If the chain or guides are at fault, they can be exchanged without removing the powerplant.*
- 8) *There are air pressure assisted fuel injector flushing systems used in many shops that will purge the entire system of carbon and other particles that build up in and on the injectors. Find a Saab or Bosch shop with this equipment. Most of the commercial additives will only help slow the build up of deposits.*

I have a 1983 900 Turbo with the Sony XR-75 radio. I am having noise and poor reception problems. The initial noise suppressors got broken and have been replaced with those specified in the factory manual. These do not seem to be as effective as the package used on the original installation. I have a problem with the ground tab on the back of the radio also; this seems to work loose and then the alternator and ignition noise comes in no matter what suppression is on the engine.

I also have very poor reception. This seems worse since I replaced the original antenna, after it broke, with the factory replacement.

I am enclosing three dollars for the ten-page service bulletin on the XR-75 (S.I. 12/82-605 & 11/82-597, also covers XR-70).

Virgil Gerdes  
Irvine CA

*Follow the advice in the Service Information. It will involve a lot of cutting and rerunning of wires. You may want to replace the RCA cables from the head to the amps to clean up the sound quality. The antenna coax cable may be at fault as far as reception is concerned. If you are handy with a soldering gun, solder new plugs on the ends first. The new connectors usually clear up reception problems.*

Continued next page

I have a 1986 900S 16V 5-speed with 73,000 miles. My problem is that when decelerating in second or third gear, when the revs drop to about 2200 rpm, the car begins to lunge or surge and continues to do so down to about 1500 rpm. Below this point it smooths out again. If I lightly apply the accelerator to maintain speed or gradually speed up while in the "warp zone", I get a moderate jerk followed by the same mild lunges experienced during deceleration until the 2200 mark is met.

Interestingly, when working up through the gears more briskly from below the lower limit, or more aggressively pushing the go pedal from within the range, the problem is non-evident. Occasionally, this brisk acceleration will yield a very subliminal miss (detonation).

A few further observations which may or may not be relevant: the up-shift light lights briefly every time I start the car and about once a week otherwise; at times it even lights in fifth (was there a six-speed option I missed?) Cold start on a warm day resulted in hunting at idle before the onset of winter. I think the clutch feels soft and what I can see of the lining through the inspection cover looks thin compared to the illustration in my Haynes manual, but the dealer says its okay.

Doug Mundy  
Hurricane WV

*Due to the observation you made concerning the up-shift lamp, I would begin by cleaning and securing the grounds at the radiator crossmember below the right cooling fan. It may just be coincidental, but check this and all other grounding points on the engine.*

*There is a voltage step-up from the control unit to the injectors between 2500 and 3000 rpms. Have a qualified shop check voltage and resistance readings against factory specs for all the sensors and circuits. Don't rule out an ignition timing control problem with the "EZK" ignition system. Some system malfunctions are not reported by the "check engine" lamp. Try swapping control units from a properly operating donor.*

*Recently we experienced a 16V car that exhibited many driveability problems that did not relate to a system fault. As it turned out, the vacuum booster for the power brakes was leaking vacuum and throwing the system off. One other had a defective fuel pressure regulator that was not adjusting fuel pressure between full load and vacuum.*

*As for your soft clutch, as the disc wears down, the pedal effort increases. Sounds more like leaking hydraulics at the master or slave cylinders.*

The brake lights in my '87 900S (53k miles) stay lit for about 10 seconds after I exit the vehicle. Could this be a new safety feature? Won't Volvo owners be jealous? Doubtful. I can cause the lamps to extinguish sooner if I move the brake pedal up with my foot (about 1/2 inch) at which time I hear the sound of rubber bending. The brake pedal does eventually return to the top of the stroke on its own - but not very quickly, and yes the brakes are dragging slightly, but only before the pedal is lifted. The parking brake lever has about 6/7 clicks of free travel before it engages. With the engine off, this problem is lessened.

Pressing down very hard on the brake pedal seems to cause the lamps to extinguish a little sooner because the pedal retracts faster. Sometimes I hear a low hissing noise from somewhere in the dashboard, which ceases immediately upon movement of the brake pedal. What do you suggest? If this is a vacuum unit, would my extended warranty cover it?

John P. Wrycza  
Naperville IL

*Since the problem is lessened when the engine is off, suspect the power booster. We have had several 9000s with this problem and the booster was at fault, so don't rule it out in your 900. Also, be sure to check the cruise control cut off switches which may be adjusted too tightly against the pedal.*

*As for your extended warranty covering the booster, you'd better read the contract for items covered. It may depend on what policy you purchased.*

I am interested in adding some of the newer 9000 Turbo features to my 1988 9000 Turbo, such as headlight washers, power driver's seat, airbag, 20+ more HP, etc. What are your suggestions for these items? I am willing to pursue used parts to save money.

Mark Komanecky  
Holmdel NJ

Can I put headlight wipers on my 1990 9000 Turbo five door? Is there a kit available? Any idea how much it might cost? Also, what is your opinion for European headlights? My car seems a little under lit!

Raymond Oram

*Whew! Anything is possible providing*

*you are willing to spend the money. The two simplest and cheapest changes you could make would be an APC performance control unit (as mentioned in my column of January, '91) and a power seat from a salvaged 9000.*

*The U.S. version of the 9000 with headlamp washers and wipers has DOT approved headlamps that fit the "slant nose" that formerly set the CD apart from the standard model. In order to use the later system, a full changeover of the front of the car, grill, bumper, lamps, etc. would be necessary. The older snub nosed 9000s had wipers on the headlamps in Europe and other markets but not the U.S. version. If you can locate a source in Canada or Europe that will sell you the necessary components for wipers, you'll need the Euro headlamps, too. The real advantage of the Euro lamp is the availability of higher wattage bulbs, all the way to 90w/130w.*

*The airbag system would not be a feasible retrofit due to the number and expense of components needed to make the system operable.*

*As is the policy of this column, recommendations that any of our fine government agencies would frown upon, are avoided. Look what happened to our friend Bob Sinclair with the East German Wartburg he imported. The fine folks at the NHTSA severely chastised him for such a heinous crime! (They also required that the car be crushed! - TW)*

My 1986 9000 Turbo (92,000 miles) recently developed a peculiar problem with the fuel gauge, it does not read less than one-half even when the fuel tank is nearly empty. The needle on the gauge on the dash remains in the upper half of the fuel level range at all times. The gauge indicates "full" when the tank is full but, the needle does not go below the 1/2 point. I've replaced the fuel level transmitter in the fuel tank and the problem continues. A new fuel gauge, which included the coolant temperature and turbo boost gauges, is over \$300.00. I'd like to not have to replace the gauge.

Mark Searle  
Pleasant Valley NY

*Test the gauge one last time by removing the sender and keep it in the circuit while tilting it and watching the gauge. I don't think you have any alternatives but to replace the gauge. Try locating a used instrument cluster.*

I have an '86 900S whose removable radio/cassette has an intermittent problem. When the outside temperature is warm or the car has completely warmed up, the radio's FM functions perfectly. When the unit is cold, however, the FM produces little or no sound. As the transition from cold to warm proceeds, the radio makes all kinds of screeching and squeaking sounds, then there's a pop! and the unit works perfectly. The wiring appears to be intact.

Gerald Plotkin  
St. Charles IL

*The slide out Clarion can suffer from cracked solder joints where the circuit board joins the row of terminals in the back. These bad solder joints create poor reception, speakers cutting in and out and momentary loss of power supply. If you are not handy with small electronic devices and a pencil soldering gun, send the unit back through SAAB's exchange program or directly to Clarion Service. The address is:*  
25 Commerce Way, Allendale, NJ 07401.

I have a 1987 9000 Turbo (manual transmission) with 91,000 miles. It's been a delight to drive, very reliable, and I'm curious to see just how long before anything major happens. There is, however, one frustrating problem subsequent to turning 25,000 miles. There is a front end rattle (metal to metal sound) related to rapid vertical acceleration of either front wheel and it is localized in the wheel that experiences the movement (washboard roads, bumps, potholes, etc.). The noise seems to temporarily go away whenever the front suspension is unloaded for an hour or two (on the lift while being serviced).

Ralph Summers  
Cupertino CA

*The noise you mention could be brought on by any of the suspension or sway bar mounts and bushings. Have the ball joints been checked for play? If everything checks out, consult your dealer about the SAAB Service Information 04/87-958. This describes revised arm bushing retainers that pre-load the pivot bushings and take up the slack and play in the lower arm. You need two for each side, p/n 89-69-669.*

I have a 1986 SPG 900 that is developing a "howl" between 45 and 60 MPH. I suspect the pinion bearings (or horror of all horrors, the ring and pinion!) are going bad. Since this means and expensive trans overhaul, are there any improved parts and/

or assembly procedures that can be used to prevent a reoccurrence in the future? The car had only 63,000 miles.

Are there any other possible causes I should look into? The noise occurs at steady throttle or increasing throttle. It goes away when you reduce throttle. It's car-speed related, not engine speed. I can hear a separate turbo sound.

Steve Parsons  
Washington IL

*Your howling sounds very familiar. More often than not, the pinion carrier bearings wear prematurely and make themselves known in higher gears and road speeds. It is best to replace the bearings and pinion housings before the bearings wear to the extent that the pinion shaft displaces the geartrain and causes more expensive damage.*

*There are alternative pinion carrier housings available through a few SAAB shops. One is a stronger cast aluminum unit produced by Eriksson Industries, 146B Elm Street, Old Saybrook, CT 06475. The other is a tool steel housing at last word available through J&B Imports, Trollhatten Motors or Nick Pellegrino, all advertisers in the club newsletter.*

*Be sure to use quality bearings and have the gearbox rebuilt by an experienced and knowledgeable SAAB shop. Inspect the countershaft bearings closely. It's best to replace the needle bearings as a rule since the box is already dismantled.*

My '83 4 door 900 Turbo with 5 speed has 120,000 miles on the odometer. Last year, the charge warning light and a "mystery light" to the left of the charge warning light began to come on simultaneously upon start up. These lights continue to illuminate through warm-up idle and stay on until the car is driven away. Upon reaching approximately 1500-1700 rpm, both lights go out. These warning lights always come on at start up, whether the engine is hot or cold and regardless of the weather.

Six months ago, the alternator began to squeal. The squeal persisted and even increased in intensity when additional electrical demands were required. I replaced the alternator with a remanufactured Bosch alternator of stock specifications. The warning lights still illuminated upon start up and still remained lit until driven past 1500-1700 rpm. The squeal ceased, however.

Four weeks ago, the alternator started

### hakkapeliitta snow tires LOWEST PRICES

185/65-15 NR09 mounted &  
balanced on Saab 900 or 9000  
steel wheels \$115.00

	NR.09	Hakka. 10
155x13	\$48.00	\$50.00
165x13	\$49.00	\$51.00
165x15	\$53.00	
185/65x15 Rollsters		\$51.00

While Supply Lasts

#### G & G Service

4073 Hubertus Rd  
Hubertus, WI 53033

414-628-1716

to emit the same squeal sound again. The noise is now increasing in intensity. Is there a wiring fault causing the alternator to wear out? Did I just install a bad alternator? Why would the remanufactured unit not last more than 3-4 months?

Ed Truitt  
Dayton OH

*It is quite possible you got stuck with a rebuilt unit with bad bearings. I would investigate whether the alternator is overworked due to a sulfated battery. The battery may have a loose plate that shorts out and overworks the alternator. Find out what exactly is squealing inside the alternator before you exchange it for another one. Take note of the SAAB Service Subjects in last month's newsletter pertaining to the charge warning light bulb wattage.*

Regarding Richard Cannon's letter in the December '90 issue of NINES, I have the same problem in my 1990 9000CD Turbo which was cured by SAAB in changing a resistor wiring sheath. The man to call is Kevin Smith at 415/429-0388.

Darrell T. Weinman  
Medford OR

*The symptoms Richard Cannon was referring to, an intermittent check-engine light at steady speed, may be related to your 9000's problem. This replacement of the wire harness as a field fix was limited to cars with electronic EGR (exhaust gas recirculation). In 1990, all California spec cars and the SPG had EGR. This may be the case, so thanks for the hint.*

*On this same subject, there have been strange electronic glitches traced to loose grounds at various points on the engine.*

# SERVICE SUBJECTS



## FROM SAAB

<b>Recall 280</b>	GEAR SELECTOR CABLE ATTACHMENT Safety-related Certain 1991 9000 with A/T NHTSA 91V-002
-----------------------	---

### Recall 280, Transmission Selector Cable Attachment

Application: Certain 1991 9000 models with Automatic Transmission

PSI 01/91-0082, Sec.9/pg.2

Saab Cars USA, Inc. has notified the National Highway Traffic Safety Administration (NHTSA) that a defect which relates to motor vehicle safety may exist in certain 1991 Saab 9000 models with automatic transmission.

There is a possibility that, during vehicle assembly, the ball of the automatic transmission gear selector arm may not have been properly fixed to the socket on the end of the gear selector cable. If the gear selector arm should become separated from the gear selector cable at this ball socket joint, the gear position could not be selected or determined by using the gear selector lever inside the passenger compartment. This, in

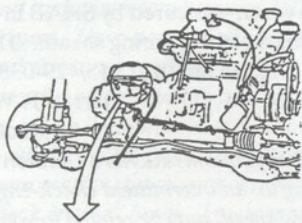

- |                         |                     |
|-------------------------|---------------------|
| 1 Gear Selector Cable   | 4 Selector Arm Ball |
| 2 Gear Selector Arm     | 5 Lock Ring         |
| 3 Selector Cable Socket | 6 Rubber Seal       |

turn, could lead to the possibility of starting the car in a gear other than park or neutral.

These cars will be recalled by Saab to inspect and, if required, properly seat the ball in the cable and socket.

### Vehicles affected by this Recall

9000 models equipped with automatic transmissions that have Vehicle Identification Numbers within the following ranges:

M1004573 - M1007401

M2003031 - M2004955

Approximately 250 vehicles are affected by this recall.

No parts are required for this recall. The ball of the transmission's gear selector arm may not be completely secured in the selector cable end socket due to an excess of grease applied to the socket during assembly.

### Service Campaign

## 349

### Service Campaign to Replace Automatic Trans Oil Coolers

Application: Certain 1991 900 and 900S models with Automatic Transmission  
 PSI 01/91-0076, Sec.2/pg.9

On certain 1991 naturally-aspirated Saab 900 models equipped with automatic transmissions, there is a risk of automatic transmission fluid (ATF) mixing with engine coolant in the water-to-oil transmission cooler. The mixing can occur because of leaks at failed solder joints for the ATF hose connections on the cooler (Figure 1).

- The transmission oil cooler must be

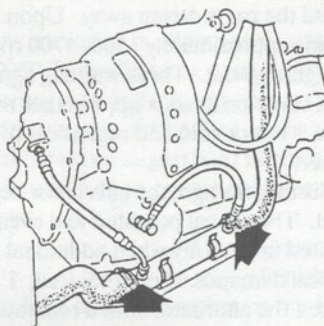

Figure 1. Faulty solder joints at the oil cooler hose connections can cause ATF and engine coolant to mix.

Saab Parts and Service Information updates are provided to NINES as a courtesy to Saab owners by Daniel L. David, director service and technical, and Sten O. Helling, President of Saab Cars USA, Inc.

replaced on all affected cars (see list below). Repairs to the solder joints are not possible and should not be attempted.

- The transmission fluid must also be inspected to determine if the ATF has been contaminated with engine coolant. If the ATF shows signs of engine coolant contamination, the transmission must also be replaced and the engine cooling system cleaned.

Saab sent notices to owners of affected vehicles on or about January 25, 1991. The notice directs owners to make a service appointment to have the transmission oil cooler replaced.

### Vehicles Affected by this Campaign

All naturally-aspirated 900 models with automatic transmission within the following VIN ranges:

M5001517 - M5004420

M7002500 - M7009570

Approximately 1,400 cars are involved in this campaign.

### Parts Required:

Oil Cooler	P/N 75 47 730
O-rings (2)	P/N 79 77 580

### Leakage Inspection Procedure

Before beginning any work for this Service Campaign, check the vehicle's Campaign Modification Plate to determine if the oil cooler has already been replaced. If box A3 is stamped with the figure "3", "6", "7" or "8" no further work is required. If box A3 is blank, proceed with the next step.

1. Inspect the ATF by pulling the dipstick and checking the color of the fluid. A milky pink appearance to the ATF indicates engine coolant has entered the transmission cooling system.
2. Also check the engine coolant expansion tank for signs of ATF contamination. If there is any doubt about ATF contamination, drain and inspect the transmission fluid and, if necessary, remove the front oil pan. Engine coolant that has not yet formed and



emulsion with the ATF may be located in the bottom recess of the pan.

**NOTE**

If there are any signs of engine coolant contamination of transmission fluid, the transmission must be replaced and the engine cooling system flushed. The engine radiator need not be replaced.

**Oil Cooler Replacement Procedure**

1. Drain the engine coolant from the radiator drain plug. Save the coolant.
2. Loosen both oil hoses from the oil cooler (Figure 2). Lift the hoses up and fasten them to prevent oil spillage. Removing the air cleaner housing will provide better access to the oil cooler.

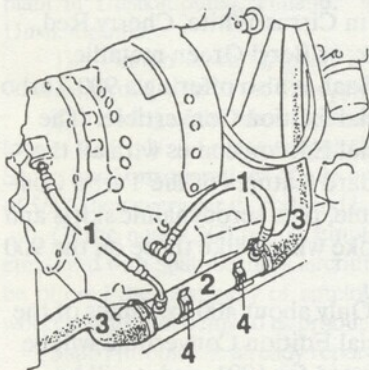

1. Cooler Hoses
2. Oil Cooler
3. Radiator Hoses
4. Mounting Clamps

Figure 2.

3. Loosen the hose clamps that fasten the lower radiator hose to the cooler and remove the cooler. Transfer the rubber mounting strips to the new cooler (Figure 3).
4. Fasten the two radiator hose ends to the new oil cooler and tighten the hose clamps. Note the arrow on the cooler indicating correct orientation (Fig. 3).

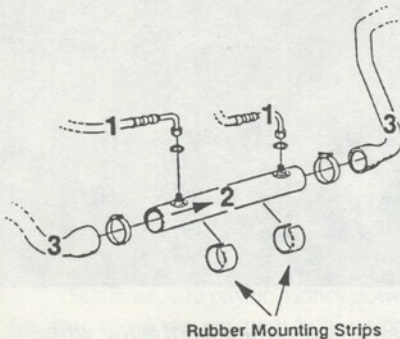

Figure 3. Note the arrow on the oil cooler showing correct installation orientation.

5. Fit new O-rings, P/N 79 77 580, to oil hose ends and connect both oil hoses to the cooler. Push the cooler down into the mounting clamps.
6. Refill the engine coolant and bleed air from the system.
7. Check for leaks at all hose fittings.

**Corporate Emblem Replacement Program**

Application: 900 and 9000 models, 1985-88  
PSI 01/91-0080, Sec.8/pg.14

Saab Cars USA is initiating a program to replace any corporate emblem (hood and/or rear trunk lid) where the color layer has failed to adhere to the disc. 1985-88 900 and 1986-88 9000 models are the most likely to experience this problem. Improve-



ments to the manufacturing process for the emblems were later implemented that eliminated this occurrence.

**Parts Required:**

Hood Emblem	900, 9000	P/N 69 11 895
Rear Emblem	900 4-dr	P/N 69 41 272
Rear Emblem	900 3-dr	P/N 69 41 264
Rear Emblem	9000	P/N 69 63 367

**NOTE**

The rear emblems listed above are the larger diameter size emblems that were introduced for the 1988 model year (9000 - 38mm, 900 - 50mm). Because these larger emblems supersede the smaller ones, the only replacement emblem available for 1985-87 models is this slightly larger design.

**Warranty Information:**

Regardless of the age or mileage on the car, the replacement of peeled emblems will be covered by warranty.

**Airflow Components**

Application: 900 3-door, 1987-  
PSI 01/91-0084, Sec.19/pg.23

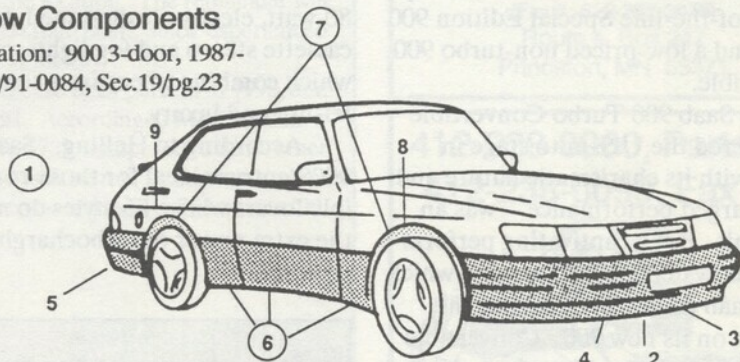

Pos.	Part number	Qty.	Description
1	02 74 910	1	Front and rear spoiler set
2	02 43 071	1	Bottom Skirt
3	02 77 525	1	Front spoiler (with hardware)
4	02 77 541	1	Towing eye
5	02 77 566	1	Rear spoiler (with hardware)
6	02 74 928	1	Side skirt set (same as SPG)
7	02 45 365	1	Wheel arch flare kit
8	02 45 415	1	LH front flare
8	02 45 407	1	RH front flare
9	02 45 399	1	LH rear flare
9	02 45 381	1	RH rear flare
7	02 74 936	1	Wheel arch flare kit (discontinued)
8	02 77 590	1	LH front flare
8	02 77 608	1	RH front flare
9	02 77 616	1	LH rear flare
9	02 77 624	1	RH rear flare



*Naturally-aspirated 900S Convertible will compete with BMW's 318i*

## Saab uncovers two new Convertibles

The Chicago Auto Show was the scene for the introduction of two new convertible models to the Saab lineup -- a top-of-the-line Special Edition 900 Turbo and a low-priced non-turbo 900 Convertible.

The Saab 900 Turbo Convertible that entered the U.S. auto stage in 1986 -- with its charismatic nature and turbocharged performance -- was an instant hit. But a captivating performance usually demands an encore, which is why Saab Cars USA, Inc. put the spotlight on its new 900S Convertible at the Chicago Auto Show in early February.

"Given the new Saab entry's introductory price of \$27,995, the naturally-aspirated 900S Convertible is sure to play a leading role in the highly specialized open-air segment of the U.S. car market," said Sten Helling, president and chief operating officer of Saab Cars USA.

Like the 900 Turbo Convertible, the new 900S Convertible features a fully-lined, electrically-actuated soft top with a glass rear window, which includes a rear window defroster. Although it takes advantage of the 900's basic design platform, the new 900S model is built from the ground up as a convertible and is generously

equipped with standard amenities such as leather seating surfaces, central locking, dual-heated power mirrors, an 80-watt, electronically-tuned AM/FM cassette stereo and fog lights; all of which combine to ensure a sense of leisure and luxury.

According to Helling, "Saab's new 900S entry is ideal for those convertible lovers whose lifestyles do not need the extra power of turbocharging, and

whose budgets require that they stay below the recently-enacted luxury tax on cars priced over \$30,000."

The new 900S Convertible is powered by the same 2.1-liter, 16-valve engine as the other naturally-aspirated 900s, and it is covered by Saab's 6 year/80,000 mile limited warranty, which includes bumper-to-bumper coverage for 3 years/40,000 miles, and automatic enrollment in Saab's Roadside Assistance Program. Saab's patented anti-lock braking system (ABS) and a driver's side airbag are among the long list of standard features.

Saab's 900S Convertible is available in Cirrus White, Cherry Red, Black, or Beryl Green metallic.

Saab is also offering a 900 Turbo Special Edition Convertible. The Special Edition comes with all the standard features of the Turbo Convertible, plus aerodynamic skirts and 3-spoke wheels like those on the 900 SPG.

Only about 400 examples of the Special Edition Convertible will be imported for 1991, and it will be available in only two colors, Platana Grey and Monte Carlo Yellow. The Special Edition 900 Turbo Convertible is priced at \$34,795.



*The Special Edition 900 Turbo Convertible sports 3-spoke light alloy wheels, Pirelli P-600 195/60 VR 15 tires, and aggressive lower body fairings. Only 400 will be available in the U.S. this year.*

**SAAB NEWS**

**Saab Automobile closes new Malmo factory**

After only eighteen months of operation, Saab Automobile AB has closed its newest assembly plant. The facility in Malmo, Sweden, had been built to replace an outdated factory in nearby Arlov. Saab will take a 1.4 billion kroner (\$255 million) loss for the shutdown.

Production of Saab cars will be concentrated in one facility, the original factory at Trollhattan. 900 assembly will take place on one of Trollhattan's two assembly lines, with 9000s to be assembled on the other. The Trollhattan factory had been building only 9000s since 1987.

This allows for better utilization of the Trollhattan plant, which, according to David Herman, president of Saab Automobile AB, should be capable of producing over 125,000 cars a year. Total 1990 production of Saab cars was 87,356 units across three plants - Trollhattan, Malmo and Uusikaupunki.

The 900 Convertible models will continue to be built at the Saab-Valmet assembly plant in Uusikaupunki, Finland. 900s for the Finnish market will also be built in Uusikaupunki.

The Finnish assembly plant is also being converted to build the Opel/Vauxhall Calibra. Production of the European GM coupe is expected to begin this summer.

The closing of the Malmo plant will be a money saver for Saab, which posted a total loss of 4.65 billion kroner (about \$852 million) in 1990. *Automotive News* estimated Saab's loss from operations of 3.25 billion kroner (about \$596 million) amounted to a loss of \$6,700 on every car it produced last year.

Of the nearly 900 people employed at the Malmo facility, about 140 will remain employed with Saab-Scania's aircraft divisions in the same location. The remainder will be offered the possibility of employment at the Trollhattan plant, since experienced workers will be in demand as production is shifted to that factory.

Saab Automobile already reports a productivity increase of 25 percent in 1990, and expects productivity to increase another 20 percent in '91. According to Mr. Herman, it took in excess of 100 hours to produce a new Saab car in 1989, compared to most other European manufacturers which could build a car in 40-45 hours. A Japanese plant requires less than 30 hours to build one car. Saab's figure was reduced to 85 hours in '90, and should be around 60 hours by the end of this year.

**1990 U.S. Sales Totals**

900 (base)	4,640	
900S	6,048	
900 Turbo (incl SPG & Convertible)	6,667	
SPG	743	
Convertible	2,979	
<b>900 total</b>		<b>17,355</b>
9000 (base)	196	
9000S	3,250	
9000 Turbo	5,444	
(includes CD)		
<b>9000 total</b>		<b>8,890</b>
IDS European delivery (models not specified)	152	
<b>Total U.S. Saab sales, 1990 calendar year</b>	<b>26,397</b>	

**Saab offers special purchase and lease plans on '91 models**

You can now buy or lease a new Saab 900 for \$299 a month, or a new 9000 for \$399 a month, through a special financing plan offered by Saab-Scania Financial Services Corp.

On a lease, you pay no money down and the lease period is 36 months. To purchase, the required down payment is 20 percent, and the financing period is 48 months. The payment figures given are on the lowest priced Saab 900s and 9000s.

For complete details, see a Saab dealer.

**andrews**

INC. OF PRINCETON

**EXCLUSIVELY SAAB**

612 / 389-3805

**March SAAB Specials**

Hatch lift shocks, OEM, 99/900 \$25.00

\*\* These are especially prone to cold weather failure. Get some now and avoid a nasty bump on the head! \*\*

Trailer hitches, removable drawbar  
900/9000 \$150.00

Headlight covers, 900/9000 \$45.00

\*\* With headlights ranging from \$130 to \$240 for the Euro style, these covers can save you lots of \$\$\$. \*\*

Mann/Saab Oil filters, V4 thru 9000 \$3.59

\*\* Did you know that Mann makes the Saab Oil filter that costs so much at the dealer? Blue paint must be expensive! \*\*

**VISA/MASTERCARD ACCEPTED**

Check us out on Used Parts, too.

All prices plus shipping

**Twin Cities Metro line: 444-6868**

Toll Free National Parts Line:

**1-800-882-7220**

(Fax#: 612-389-3875)

Route 4, Box 247

Princeton, MN 55371

**412-238-0900, Parts line**

**412-238-0099, Fax line**

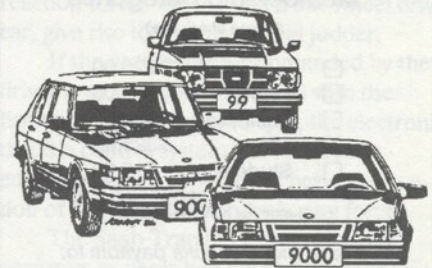

**DENNIS SWEENEY**

ROAD TESTED SAAB PARTS

RD 1, Box 410,

Ligonier, PA 15658

Buying SAAB parts cars and late-model rebuilders every month.

- Computerized inventory -  
Same day shipping on most items.

Used mechanical and electrical parts, interiors, accessories, sheet metal, rebuilt steering racks, wheels, heads, transmissions.



Saab supplements the windshield wiper/washer systems on all 1991 models with headlight wipers and washers as standard equipment. Just as a car's windshield can be obstructed by dirt, snow and slush, the performance of a car's headlights can often be diminished due to the accumulation of road dirt and grime, making nighttime driving even more taxing. Saab's headlight wipers and washers function automatically when the windshield washer is activated.

Saab pioneered the use of headlight wipers in 1972 on the Saab 99. They are now required equipment in many European countries.

## Saab shows new ozone friendly AC system

Saab is the first automaker to unveil a newly-developed air conditioning system containing an ozone-friendly refrigerant called HFC-134a. The new refrigerant contains no chlorinated fluorocarbons (CFC's), and will soon be incorporated into the Saab 9000.

Authorities world-wide have proposed a ban on products that use CFC's, which are said to have a detrimental effect on the earth's ozone layer. Sweden and Germany have bans on CFC's that go into effect in 1995. Several states in the U.S. have similar laws which will take effect in the next few years. HFC-134a contains no chlorine atoms as does the current refrigerant, R-12.

A Saab 9000 with the new air conditioning system was on display at the 1991 Salon International de l'auto Geneve, Geneva, Switzerland.

9000s with the new system utilizing HFC-134a will go on sale in selected European markets this Fall. 12,000 Saab 9000s destined for Norway, Denmark, Finland, Switzerland, Germany, and Sweden. It will be incorporated in 9000s with both automatic climate control systems (ACC) and manual air conditioning.

Saab is currently investigating the commercial availability of HFC-134a throughout the world to determine specific introduction strategies and timetables for other markets.

## Wallenberg group to buy Saab-Scania AB

Investor Providentia, also known as the Wallenberg group of Sweden, has bid to take a majority interest in Saab-Scania AB. The group offered \$2.28 billion for 50.8 per cent of Saab's voting stock and 59.2 percent of capital shares. The takeover was unanimously endorsed by Saab-Scania's board of directors. The move is not expected to cause any change to the automotive operations.

Investor Providentia already owns slightly more than 40 percent of the shares and almost 50 percent of the votes.

Peter Wallenberg is chairman of the Wallenberg group, which holds stock in many of Sweden's large companies, including SKF, Electrolux, and Hasselblad.

"The offer demonstrates the confidence in the long term potential of Saab-Scania," reported a spokesman for the Wallenberg group.

(from *AutoWeek* 3/11/91)

## N. J. dealer tops '90 sales list for 6th consecutive year

Ramsey Saab of Ramsey, New Jersey, was the top-selling Saab dealership in the United States during 1990, according to William S. Kelly, vice president, sales and marketing for Saab Cars USA, Inc.

The New Jersey dealership retailed 435 new Saabs in 1990, and has had the highest Saab sales volume of any Saab dealer in America every year beginning in 1985.

Second place in the 1990 sales ranking was claimed by Zumbach Motors, Inc., of New York City with 367 units, followed by Saab of Westport, Westport, Connecticut, with 313 sales. Rounding out the top five 1990 Saab sales leaders were Fields Saab of Glenview, Illinois, with 300 sales, and Clews & Strawbridge of Frazer, Pennsylvania, with 294 new Saabs sold.

## Saabs on film

Saab cars have been seen more often recently in movies and television shows, thanks in part to a company in California, International Media Promotions, that specializes in placing cars in movies.

Saabs play an important part in the current Woody Allen/Bette Midler film, *Scenes from a Mall*. A 900 Turbo Convertible is used in several scenes.

Angie Dickenson played a New York policewoman who drove a 900 in *Prime Target*, a recent made-for-TV movie. Her car is blown up by "the bad guys" as Angie gets close to figuring out who they are. In reality a 9000 that had been written off was destroyed as a stand-in for the 900.

Cybill Shepherd is seen behind the wheel of a 900 in *Chances Are*, on the cable TV circuit in the past few months.

Become a member of the  
**National Motorists Association**

### Membership Categories

(Please check one)

- Individual \$25.00
- Family \$35.00
- Business \$60.00
- Life \$325.00
- Student \$15.00

\$12.00 of your dues goes towards your  
Bi-monthly NMA newsletter

Please make checks payable to:  
National Motorists Association  
6678 Pertzborn Road  
Dane, WI 53529

We also accept MasterCard or VISA  
Call toll free

**1-800-882-2785**

Please Print Clearly

Name \_\_\_\_\_

Address \_\_\_\_\_

City \_\_\_\_\_

State \_\_\_\_\_

Zip \_\_\_\_\_

Phone \_\_\_\_\_

space provided by the SAAB Club of North America

## Swedish Motors, Inc.

Essex & Decatur Streets  
Marietta, PA 17547  
717 - 426-2202



COMPUTERIZED INVENTORY OF  
NEW & USED SAAB & VOLVO PARTS

Best Prices on used engines, body,  
trans, interiors, glass & more

*Oldest Nokia Tyre Dealer in U.S.*

VISA/MC Accepted - UPS Shipping Daily

## Saab's Traction Control System offers safer motoring and better mobility

The Traction Control System (TCS) represents Saab's way of preventing wheel spin when a car is accelerating on a slippery road surface, and of ensuring improved stability during normal motoring. The system is based on the Saab ABS+3 anti-lock brake system, in intelligent combination with an electronic throttle control system.

The purpose of the Saab TCS is to improve the mobility of the car by controlled application of the anti-lock brakes to the driven front wheels, but without reducing the engine speed while the car is travelling at low speeds. This is the feature that distinguishes the Saab TCS from conventional anti-spin systems which merely throttle down the engine. At speeds above 25 mph (40km/h), the TCS controls the tractive force by means of the electronic throttle control system, although to a decreasing extent as the speed of the car increases. In addition, the Saab Traction Control System minimizes wheel spin, so that handling will be stable even when the car is accelerating while cornering on a slippery surface. The Saab TCS performs equally well when the car is reversing, since the sensors record wheel spin regardless of the directions of travel.

### Saab Traction Control System

The hallmark of current automotive development is the ever-expanding application of electronic systems.

Microprocessors and sensors enable various processes to be controlled quickly and accurately. Engine management systems, for instance, ensure optimum utilization of the fuel by accurate control of various engine parameters.

In the next major development stage, electronics will be used for controlling the system of forces handled by the chassis - the steering, braking and acceleration forces.

The Saab Traction Control System adds very little weight to the car and causes no energy losses. By intelligent control of the brakes and throttle, the system improves the motoring safety of high-power cars, and ensures the same mobility properties as a differential brake, although offering superior handling and better steering precision. This is particularly true on a front-wheel drive car, since it is the same pair of wheels that drive and steer the car.

Under split-friction conditions - when the friction between the road surface and each of the driven wheels is different - the

TCS provides better mobility than a simple 4-wheel-drive system, although it cannot offer the same gradability as an advanced 4WD system.

Operation of the Saab TCS is based principally on the equipment already included for the Saab ABS+3 anti-lock brakes - wheel sensors, electronic control unit and central unit with high-pressure pump and valve unit. The only additional components of the TCS are two control valves and the electronically controlled throttle.

Conventional anti-spin systems used in the past were based on merely reducing the engine power. The Saab Traction Control System prevents spin while maintaining full engine power when pulling away.

The Saab designers' brief was to develop a system that maintains good tractive force immediately after starting, regardless of the road friction conditions. This can be achieved only by employing interactive use of the brakes and throttle.

Under split-friction conditions, the brake is applied to the wheel which is the first to lose its grip, thus allowing the other wheel to exert additional tractive effort.

### No steering-wheel judder

This arrangement provides the same mobility improvement as a differential brake. But the Saab TCS causes no reaction forces which, on a front-wheel drive car, give rise to steering-wheel judder.

If the acceleration commanded by the driver is so high that the wheel with the firmer grip also begins to spin, the electronic throttle control system will reduce the engine power to provide the best combination of tractive effort and steering force.

The Saab Traction Control System performs as described above at speeds up to 25 mph (40 km/h). In brief, the brakes are controlled by the driven wheel which has the lower friction - known as "select low" in engineering parlance - whereas the engine is controlled by the driven wheel with the higher friction - or "select high".

### Pulling away uphill without stalling

When starting on an uphill gradient under split-friction conditions, braking effort is applied gradually to the spinning wheel. The effort is roughly the same as when the driver slips the clutch to pull away smoothly without stalling the engine.

Wheel sensors continually monitor and compare the speeds of the driven wheels,

TRACTION CONTROL SYSTEM (TCS)  
WITH ELECTRONIC THROTTLE SYSTEM (ETS)

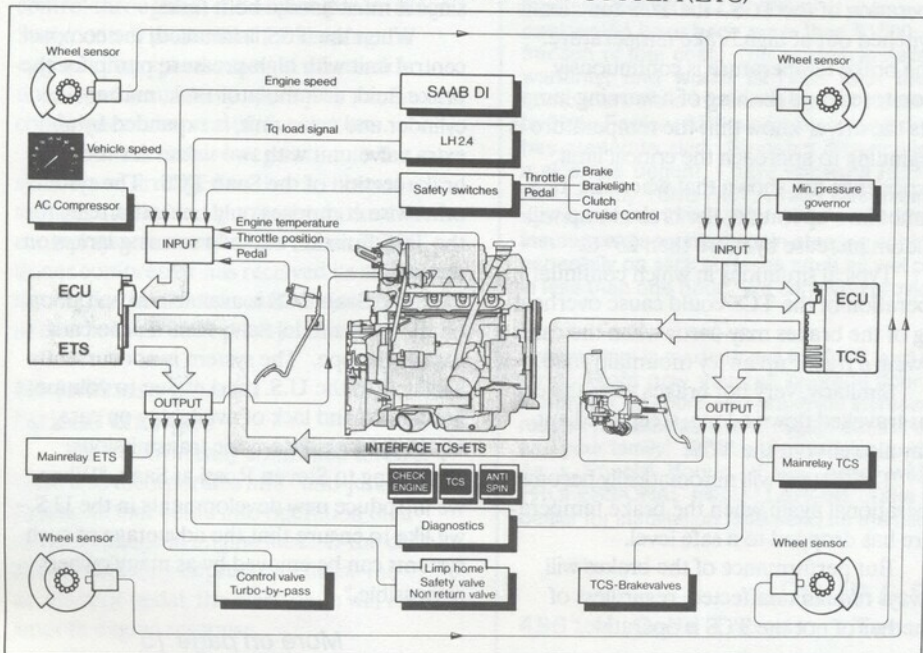

1. Front brakes
2. Rear brakes
3. Electronic control unit for TCS and ABS+3
4. Electronically controlled throttle valve
5. Electronic control unit for the throttle valve
6. Central unit for TCS/ABS+3, including pump, accumulator, master cylinder and valve unit (the valve unit for TCS is exposed)

and will provide information whenever one of the wheels has lost its grip and is spinning. The control unit processes the speed signal and takes the necessary corrective action.

### Better acceleration on a slippery surface

Since wheel spin will not cause immediate reduction in engine power at road speeds up to 40 km/h, the Saab Traction Control System provides better acceleration under slippery road conditions than a conventional anti-spin system.

Due to the combination of front-wheel drive and the Saab TCS, scope is available for more responsive setting of the anti-spin control system, but without affecting stability.

### Importance of stability

The operating principle of the Saab TCS gradually changes at road speeds above 40 km/h (25 mph). Instead of giving priority to the select-high principle as at lower speeds, the system changes over to select-low operation for best possible stability. In other words, the system reacts to the wheel which is first to lose its grip.

If a driven wheel should begin to spin, the throttle will be reduced automatically by the electronic throttle control system.

### Safer cornering

This ensures good steerability on a slippery surface, since no additional tractive force is transmitted to the other wheel when the car is cornering. So the other wheel will have ample margin for taking up steering forces. The driver will never have to face the shock of the front suddenly breaking away due to too much engine power.

Saab has given priority to high stability at speeds up to about 90-100 km/h (around

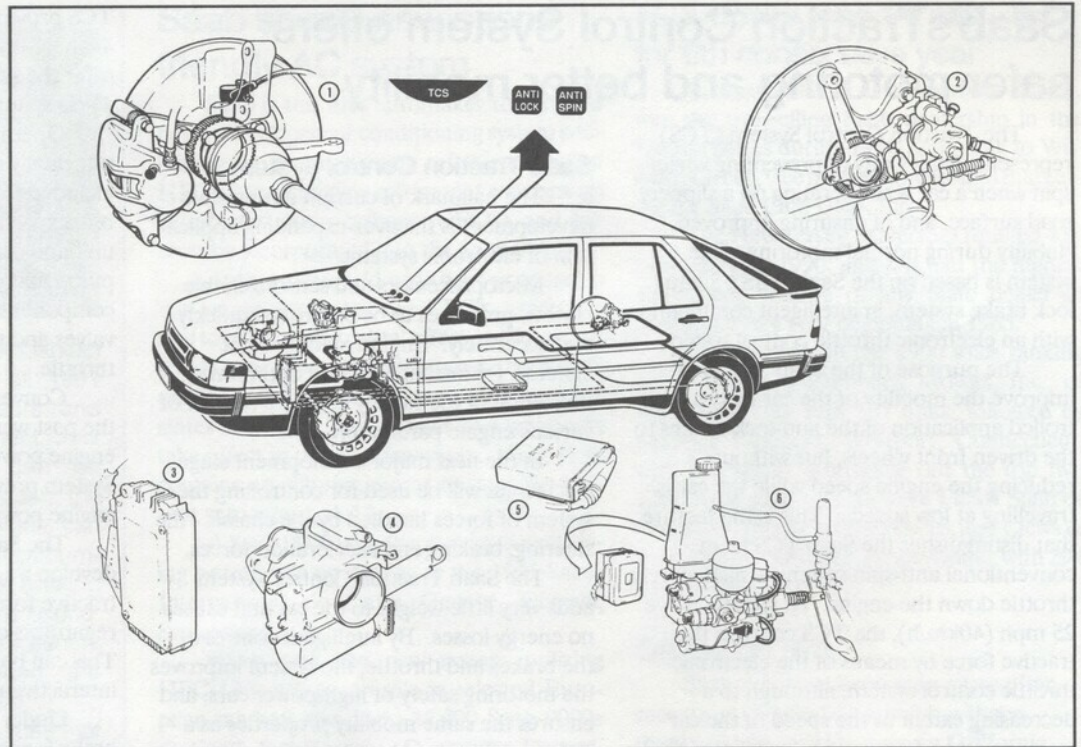

60 mph). At higher speeds, the sensitivity of the system gradually decreases. This allows scope for sporty driving, but without the stability being impaired and without engine power being unnecessarily throttled on an uneven road surface.

### Overheating protection

To eliminate all risk of overheating the brakes - either by ordinary braking or by operation of the TCS - the TCS function is switched out at high brake temperature. The brake temperature is continuously monitored, and flashing of a warning lamp lets the driver know that the temperature is beginning to approach the critical limit. Experience has shown that when the TCS comes into operation, the brake temp will seldom increase by more than 25° C.

Typical situations in which continual operation of the TCS could cause overheating of the brakes may occur when the car is towing a trailer up an icy mountain road.

Similarly, very hot brakes after the car has travelled down a long, steep gradient may also cut out the TCS.

The system will automatically become operational again when the brake temperature has dropped to a safe level.

But performance of the brakes will always remain unaffected, regardless of whether or not the TCS is operative.

### Many common components

The Saab Traction Control System is based principally on using the equipment already included in a car with the Saab ABS+3 anti-lock brake system. The sensors in the wheel hubs are common to the two systems, and so is the electronic control unit. But the electronic control unit of a car equipped with both ABS+3 brakes and the Saab TCS will be somewhat larger, since it must handle both tasks.

When the TCS is installed, the compact central unit with high-pressure pump for the brake fluid, accumulator tank, master cylinder and valve unit, is expanded by an extra valve unit with two valves for the brake section of the Saab TCS. The system otherwise comprises only one extra relay for the TCS function and two warning lamps on the fascia.

The Saab TCS is available as an option on the 1991 model Saab 9000 Turbo cars sold in Europe. The system is not currently available in the U.S. market due to volume limitations and lack of availability on cars equipped with automatic transmissions. According to Steven Rossi at Saab, "When we introduce new developments in the U.S. we like to ensure that the advantage of such systems can be enjoyed by as many owners as possible."

*More on page 15*

## Throttle cable gives way to electronics

The electronically controlled throttle valve is one of the vital subsystems of the Saab Traction Control System. Due to electronic control of the throttle, the conventional cable between the accelerator pedal and throttle valve is retained only for emergency situations. Its normal function has been taken over by an electric motor which is controlled by an electronic control unit.

The principal benefits of electronic throttle control are improved driving comfort and scope for integrating a number of functions. In addition to other benefits, the system simplifies service, maintenance and fault tracing.

Saab's electronically controlled throttle valve is an important component of the Saab Traction Control System (TCS) which can apply signals to reduce automatically the throttle opening whenever necessary.

However, electronic throttle control incorporates other functions and offers additional benefits which jointly improve the driving comfort. Moreover, several different functions have been integrated into a simple, intelligent system.

### Automatic idling control

The electronically controlled throttle valve eliminates the need for separate equipment for automatic idling and load control throughout the engine power range. Such control is essential for keeping the engine idling speed constant when additional load is suddenly applied by the air conditioner compressor, for instance.

This function is integrated into the system and arranged so that an "increase" signal is applied to the electronic throttle control system even before the air conditioner compressor has received its starting signal. So this throttle control system can be said to have an anticipatory function.

### No jerkiness caused by load changes

The electronically controlled throttle valve also incorporates an "anti-jerk function" that comes into operation on a sudden change in engine load. If the driver should suddenly depress or release the accelerator pedal, the electronics will ensure smooth engine response.

Without the electronic system, jerk-

iness would often be felt in the drivetrain due to movement of the power unit. On a car with electronically controlled throttle, the throttle valve will open in two steps over a period of a few milliseconds, which prevents jerkiness and promotes smooth response.

### Simplified emission control

Electronic control of the throttle valve eliminates the need for a separate dashpot in the fuel injection system. The dashpot controls the engine speed reduction when the driver takes his foot off the accelerator, and is operative until the engine speed has dropped to idling. This ensures satisfactory performance of the emission control system.

### Integrated cruise control

Electronic throttle control incorporates a cruise control function. So no additional components are necessary to equip the car with a cruise control system.

In addition, the cruise control function contains a "tip up/tip down" function, whereby the driver can increase the road speed of the car in steps - tip up - by briefly depressing the SET button. The driver can also reduce the speed of the car by quickly depressing the RESUME button - tip down.

If Traction Control System becomes operative when the car is running on cruise control, the latter will be smoothly disengaged as a safety measure.

### Self-adjusting system

The electronic throttle control system is adaptive, i.e. self-adjusting. So it automatically adjusts itself for atmospheric pressure, ambient humidity and possible wear of the components.

It obviously incorporates automatic increase of the idling speed during warming-up, controlled by the time elapse and the coolant temperature.

The system receives and processes information from the speedometer, the ignition system (Saab DI), the TCS, the fuel injection system and the engine temperature sensor. In addition, it continually monitors the positions of the throttle valve and accelerator pedal. The electronic control unit converts this information into signals to the electric motor which controls the throttle valve opening.

The system incorporates a fail-safe function, whereby the throttle cable will become operative if the electronic system should fail.

## !! RETROFIT ANTI-SKID BRAKES !!

**Now you can BOLT-ON ABS!!!** If your car was available with ABS from the factory, the extra cost would have been more than \$1500. Now you can retro-fit a better type of ABS for a fraction of that cost. This system installs in less than 30 minutes, DOES NOT affect your warranty, and works **BETTER** than the factory ABS. Brake fade disappears, brake component life is increased by more than 100%, and stopping distance is decreased by up to 30%. Factory ABS works by cutting down braking pressure when it senses that a wheel has started to skid. Stopping distance is **INCREASED**, and the system only works when a skid has begun! I have shown a **REDUCTION** in stopping distance of 32 feet from 60 MPH on my Volvo 740T, which was already running Repco pads and stainless lines! Our system works **ON EVERY STOP, BEFORE** a skid develops! The system **qualifies for ABS insurance discount**. Regain steering control during panic stops, increase braking efficiency, especially on slick surfaces such as wet pavement or cement. Will transfer to your next car in less than one hour. We can even provide a step-by-step installation video **AT NO COST!**

This system is made to sell for \$675, and most new car dealers are charging \$895 to \$1295 for it. Right now you can upgrade your braking system through us for **only \$549**. The insurance discount and brake life increase will pay for that in almost no time. But the real reason to install ABS is to regain control of your braking. Think of the added safety for you and your family! What is their safety worth? **ORDER NOW at our INTRODUCTORY PRICE.** As a Special Bonus, If you order within the next 30 days, **WE WILL PAY FOR A PROFESSIONAL INSTALLATION!** Take your ABS system to your favorite mechanic or dealer for installation, and send us the bill! (Details with purchase) **ACT NOW AND SAVE!**

### GROUP 6 PERFORMANCE

4961 N. Calle Tobosa Tucson, AZ 85749 (602) 749-1809



## A 4-wheel favorite among 2-wheel fans

Those who occasionally prefer traveling by pedal power as opposed to horsepower usually choose a car that allows them the versatility to transport their bicycles safely to faraway events and scenic places. To many, a car is the fundamental four-wheel means to the open-air end of two-wheel bliss.

Saab realizes the distinct needs of its customers and designs its full range of products with both practicality and enjoyment in mind.

*Bicycle Magazine*, for example, recently named the Saab 900 hatchback as one of its "Top 10 Cars for Cyclists." The 900 hatchback features a fold-down rear seat which offers some 56.5 cubic feet of cargo capacity. To a biking enthusiast, this means secure transportation for two bicycles without removing the front wheels, plus additional storage space for a cooler, sleeping bags, tent, and even luggage.

Saab 9000 hatchback models are bicycle friendly too. Their cargo capacity can be expanded from the generous trunk of a comfortable sedan to the impressive cargo bay of a station wagon -- without compromising passenger comfort. Also the lift height of the car's luggage compartment is low and the floor is completely flat, which facilitates easy loading of bicycles and other gear.

Another alternative for all 9000 and 900 models is to carry bicycles on the vehicle's roof by mounting an optional Saab roof rack. Saab bike holders and locks are available through any of Saab's U.S. dealers. Other Saab-approved accessories which are ideal for biking excursions include a cargo mat to protect the car's cargo compartment from dirt and other road debris; storage boxes, which attach easily with velcro to the side of the luggage compartment and keep small, loose items contained; and horizontal or vertical cargo nets to hold sport bags or lightweight items in place. Another item that Saab dealers can provide is a First Aid Kit approved by the American Red Cross, handy in case of a biking mishap.

### Bicycling Safety Tips

In view of the many biking accidents that occur each year, Saab has compiled the following safety tips to ensure biking safety and recreational enjoyment. Motorists should also be aware of these tips to avoid an accident with a bicyclist:

#### Be Seen

When bike riding, wear bright clothing in the day and light colored clothing at night to help others see you. Wearing a helmet will protect your head and also cut down on glare.

A bicycle headlight, taillight, and reflectors are extremely important for night and sometimes day riding.

Your shadow can be your key to danger when riding at night. Cars can easily overtake

a bicyclist. When this happens the approaching cars' headlights will cast your shadow directly in front of your bike. Be prepared and alert! Swift action may be required of you to avoid a collision.

### Intersections

There are three common dangers from traffic at intersections:

1. When turning left, a car will find a gap in the line of traffic, discovering too late that it contains a bicyclist.
2. When turning right, a car will often not notice the bicyclist who has pulled along side and will proceed to turn right without being aware of the biker's presence.
3. When at a stop sign, a car will check for traffic and often not notice a bike traveling the through street.

### Keep Right

Always ride your bicycle on the right side of the road -- with the flow of traffic -- not against it. Stay far enough from the curb to avoid car doors opening, drains, soft shoulders, broken glass, and other hazards. And always ride single file.

### Ride Defensively

Always look back before changing direction. Obey all traffic regulations, signs, signals and markings.

Use hand signals to indicate turning or stopping.

Don't make any sudden moves while in traffic.

Always yield to traffic.

Never hitch a ride to a car or truck.

Don't carry passengers!

### Safety Equipment

#### All Bikes Should Have

- Horn or bell.
- Pedal reflectors.
- Red rear reflectors.
- White front reflector.
- Front light.
- Red or colorless spoke reflector on the rear wheel.
- Amber or colorless spoke reflector on the front wheel.

### Proper Maintenance

A properly maintained bicycle will provide the optimum riding and safety performance.



## Are you comfortable?

### Tips on how to avoid seat fatigue

With 137 million automobiles on the road today, Americans spend more time driving their cars than anyone else in the world. According to the U.S. Department of Transportation, each American logs more than 10,000 miles behind the wheel each year. While that only averages about one hour each day, it quickly adds up to more than 400 hours a year -- a whopping 18,000 hours over a lifetime!

Saab-Scania, the Swedish automaker, realizes the enormous amount of time its customers spend in their cars and has devoted resources over the years to design seats that are not only comfortable, but more importantly, orthopedically sound.

Sten Helling, president of Saab Cars USA, Inc., sums up the importance of seat design. "There are many components to building safe, comfortable cars," he says. "But if a driver isn't comfortable and well supported, he will grow tired much more quickly and suffer from muscle aches, stiffness and discomfort. Naturally, that impedes his ability to drive safely, despite any other advanced engineering features."

Buying a car with superior seat design is not enough, says Terry Moule, N.D., D.O., one of Europe's leading osteopathic consultants and sports injury specialists. "Despite the amount of time Americans spend in their cars, they have not been taught how to use seats correctly, and therefore don't spend the necessary few minutes to achieve the correct driving position. It's easier to blame your aching back on your car seat design, rather than take the time to learn all the benefits of well designed car seating, and adjust the seat until it fits you properly."

Mr. Moule, who has treated British Olympic athletes and the Australian Davis Cup squad, and is the official sports injury consultant to the English Table Tennis Association, offers the following tips to properly adjust the seat before any drive:

1. Move the seat up or down until the top of your hip line is just below the lowest part of the steering wheel.
2. Adjust the seat forward or backward until the clutch can be depressed without lifting your buttock off the seat cushion.
3. Make sure there is comfortable support under the thigh. Ensure that

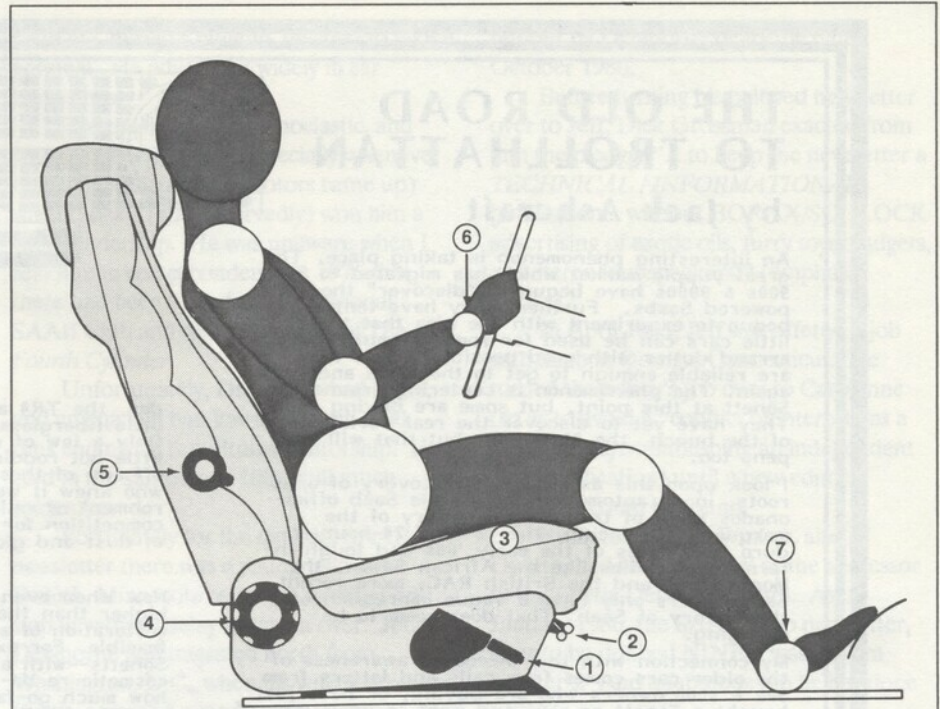

Sitting comfortably is a matter of sitting correctly... Take an extra minute to adjust your seat; not only will the ride be safer and more comfortable, it will help you avoid back pain, too. Using this illustration of a Saab seat here's how: Adjust the seat height (1) and its distance from the dashboard (2); also make sure you have proper support under your thigh (3).

Next, sit completely back and adjust the angle of the seat-back (4), and the lumbar support (5).

Finally, adjust the steering wheel until your arms are slightly bent (6), and plant your feet firmly against the gas pedal and the dead pedal of the car (7).

no heavy pressure is created while depressing the clutch. The longer your legs, the more front support you will require when driving.

4. Sit completely back and adjust the angle of the seat-back until the whole length of your back is pressing against the back rest. If you sit too upright, your body's center of gravity will put too much stress on your lower back and upper thighs. Leaning too far back will put stress on your neck and shoulders.
5. Once the seat is on the proper position, adjust the lumbar support until there is a gentle awareness of a supporting pressure in the lumbar area. This should not feel too firm. In fact, many drivers will find that the lowest setting provides the necessary support.
6. Adjust the steering wheel until your arms are slightly bent, with the hands at the "Ten and Two" position.

Mr. Moule admits that this position may feel unusual at first, since many people are unaccustomed to the correct sitting position. It may cause some low back and shoulder discomfort in the early stages, because a correctly set car seat acts as a postural corrective, supplying improved support. However, after five hundred miles or more, you should feel a marked improvement not only in spinal and muscular comfort, but also with general mental alertness and vehicle control.

Mr. Moule also stresses that not all car seats are alike, and that some may not have all the correct adjustment features for the absolutely best position -- while some may have more than you will ever need. Personally, at home in Great Britain, Mr. Moule drives Saabs, and has prescribed Saab driving as a remedy for back problems for many of his patients.

# THE OLD ROAD TO TROLLHATTAN

by Jack Ashcraft

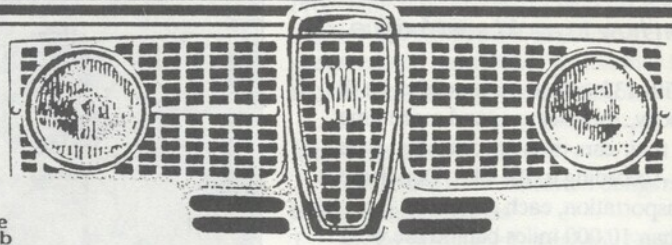

An interesting phenomenon is taking place. The great yuppie market which has migrated to Saab 900s & 9000s have begun to "discover" the V4 powered Saabs. Further, they have tentatively begun to experiment with the idea that these little cars can be used for some commuting or errand duties with good possibility that they are reliable enough to get to the store and back again. The phenomenon is centering around the Sonett at this point, but some are buying 96s. They have yet to discover the real workhorse of the bunch, the 95 wagon, but that will happen, too.

I look upon this as a sort of discovery of ones roots, in an automotive way. While Saab aficionados know of the colorful history of the marque in ice racing, the 12- and 24-hour endurance road races of the early '60s and tough international rallies like the African Safari, the Monte Carlo and the British RAC, more recent Saab buyers only have a vague impression of the history of Saab. That does seem to be changing.

My connection with this increased awareness of the older cars comes from calls and letters from 900 & 9000 owners who are buying, or have just bought a Sonett or a 96 and want to know more of it and where to get parts for it. They have heretofore overlooked these cars in favor of a plastic econobox they use for commuting, thus keeping commute miles off the "good car", the new Saab. In doing research they have discovered some of the colorful past of Saab, to their delight.

Other marques, Alfa, Mercedes, Jaguar, Porsche, have better known histories, and indeed promote their roots in their advertising. Being more involved in race competition, their vintage models are more often featured in salon articles in buff magazines. A glance at a Classic Motorbooks catalog will reveal 15 or 20 books on Porsche, a dozen or so on Jaguar and 3 or 4 on Saab, one of which is nothing more than a compilation of old road tests. This accurately reflects the fact that Saabs have always appealed to a limited, though fiercely loyal few who accepted--no, revelled in--their somewhat kinky, idiosyncratic design features. Think about it. How many amongst the great unwashed could love a 4-speed on the column, free-wheeling front drive and that just-humped-by-a-big-dog look of the 96. Face it, the hot stuff in the mid 60s was a GTO or a Shelby Mustang! The hot selling sports cars were the Fiat 124 Spi-

der, the TR4 and the Datsun 240Z, not a lumpy little fiberglass kit car with a column shift. Only a few of us knew the Sonett V4 with a little hot rodding would suck the very doors off any of those cars at any time. Those of us who knew it went out into a trophy rich environment of rallies and autocrosses and ate the competition for lunch. Ah--those were the days of dust and glory!

Now when even econoboxes are priced slightly higher than the cost of a Tomahawk missile, the restoration of a V4 Saab is becoming economically feasible. For example, one of my fully restored Sonetts--with a bumper-to-bumper mechanical and cosmetic re-do--will go for \$7-9000 depending on how much go-fast equipment is added. You can't even buy a Ford Festiva with air for eight thousand bucks! And fellow Saab nuts, if any of you would rather drive a Festiva than a Sonett, you shouldn't be reading this publication--try Consumers Reports.

I predict more late Saab owners will restore the V4 Saabs, and that pretty soon the utility minded will discover the 95 wagon, which will become the most sought after of the 95/96 siblings. Parts will dwindle, but we will figure out fixes, and the cars will stay on the road. Ownership will shift from the guy who bought a V4 because it was cheap (and who is now appalled about the idea of spending any money on it) to the guy who bought a new Saab for 30 Big Ones and who figures a fully restored V4 for eight is damned cheap. Especially for a car that has real steel in it.

It is exciting to me to see the renewal of interest, not only in the older Saabs themselves, but in the history of the Saab company. Some of us do not particularly care for the path that world economy has forced Saab to travel, but in the end there may be a secondary fall-out--a collateral--benefit to us who love the V4 cars. They will be restored and kept on the road by our so-called yuppie friends who have discovered them and are willing to spend the money on them to keep 'em rolling.

To those new restorers--of the cars and of the faith--I lift my glass of aquavit. SKOL!

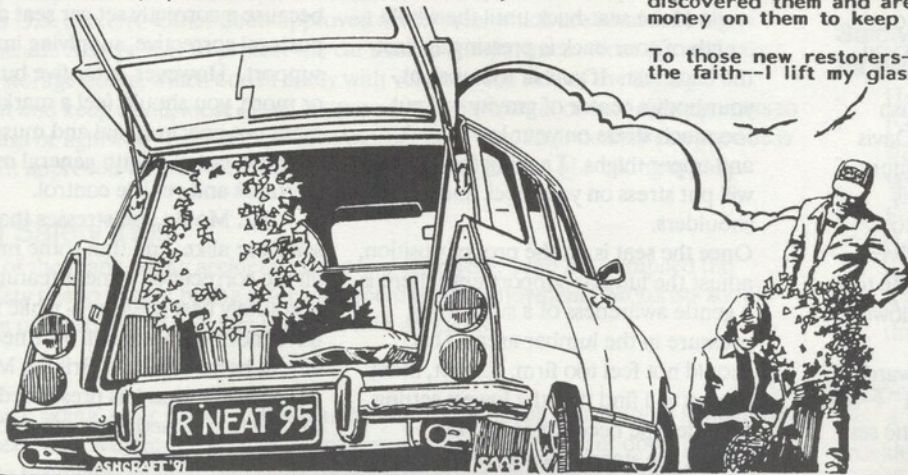

## Delving into SAAB Club history

In researching material for the SAAB Club of the National Capital Area's (SCNCA) thirty-something anniversary of its founding on March 10, I dug into the archives/or historical items which could tell the present generation of SCNCA members something about the past glory of their club.

The snippets about the past recently run in *Smoke Signals*, the club's newsletter, show how the skein of SCNCA history has been intertwined with those of the different national SAAB clubs, through their newsletters.

It is not generally remembered the first SAAB Club of America was centered in the Harrisburg, Pennsylvania area, which is understandable when one realizes the SAAB Club of Harrisburg was one of the earliest, largest, and most active clubs in the country. Its incorporation papers are dated in early 1959. (In 1960, among the new members signed up: "Mr. & Mrs. Robert J. Sinclair from Fanwood, N.J. Bob is Regional Sales Manager at SAAB Motors.")

*The Fourth Cylinder*, the SAAB Club of America's newsletter, was published not much before the May 1964 copy in the SCNCA file. That *Fourth Cylinder* was mailed from Dauphin, which is not far from Harrisburg. It featured sports car activities and news of various clubs.

Publication of *The Fourth Cylinder* and the locus of SCA activity shifted to the Washington, D.C. area in November 1964 when Richard Hansell, organizer of the SAAB Club of the National Capital Area took over as president of the SAAB Club of America and also as editor of *The Fourth Cylinder*. Dick was elected president of SCA at its meeting at the third SAAB Open House at SAAB's headquarters in New Haven, Connecticut in October 1964.

The monthly newsletter under Hansell was booklet size, 6" by 8½", usually 14 pages crammed (by camera reduction) with technical information, tips, automobile lore, news from affiliated clubs, etc., much as NINES now does. *The Fourth Cylinder* flourished until the issue of March/April 1970 when it and the first SAAB Club of America disappeared.

We next pick up the story of a national SAAB newsletter in Chicago. In the fall of 1974, Dick Grossman, editor of the SAAB

Club of Chicago's bulletin, decided to take it national. He advertised widely in car magazines.

Grossman's feisty, iconoclastic, and sometimes venomous (especially whenever the subject of General Motors came up) sheet quickly (and deservedly) won him a wide readership. He was unaware when I told him in correspondence in 1976 that there had been a predecessor national SAAB Club and sent him copies of *The Fourth Cylinder*.

Unfortunately, Dick had a bad heart, and angina laid him low in August 1980, thus ending his tumultuous editorship. He died in the summer of 1989, still much remembered.

Fortunately for the national SAAB newsletter there was a young fellow in Duluth, Minnesota, who was qualified to step in without delay to take it over. Jeff Delahorne had migrated north from Washington, D.C., when his wife, Carolanne Curtis, accepted a biochemist research job there. Jeff gave up a staff job on the Council on Economic Quality in D.C. The first transplanted SAAB Club newsletter

put out by Delahorne bears the date October 1980.

Before turning his beloved newsletter over to Jeff, Dick Grossman exacted from him the pledge: "... to keep the newsletter a *TECHNICAL / INFORMATIONAL* publication... without BORAX/SCHLOCK advertising of exotic oils, furry toys, gadgets, and stereo loudspeakers!" (emphasis, Dick's).

In April 1985, Jeff was offered a job with Saab in Orange, Connecticut. He turned the editor's job over to Carolanne (so as to avoid a "conflict of interest" as a Saab employee publishing an independent Saab publication) until a new editor/publisher could be found.

By October, Tim Winker, also of Duluth, had been selected as the successor to the Curtis-Delahorne team. As of January 1986, the SAAB Club newsletter, later to be dubbed NINES, was all Tim Winker's. And a fabulous job he has done with it!

Ed Tonat  
Editor, *Smoke Signals*  
Bethesda MD

# SAAB PARTS

AUTHORIZED SALES • SERVICE



**NO SALES TAX • 10% DISCOUNT TO CLUB MEMBERS  
SHIPPING ANYWHERE • KNOWLEDGEABLE PEOPLE  
SAAB FACTORY TRAINED MASTER TECHNICIANS**

**ALL MAJOR CREDIT CARDS ACCEPTED**

**Monte Shelton**  
MOTOR COMPANY

1638 WEST BURNSIDE • PORTLAND, OR • 503/224-3232

ROLLS ROYCE • JAGUAR • SAAB



# SHIFTIN' GEARS

by Jack Ashcraft

## TOW IT RIGHT!

I seem to tow a lot of Saabs these days, particularly Sonetts, and I like to make sure they are still behind me when I get home. A solid hitch on the tow car, a good set of towing lights and a sturdy safety chain are essential, but the heart of the operation is an easy-to-install tow bar mount.

Mine is just wider than the Sonett frame so it slips right up under the car snugly. On Sonett III's, I put the front bolt right through the tie down eyes just below the radiator on the frame. Then I push the mount up into place at the back and block it, then drill three 5/16" holes thru the frame on each side, using the mount as a guide. I put in the bolts, nuts & washers and tighten and that part is done.

I bolt in the tow bar, using 1/2" grade 8 bolts and appropriate spacer washers and snug them down so the tow bar still pivots easily, then double nut them for security. After hooking up the towing lights and the safety chain, it's time to check over the car to be towed.

I disconnect the battery so I can turn on the ignition to unlock the steering. I make sure the car is out of gear and that the emergency brake is off. I jack up each wheel and check for dragging brakes, loose center hub nuts or missing retainer keys. I inspect the tires for previously unseen damage. I also check under the car for anything loose or hanging down, such as exhaust pipes or a broken rear suspension limit strap. I check for anything loose in the engine bay and check the fluid level of the transaxle. Finally, I clean the windshield and rear window inside and out so I can see thru the car when I am towing it.

I tow the car around the block--slowly, and with my window down so I can hear any strange noises--and I listen to it. If this all goes well, I can be off for home with my latest Sonett.

Towing is not a dangerous activity but one that should be given extra care and caution. There are some DOs and DON'Ts to observe, for your towing pleasure:

- DO check your equipment AND the car to be towed very carefully. Be sure the spare is useable.
- DO keep your speed down. Observe towing speed limits.
- DO keep a sharp watch on traffic around you--all the time you are towing. Give yourself a lot more room to maneuver or stop than you would ordinarily.
- DO downshift for hills--for extra power going UP and extra braking coming DOWN. Take it easy.

DON'T use a turbocharged car for a tow car. You can do grave damage to the turbo, the engine or both. Go borrow a Ford pickup or something. Your turbo engine can only stay on boost for a reasonably short time--check your owner's manual.

DON'T get in a hurry. Either when you are getting ready to hook up and go, or on the road. When in doubt, check everything one more time. You will find it is time well spent. GOOD TOWING!

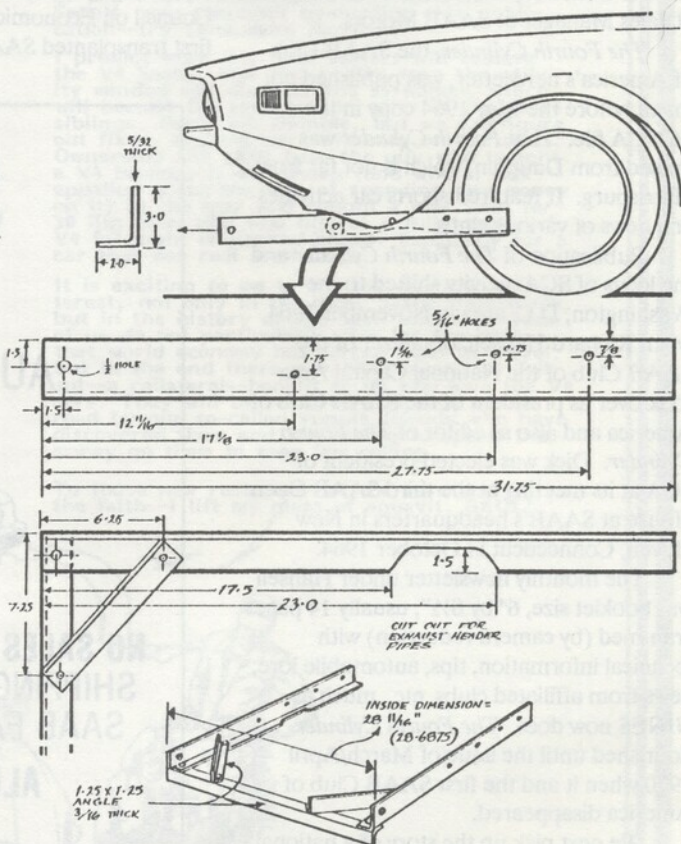

This is a diagram of the mount system that I use for Sonetts. It will work on either Sonett II or III.

This is a diagram of the tow bar that I use. The combination of this tow bar and the mount shown gives plenty of corner turning clearance with no danger of being able to turn too sharp with the tow vehicle so that it would hit either front corner of the Sonett.

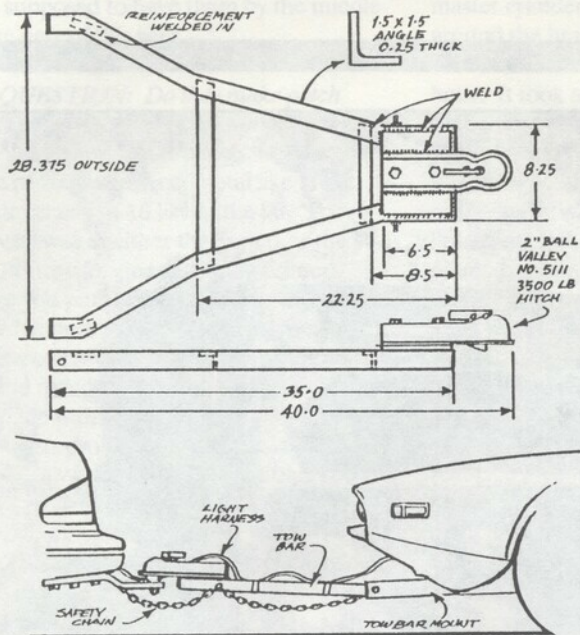

## DROOPY HEADLINERS

Whilst motoring in the 4-eyed Sonett a couple of weeks ago at a fairly rapid rate, three things happened, any one of which could raise my blood pressure considerably above normal. The oil pressure light came on, the radar detector started to screech and the headliner above my pate descended just about to my nose level.

Considerable application of brakes kept disaster away in all three problem areas. Mr Fuzz motored on by with only a glare in my direction, and after stopping, I discovered that the wire on the oil pressure switch had come adrift and was shorting to the frame. THAT was easily repaired. Two down and one to go. The headliner wasn't quite so easy. It clearly had to go.

Last weekend we put not only a new headliner in on 4 eyes, but upholstery and carpets to boot! MY! What a difference. We also decided the time had come to offer some of this stuff to other Sonett owners. Elsewhere in this issue you will find our ad telling you some of the good stuff we have available.

Who knows, a new headliner could be good for YOUR bloodpressure, too!

## YOU-MAKE-'EM TAIL LIGHT TOOLS

Dysfunctioning Sonett (& 99) tail lights are usually corrosion and contact related. Pull the bulb, pull the contact toward you (lights off, please) to restore brass contact tension, using handy wire tool. Swipe a wooden "orange stick" cuticle tool from your wife, glue on a strip of 320 emory, and burnish the contact, the inner end of the socket slots and the pegs on the bulb itself. Presto! Instant light!

## V4 VACUUM GAUGE

I would like to add a comment regarding where to hook up a vacuum gauge on a late V4 engine, as mentioned in Doktor Nio's column (NINES Jan '91): The good Doc suggests hooking the hose to the gauge into the power brake booster hose.

This will work, providing you tap into the hose on the engine side of the ONE-WAY VALVE in the system. The one way valve provides a high vacuum for the power booster and that more or less constant high vacuum is what you would read if you tapped in on the brake booster side of the one-way valve. The engine side of the valve will give you readings on the vacuum gauge representative of what is actually going on in the intake manifold of the engine.

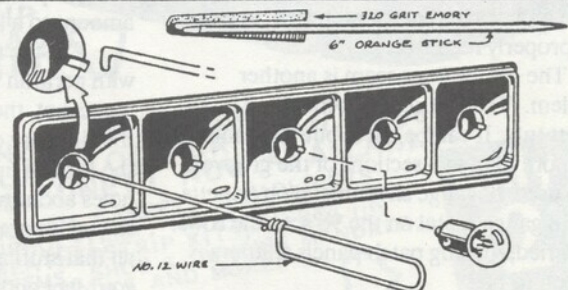
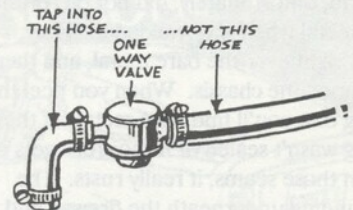
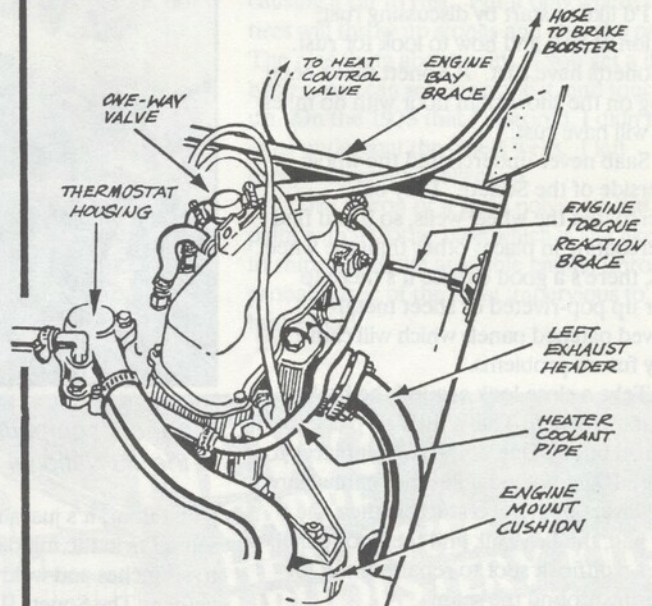

# TECHNICAL TALK

Technical articles written by subscribers may recommend procedures or parts not approved by Saab-Scania of America, Inc. The SAAB Club and NINES cannot stand behind the correctness of information in these articles, but offers them based solely on the experiences of the writers.

## Sonett Restoration

*(Bill Jacobson of Sports Car Service in Wilmington, Delaware, spoke on repairing Sonett chassis at the 1990 National SAAB Owners Convention in Sturbridge, Massachusetts.)*

I'd like to start by discussing rust; location of rust and how to look for rust. All Sonetts have rust. A Sonett that's been sitting on the showroom floor with no miles on it will have rust.

Saab never undercoated the whole underside of the Sonett. They only undercoated the wheel wells, so if you find undercoating in places other than the wheel wells, there's a good chance it's there to cover up pop-riveted or sheet metal-screwed patched panels which will cause many future problems.

Take a close look around the brake lines in the front. That's the first place you'll see rust, but it's one of the easiest places to repair. Right behind it lies the seam where three layers of metal come together; the belly pan, the fire wall, and the floor panel. That's a difficult spot to repair. Look for blistering around the seams.

Saab, unfortunately, did not put primer on the metal when they welded it. They caulked right over the bare metal, and then they primed the chassis. When you peel the caulking out, you'll find bare metal. If the caulking wasn't sealed or if moisture gets between those seams, it really rusts. The seam running underneath the firewall and the seam going over the top of the rear axle are the most difficult to repair and the most time consuming because it's difficult to reach all sides of the box members to clean and properly repair them.

The center floor seam is another problem. The 96 tub is not the same as a Sonett tub. It can be used, but you cannot use more than two sections of the grooves. Saab used 20 gauge sheet metal on Sonetts and 18 gauge metal on the 96's, so the rows are varied, making patch panels a little difficult to fit.

A Sonett trunk floor is the same as a 96

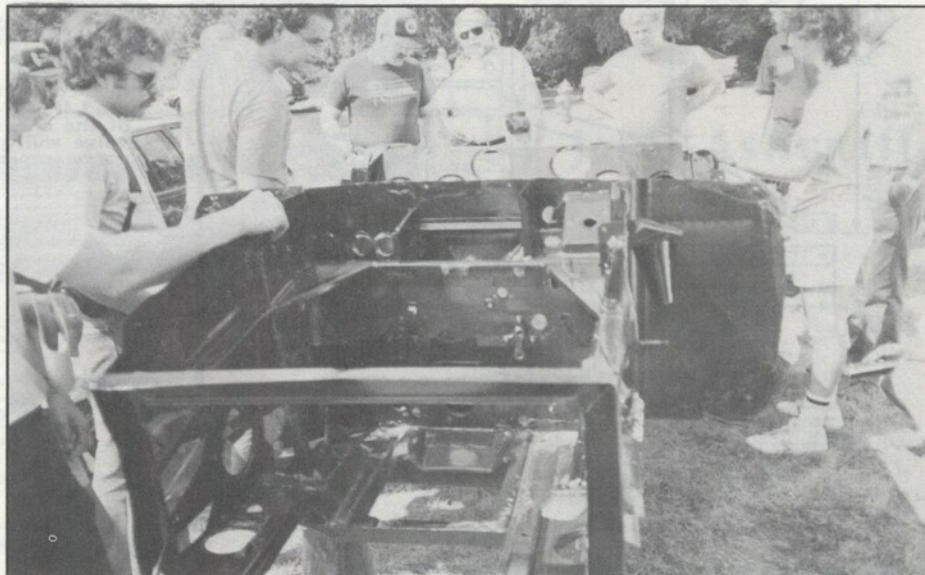

*Bill Jacobson pointed out the areas to watch for rust on a bare Sonett chassis at the '88 National SAAB Owners' Convention in Wilmington, Delaware.*

trunk floor; it's just shortened. A narrow seam sits in the middle. Cut out about four to six inches and weld the floor back together. The Sonett II trunk floor is a shortened version of a 96 trunk floor with the addition of a battery box, so while you can modify 96 chassis pieces to fit a Sonett, it takes a great deal of effort. It looks as if it would be the same, but it's not exactly.

Proper chassis resoration takes approximately 100 hours of labor. If you can find somebody to do it cheaply, that's not bad, but if you have it done at the normal shop rate of about \$40-45 an hour, then proper bottom panel repairs can amount to a lot of money.

Cut the rockers open. They're treated with paraffin wax only. Unfortunately, when it gets hot, the wax runs to the bottom and the sides are completely unprotected. Pull the carpets up on each side and cut long holes about two inches wide. Put on a heavy shirt and some rubber gloves, and clean out all that stuff along side of the seat, up by your feet and behind the rocker. Do the same with the caulking in the center of the

seats where the cars have no primer. The caulk is right on the bare metal. Strip the caulking, prime, and recaulk the car.

Some of the best materials for doing this work are the two-part zinc chromate primers that Dupont and others manufacture. Dupont's numbers are 825 and 825S. It's a catalyzed paint.

Primer may be difficult to buy. Many body shop supply places will not sell it to the public due to hazardous fumes, so you may need to purchase it directly from a body shop. Wear a respirator when using the primer because it is quite nasty and you may feel nauseated when you get done. The next day you might even be sick. It's not good for you, but it's great for the car.

After priming, find a black silicone paint and paint the chassis. Silicone rubber for caulking is good, but because paint doesn't stick to it, the chassis must be painted first, then caulked. That's the way to get the best results in sealing everything. Paint will stick to some of the better automotive latex base caulks, but they don't hold up as well.

**QUESTION:** Does anyone make patch panels for the 96 or Sonett?

Apparently Tabco is going back into the manufacturing of patch panels. They were supposed to have them by the middle or late part of this year.

**QUESTION:** Do they make patch panels for the bottom of the Sonett floorpan?

Yes. They are 96 panels, but they're made of 20 gauge sheet metal like in the Sonett instead of 18 like in the 96. They'll fit pretty well in either the Sonett or the 96.

Prime with zinc chromate primer before you put them on. I restored cars in 1975 that have no rust and are driven every day, even in salt. The only nice thing about the cold rolled steel is that it's what the car was made with and you won't encounter an electrolysis problem. If you use stainless steel or galvanized panels, electrolysis occurs as it would with any mixed metal.

**QUESTION:** Once you restore a Sonett in this manner, would you expect it to last for a long time?

I restored a 1973. Fortunately, I

caught it in 1975 before it had much rust. I raced it for couple of years in autocrosses and it's been used everyday since then. The only place I've had to repair is the area where the hydraulics went out on the brake master cylinder and ate the paint down around the brake master cylinder.

I restored my last Sonett at \$40.00 an hour. It took approximately 30 hours to strip the entire car, de-caulk, de-undercoat, re-caulk, and re-undercoat the car. Now, it's like new. It looks as good as ever, and now it has primer. I found two or three little spots that needed to be plugged, but no major holes. If you have a Sonett that you really want to last, re-caulk before, not after, you have problems.

**QUESTION:** Is there a point at which you deem them unrestorable?

I consider a car unrestorable when the rear axle area needs repair. I repaired one in which I spent I about 25 hours rebuilding the rear axle support member. I had to strengthen the rear axle inner support members because it's mounted at one place in the center. If it rusts under there, you can spend a great deal of time remaking old

96 parts because, unfortunately, you can't buy the pieces.

If it's just slightly rusty and rust is not yet coming up the sides, it's acceptable. You can still strip the body off and repair the rear axle area.

If you have more than an eighth of an inch of rust on that outside where it comes up inside the body, or on the main support where the rear axle is, or if you have excessive rust anywhere, call the car quits. It's just too far gone.

When restoring a Sonett, do not put undercoating on the car. Undercoating is one of the worst things in the world for causing a car to rust. Put it only where the tires will throw up stones and chip the paint. The nice thing about paint, if you get a little blister, you can see it, scrape it, and touch it up. On the 1973 that I restored, I didn't even undercoat the wheel wells. I left everything completely open.

Use Imron or a good polyurethane paint with a Corlar base which is less likely to chip. Of all the available paints, Imron is probably one of the most impervious to brake fluid.

**NEW!**  
**CARPET,**  
**HEADLINER &**  
**UPHOLSTERY KITS**  
**FOR SONETTS!**

**WEATHERSTRIP**  
**KITS FOR SAAB**  
**95/96 & SONETT!**

**NEW! "FINISHING TOUCHES"**  
**CATALOG FOR SAAB 95/96**  
**& SONETT NOW AVAILABLE!**  
 COVERS CARPETS, HEADLINERS,  
 UPHOLSTERY, INST. PANEL PADS,  
 WEATHERSTRIP KITS, DRESS-UP  
 ITEMS, SHOP & OWNER'S MANUALS,  
 NEW BOOKS AND MORE!

**NEW! 95/96 Instrument Panel Covers!**

**4 PARTS**

**JACK ASHCRAFT**  
**AUTOMOTIVE DESIGN**  
 2201 Woodlawn Drive, Medford, OR 97504  
 503-779-0731

**only \$2**

## Tires - Yokohama A008

When my 1987 900 Turbo needed new tires, I decided to replace the Pirelli P6's with a set of Yokohama A008's in the stock size of 195/60-15.

Prior to making the purchase, I tried to become informed by reading every tire comparison test in the automotive magazines, talking to tire dealers who sell performance rubber and by speaking to other car enthusiasts. After several months it became apparent that the 008's were one of the top two or three street tires in the stock size that also enjoyed a good reputation off the race track.

After more than 20,000 miles and two days at Watkins Glen, I can report that the Yokohama is one amazing tire. Compared to the P6, the A008 exhibited better ride, less noise, better cornering, more dry grip, typically more wet grip and dramatically better dry braking. I'll never forget the first time I did heavy braking on the Yokohamas. It felt like the brakes were 50 percent more powerful.

As all tires represent a series of design compromises by the engineers to achieve

the desired performance, I did notice a few tradeoffs. There was a very slight lag in steering response that I eventually adjusted to. It also seemed that the directional tracking was slightly less and I had to pay a bit more attention to steering than before. Because these tires put so much rubber on the road, they will kick up more debris such as the grit and fine stone often found on Pennsylvania country roads.

Obviously, the 008's are not usable in the snow. This was not a problem as I use snow tires in the winter. Standing water and heavy rain at speeds over 70 mph were unsettling, however, traction on wet pavement in general was very good and superior to the P6.

High grip also means less treadlife. Plan on 20,000-30,000 miles depending upon usage, inflation pressures and alignment.

Overall, this tire offers just about the most performance you can buy for your SAAB short of a race or track compound. The wet weather tradeoff is handled by the SAAB's inherent traction. Most other performance sedans, like BMWs, would not even be able to run this tire on the street. Four snow tires are a must, but you should have separate snows anyway.

On the track, the 008's were very well behaved. They exhibited high levels of competence with good feel. When cornering at the limits of adhesion they would "talk" to let you know exactly what was happening. As a novice, the Yokohama was more tire than I was driver and it certainly handled everything I could dish out. If you examined the amount of solid rubber on the outside shoulder of the tread, you can see the tire was designed to handle high cornering forces without chunking.

Is this the performance tire for you? Well, it has its priorities and I could understand someone opting for a tire with better wet weather capabilities. But if you want high performance rubber, or live in an area of less precipitation, or plan on spending some time on the track, the Yokohama A008 is one very impressive tire.  
Mark Uhryk  
Dillsburg, PA

## Re: 1988 Saab 9000S

Generally, with nearly 30,000 miles on the car, we've had no major problems with our 1988 SAAB 9000S. The underpowered motor is the only flaw. And, overall, the car is superior to the 900...but, sure miss the turbo!

I've learned to leave the Automatic Climate Control alone...it does a great job mainly in extreme temps.

I've significantly improved handling and control by mating SAAB's Super Inca 6"x15" wheels with the new Pirelli P-500 all-season performance tires (195/60 R15). So far, the Pirellis are fantastic on wet and dry surfaces... still waiting for snow conditions.

Owners of 9000's can replace their OE batteries with Delco Freedom Dura Power 60's (26R-60S)...no special order...and fits with room to spare.

Jim Greg  
Pittsburgh, PA

## Simple alarm warning light

I have come up with a solution for a problem faced by many SAAB owners -- break-ins. Even the SAAB-guard alarm system usually does not have an LED to ward off potential thieves. My '84 900 Turbo is no different. Here's what I did:

First, choose an LED location - I put mine in the speaker/defroster plate on the dashboard. Radio Shack sells red LEDs that flash, but because they operate on 5 volts, you will need a 1/2 watt, 1K ohm resistor, plus a pack of LED snap-in holders. Once they are installed, they need power.

Find a full-time power source such as the headlights or the one that feeds the radio. Now, you need something that turns off when you turn the key on (so you don't have to drive around with these lights going) - the answer is the interior light (as long as you have the 15 second delay). The relay is under the rear seat, the one with only 4 wires going to it. Use the white wire as your ground. Alternatively, you could use a switch on the dash to control the lights, but this is a hassle. Here are the part numbers:

Blinking red LEDs 276-036  
LED holders (pack of 5) 276-079  
1/2 watt 1K ohm resistors 271-023

There is no need to have an alarm to equip your car as instructed above. You could install the LED and pretend you have an alarm. Could a thief tell the difference?

Lewis Eig  
Monsey, NY

### Specialty Car Care Products

#### ZYMÖL

ZYMÖL is a non-abrasive car care system, using all natural ingredients.

Cream Wax (For Light colors)	8oz.	\$35.00
Carbon Wax (For Dark colors)	8oz.	\$35.00
Saab Wax (For all Saabs)	8oz.	\$35.00
Japan Wax (Cars manufactured in Japan)	8oz.	\$35.00
H-D Cleanse (Use before Wax)	8oz.	\$15.00
Brite (wheel cleaner)	8oz.	\$15.00
Strike (Removes oil & grease)	8oz.	\$20.00
Treat (leather conditioner & treatment)	8oz.	\$15.00
Vinyl (Vinyl & Rubber trim)	8oz.	\$15.00
Clear (car wash)	8oz.	\$15.00

ZYMÖL Starter Kit - includes wax (specify), 8 oz. H-D Cleanse, 8 oz. Clear, Car Care Booklet, Towel, Applicator, Window Decal, Jacket Patch. \$75.00

ZYMÖL Complete Kit - A custom designed, hinged ABS trunk carry-all with a Polyurethane dye cut foam insert for organization of Zymöl products. Wax, H-D Cleanse, Brite, Clear, Applicator, Towel, Wheel & Detail Brushes, Spray Bottle, Treat, Vinyl, & Detail Wax. \$200.00

1-800-245-2546 USA & Canada  
24-hour answering machine

### Specialty Car Care Products

786 Baylor Road  
Rochester Hills, MI 48309-2511  
Visa & MC



## Talkin' Turbos

(Nat Wentworth spoke on the care and feeding of turbochargers at the 1990 National SAAB Owners' Convention in Sturbridge, Massachusetts. Nat is owner of Eriksson Industries in Old Saybrook, Connecticut. Eriksson Industries rebuilds cylinder heads, transmissions, engines, and turbochargers for Saabs and for some other cars. They sell wholesale to independent repair shops, not to the general public.)

I want to talk about turbocharger failure and repair. Hopefully, when we're finished, you'll understand how to get 100,000 miles or more out of your turbocharger before you need to replace it.

A turbocharger is an exhaust driven supercharger which can, in theory, more than double the horsepower of your engine. Exhaust gas enters the turbine housing and spins the turbine wheel. This in turn spins the compressor wheel, which is connected to the other end of the turbine wheel by a shaft. As the compressor wheel spins, air is forced into the intake side of the engine, increasing manifold pressure. The theory is if pressure increase doubles atmospheric pressure, the horsepower of the engine is doubled. There are in practice limitations to the amount of boost you can obtain, the main obstacle being detonation.

Most failures of turbos start at the turbine side (hot or exhaust side) of the turbo. As the bearing on the turbine side wears, the seal is damaged causing oil leaks which result in excessive engine smoke. At full boost the turbocharger wheels spin at about 100,000 rpm's (almost 1,700 revs per second!). The bearings for the turbo are basically solid bronze parts that have about one-half thousandth clearance to the turbine shaft and approximately three-thousandths clearance to the bearing housing. These "free floating" bearings run at half the speed of the turbine wheel. The slight cushion of oil on both sides of the bearing also absorbs some vibrations in the shaft, thereby extending the life of the turbo.

There are two types of seals used in turbos -- dynamic (piston ring type) and carbon face. Saabs only use the dynamic type of seal. The ring fits in a groove on the turbine shaft and sits tightly against the bearing housing. There is a clearance between the ring and groove, but in order for oil to leak around the seal, it must move in toward the center of the spinning shaft.

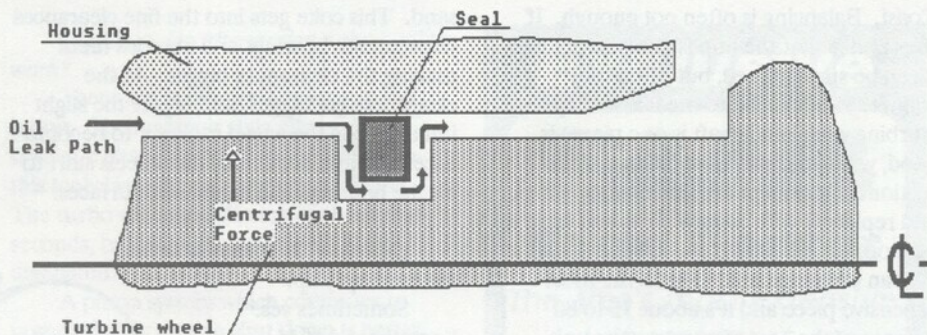

Centrifugal force and a piston-ring type seal keep oil from leaking into the exhaust.

Since centrifugal force is trying to throw the oil away from the centerline the oil cannot get past the seal (see diagram above).

The main cause of turbo failure is "coking" of the oil. Oil will burn at about 300 degrees F. and the temperature inside the turbo can get to 1600 degrees. When oil burns, it leaves a solid "coke" deposit. This deposit is very abrasive and causes wear in the bearings. When the wear gets bad enough, the turbine wheel contacts the seal ring and bearing housing causing damage. When the seal is damaged, oil can leak into the exhaust system where it is burned and shows up as smoking exhaust.

The best way to make your turbo last longer is to keep the oil from getting too hot. Water-cooling helps, but even with water cooling it is important to let the engine idle for a minimum of 30 seconds after normal running and longer after hard use. This period of idling lets the turbine wheel slow down, and lets the oil carry away the heat. If the temperature is reduced below the coking temperature by flowing oil then no coking will occur. If coking can be eliminated the turbo will last well over 100,000 miles with or without water cooling. Obviously, without water cooling the amount of time that the turbo should be idled (cooled) will be increased. Use 30 seconds as a minimum for normal driving.

Rebuilding a turbo involves checking of the turbine shaft for straightness and balance, inspecting the bearing housing for size and cleanliness, re-sizing the bearing journals, and replacing seals, bearings and gaskets. The turbine shaft is the real key item since it is so expensive. If the turbine shaft is okay then all other parts of the cartridge can be replaced economically. If not, then an exchange unit should be purchased.

I do not recommend turbo rebuild kits

unless a new center bearing housing is used. Even then it is important to be sure that the turbine wheel is in acceptable condition. The turbo is a very simple component, but since it operates at such high speeds, surface finishes, alignments and balance of the components are critical to long life. The ability to make the necessary measurements is beyond most people's capabilities.

*QUESTION: Is there anything particularly good for cleaning the compartment on the center section?*

No. We've tried baking them in ovens, but the only thing that I've found that works is to heat them up with a torch until the oil stops burning, and then clean the inside, but you need to be very careful. You need to have mirrors and little optic devices so you can see into all corners and make sure all the coked oil is out. The other option is to buy a new center housing.

If you suspect you have a turbo problem, reach inside, grab the compressor wheel, and see how much play it has. A brand new wheel will have some play in it. If you grab the end of it on the intake side, push it up as far as you can, and try to turn it, it should turn very freely. If you feel drag, then your turbo has rubbed or is rubbing against the outside housing, and you've got a problem. Anytime the wheels make contact with either housing, material is being taken off, so it's critical that you have them rebalanced. They are balanced to micro-ounce inches, and if they're not balanced the bearings will be damaged and you'll be rebuilding in another five or ten thousand miles.

*QUESTION: What's involved in balancing them?*

You need a special machine that costs about \$13,000. I send them out to the West

Coast. Balancing is often not enough. If they notice that the hub is bent, sometimes it can be straightened, but often they cannot. If this turbine wheel assembly (turbine wheel and shaft is one piece) is good, you can throw away all the center section stuff, except for the main housings, and replace it with all new parts and have an economical rebuild. If this is shot, forget it. Buy an exchange unit. This is the most expensive piece and it's about 75 to 80 percent of the cost of an exchange unit. Why go through all that trouble when you can buy an exchange unit that's guaranteed.

The 1978-1880 Saabs have a smaller turbine wheel than the 1981 and up. Theoretically, smaller turbine wheels spin more easily causing quicker response, and for some reason they will run and run and run. You can drive until they're worn out and still get boost out of them until they completely break. The later ones will start to rub, and it will take a little bit more to get them up to speed. You start getting significant oil problems long before they get to this stage. The thing that causes this problem in the first place is coking of the oil. When the oil gets very hot, it leaves an abrasive coke deposit. It's like throwing in

sand. This coke gets into the fine clearances between the bearings and abrades them making the clearances bigger. As the clearances get bigger, and bigger the slight imbalance in the wheel causes it to become eccentric, and eventually the wheels start to hit the housings and or the seal surfaces.

*Question: Is it normal to hear the turbo spin up?*

Sometimes yes.

Sometimes no. If

it's properly balanced and all the parts are good, you should not hear

it spin up. New turbochargers from the factory sometimes make a noise that sounds a little bit like a siren. That's acceptable. If your turbo is quiet for most of its life and all of a sudden you're hearing noises, then, chances are, it's rubbing and going out of balance, and it will get louder and louder as you go along.

*Question: Will an out of balance turbine cause low boost?*

I wouldn't think so.

On the Saab, the turbo charger mounts like this on the car. As boost builds up, it picks up manifold pressure from the compressor side, and goes into this little diaphragm. This is spring loaded to pull this lever closed, and as the air pressure builds up, the pressure pushes the diaphragm or this rod in that direction and allows exhaust to bypass around the turbo so that the turbine doesn't spin any faster. There's a little flat valve in here. The lever closes down against the exhaust. The exhaust goes into the turbine housing, through the turbine wheel, and is supposed to come out the center, but there's a little hole right here that works as a bypass. When the diaphragm spring loads it closed, all the exhaust must go through the turbo and come out the center. When the waste gate tells it that there's too much pressure, the waste gate opens and the exhaust bypasses the turbine wheel.

If you want to increase boost, you must shorten the rod. You're working against a spring that's pushing the rod out, so the more you compress the spring, the more

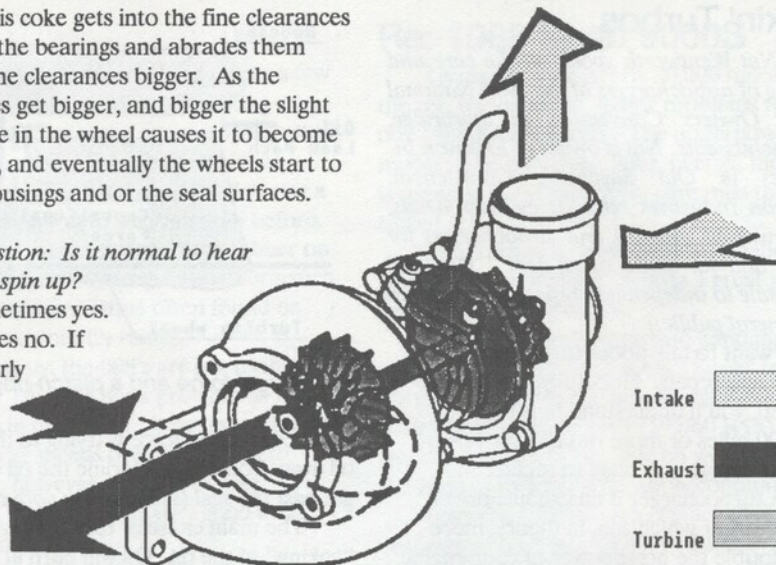

boost you will get.

Two things I'll say as a word of caution. First, if you have an APC system, you're going to be limited by detonation unless you're running very good gasoline, or water or alcohol injection. As soon as the engine starts to detect detonation, it will send a signal to open the waste gate. If you set the boost too high, the APC system won't send enough pressure to open the waste gate when it should, and your engine could possibly be damaged. On a non-APC equipped car, again, the same thing. You can set the boost tight.

I know a guy with a 16-valve turbo who set the boost around 20 pounds, but he's running in racing situations. He can travel around Lime Rock (racetrack) for about 45 minutes and then he cleans all the teeth off of fourth gear going down the main straight. Saab transmissions won't stand up to that amount of torque.

There are two ways that the waste gate will cause problems. Either it doesn't open or it stays open all the time.

The boost that a turbocharger puts out is proportional to the square of the velocity. In other words, if the velocity increases two times, you get four times as much pressure, so as speed goes up, the boost goes up very quickly. Once you get into the red, the boost pressure needle will swing right over, so you need to be very careful about setting boost. Most cars will have a fail-safe switch that will cut out the fuel pump when you get to a certain boost.

1978-80 cars had the exhaust driven waste gates. There was a diaphragm on top

**SPECIALTY PARTS FOR YOUR SAAB**  
Enhancing Performance, Appearance and Comfort



SEND FOR FREE CATALOG  
Replacement Parts and Unique Accessories

(former Saab Dept of ipd)

**SAS**

Swedish Auto Specialties  
2820 N.E. Broadway  
Portland, OR 97232  
(503) 287-5204

of the waste gate and the car exhaust gas went against it. They had problems burning those out, keeping the waste gate closed all the time. If the waste gate is closed all the time, you'll step on the gas and all of a sudden as you pull out into traffic, the boost will come flying up, the fuel pump will shut off and your face will go against the windshield. When you let off the gas, the fuel pump comes back on again. If the waste gate is stuck open, you won't get any boost at all.

*Question: Does it make any sense to replace a '78 turbo with one from an 81-84, to get the benefit if the newer style waste gate?*

Not really. The diaphragm costs only about \$35.00 and is simple to replace. By the time you made all the modifications for the newer style waste gate, you would have to include a new turbo. It isn't worth the expense.

*Question: I have tried to adjust the wastegate, but the boost level doesn't change.*

I suspect you have a loose clamp on either the outlet hose or one of the other fittings. It's acting as its own wastegate.

*Question: Do aftermarket turbo coolers work?*

There are two types -- reservoir and pump. The reservoir style allows oil to continue to trickle down to the turbo, but this only lasts for a short period of time. The turbo will stop spinning in about five seconds, but all of the heat won't have dissipated.

A pump system which continues to pump oil after engine shut down is better because you can set them to operate for up to three minutes.

A pump system that operates before you start the engine is even better. The shaft runs on a thin film of oil. If the oil pressure is up and there is oil flowing across the shaft before it starts to spin, there is less wear on the turbo, and on all engine components for that matter.

*Question: Will synthetic oil help?*

Yes, because it can withstand higher temperatures. It doesn't coke until 800 to 900 degrees, but you must realize that the temperature in the housing is far above that, so cool down is still necessary.

**Exclusive**  
**SAAB**  
**Parts Center**  
*The area's most extensive inventory at competitive discounts*  
**(215) 886-8660**  
 Free delivery locally or Standard UPS  
**SAAB** →  
 ← **VICTOR**  
**Exclusively SAAB since 1958**  
 1125-35 Easton Road • Abington, PA 19001  
 Facsimile (215) 572-5030



**GOLDWING**  
**USED SAAB PARTS WAREHOUSE**  
 Nationwide Shipping UPS - COD

- Alternators
- Starters
- Axles
- Calipers
- Antennas
- Radios
- Wheels
- Tires
- Tail Lights
- Window Motors
- Rack-n-Pinions



- Transmissions
- Engines
- Radiators
- Grills
- Fenders
- Turbos
- Bumpers
- Air Compressors
- Cyl. Hds.
- Seats

**All parts Tested and Guaranteed, some Lifetime!**  
**Over 75,000 Used Parts In Stock**  
**We Specialize in 900 and 9000 Only**  
**Call 1-800-SAAB137 or (315) 625-7969**  
**Rt. 11 Hastings NY 13076**

## EFI cold idle surging

I have an inexpensive alternate repair for the typical early electronic fuel injection [99s thru 1974 with EFI] cold idle surging that may not require the replacement of the auxiliary air valve. It has been my experience that valves fail in a manner of opening too much when cold, but still being able to close when hot.

An easy and obvious repair would be to limit the overall amount of air the valve is allowed to pass. This can be done by installing a short piece of dowel with a hole

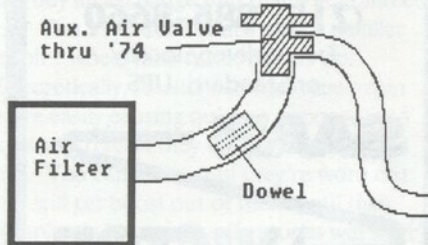

drilled through the center in the intake hose for the auxiliary air valve.

The size of the hole would depend on the particular car, and is easy to experiment with.

Herb Gallagher  
Waltham MA

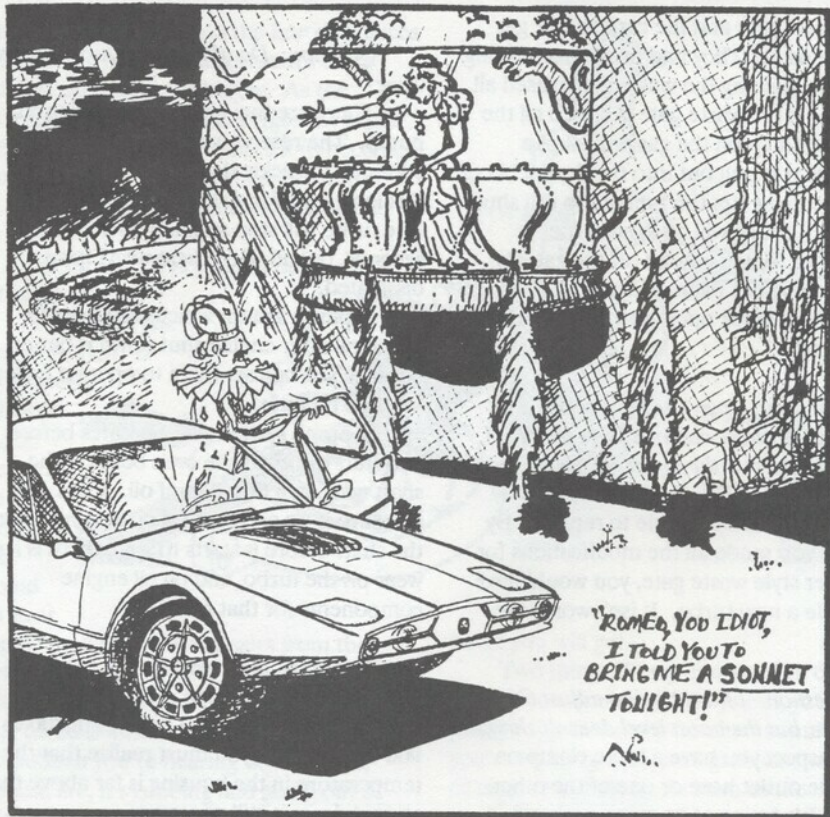

Paul Carpentier  
From SAAB Sport, Milwaukee SAAB Club

Orders Only \$25.00 Minimum 1-800-999-1820 MC/Visa/Amex		<b>IMPORT MOTOR PARTS</b> 110 WEST 12TH ST., PUEBLO, CO 81003 ** Same Day Shipping **		Information & Technical Help 1-719-542-7025	
<b>BOSCH ALTERNATORS (EXCHANGED)</b>		<b>BOSCH WARMUP REGULATORS</b>		<b>RADIATORS &amp; WATER PUMPS</b>	
AL35X	78-83 Turbo & 81-83 900s 162.25	40013	1975 99 All 134.94	7540503	Radiator 1977-80 99s 175.00
AL36X	5/78-80 99 Non Turbo 147.35	40020	76-80 99,900 Non Tbo 85.86	7541063	Radiator 79on 900s 179.95
AL69X	85-86 900T, 86 9000 Turbo 204.95	40032	76-80 99,900 Calif cars 106.22	7541071	Radiator 79on 900 Tbo 169.95
AL95X	67-74 95, 96, Sonett 68.15	40051	78-80 All Tbos. 106.22	8358491	Pump 75-76 99 12 Cog 69.95
AL96X	74-4/78 99 102.25	40084	81-83 900 & Tbos. 179.95	8367674	Pump 77-80 99,900 (Kit) 79.95
AL112X	79-80 900 Non Turbo 103.35	40136	84-86 900 & Tbos. 110.82	8389058	Pump 69-76 99 (Kit) 32.95
AL128X	84-85 900 Non Turbo 186.95	<b>BOSCH FILTERS</b>		8389751	Radiator 69-76 99s 189.95
<b>BOSCH FUEL PUMPS</b>		05005	Fuel 75-77 99 14.57	8814591	Pump 67-74 95, 96, Sonett 29.95
GFP202	82-86 900, 82-84 Turbo 225.06	05021	Fuel 78-79 99,900 & Tbos 10.96	8817819	Radiator 78-80 99 Tbo 189.95
GFP213	75-81 99,900, & Turbo 169.95	05401	Fuel 80-4/85 900, Turbo 15.12	8817900	Pump 81-88 900 8 Valves 36.95
GFP270	69-74 99E, 99 EMS 135.86	05601	Fuel 5/85-86 900, 16V, & Tbo 16.58	9382649	Radiator 86on 9000 5sp 297.00
GFP288	1985 900 Turbo 16V 143.88	72101	Oil 67-88 Saab All 3.71	<b>MUFFLERS</b>	
GFP294	86 900 16V, 9000 Turbo 167.04	73228	Air 75-86 2.0 exc 16V 5.50	7282007	67-73 95, 96 V4s Front 39.95
<b>BOSCH STARTERS (EXCHANGED)</b>		<b>BOSCH IGNITION PARTS</b>		7533631	69-88 All 8V NonT Rear 39.90
SR32X	85-87 900, 9000 & Turbos 214.45	00044	12 Volt Universal 14.23	8838005	67-73 95, 96 V4s Rear 31.39
SR77X	70-74 99 86.30	03010	Dist Cap - Most Saabs 5.18	9326463	81-83 900 Turbos Rear 63.35
SR78X	75-84 99,900 & Turbos 93.45	04038	Rotor 78-80 99,900 Tbo. 4.55	9349143	86on 900 NonT 16V Center 69.50
SR79X	69-73 95, 96 & 71-74 Sonett 83.55	04125	Rotor 1981 900, Turbo 6.27	9349176	1986 900 Rear 65.95
SR80X	67-68 95, 96 & 68-70 Sonett 87.95	04144	Rotor 82-85 900T; 82-87 900 9.52	9349192	84on 900 Turbos Rear 82.89
<b>IGNITION CONTROL UNITS</b>		04168	Rotor 1985 900 7.80	9361817	1979 900 exc CA Front 49.99
00014	99,900 78-81 232.13	09105	Wires 72-80 All 99s, 900s 12.95	9365511	78-80 99 Turbo Rear 63.98
00139	900 82-84 109.01	09106	Wires 81-87 900, 900 Turbos 12.95	<b>POWER STEERING RACKS</b>	
<b>BOSCH LAMBDA SENSORS</b>		<b>BOSCH MISCELLANEOUS ITEMS</b>		26 980	79 & on 900s (Short) 179.95
01051	77-86 1 Wire 38.95	Non Resistor Spark Plugs 1.32	Resistor Super Spark Plugs 1.50	26 1980	79 & on 900s (Long Rack) 229.95
03006	86 900 16V 112.46	Platinum Resistor Spark Plugs 2.48	MicroEdgell Wiper Blade 10"-16" 4.84	<b>REPCO METALMASTER PADS</b>	
03009	84-4/85 900 Turbo 16V 134.33	MicroEdgell Wiper Blade 17"-20" 6.19	MicroEdgell Refills 4.78	111M	76 & on 99,900s (Rear) 21.95
03028	5/85-on All Turbo 16V 144.07	<b>TIMING BELTS &amp; PIECES</b>		226M	99,900 Front Brake Pads 21.95
<b>BOSCH IDLE SPEED REGULATORS</b>		7500697	Chain 85on 16Vs 28.69	<b>KYB GAS-A-JUST SHOCKS</b>	
40502	85-86 16V 134.94	7871403	Chain 73-80 99,900 29.75	Lifetime Warranty for most Import and American cars including Saab 21.95 ea	
<b>BOSCH FUEL INJECTORS</b>		8346785	Crank Gear 73-80 99,900 37.95	<b>KONI SHOCKS</b>	
50045	71-74 99 All 1.7, 2.0 35.62	8346793	Idle Gear 73-80 99,900 34.95	Adjustable Shock (most Saabs) 58.95 ea	
02004	75-80 99,900 Exc 78 99T 20.81	8346801	Cam Gear 73-80 99,900 41.25	<b>BILSTEIN SHOCKS</b>	
02012	81-86 900 All 8 Valve 22.50	8347874	Tensioner 73-80 99,900 26.65	HD Setting for 900 8 valves 66.85 ea	
<b>BOSCH COLD START VALVES</b>		8817405	Tensioner 81-88 900 8V 19.98	<b>MISCELLANEOUS ITEMS</b>	
70401	75-80 All 35.94	9359779	Chain 81-88 900 8V 19.98	0260257	Wind Deflector 900s 47.50
70406	81-86 All 8 Valve 42.69	<b>COUNTERSHAFT</b>		8307498	Clutch Disc 99,900 4sp NT 34.95
<b>CONSTANT VELOCITY JOINTS</b>		8358509	73-80 99; 79-80 900 2.0 225.00	8704116	Clutch Cover 99,900 NonT 39.95
8921728	75-80 99,900 Outer Jnt 137.95				
8942633	81-85 900 Outer Joint 137.95				
8945735	69-84 All Inner Tripod 49.95				

## Tim Brown's Tech Barn

### 9000 Tips

**Rear brake pads** -- Check your right rear brake pads regularly because the emergency brake cable can be stretched tighter when carrying heavy loads in the rear, causing the right side rear brakes to wear faster than the left. The solution is to remove the right rear emergency brake cable from the holder on the trailing arm and re-attach with a tie-wrap in a straighter line to the brake caliper.

**Front exhaust pipe** -- If you have developed an exhaust leak at your flex pipe (part of the head pipe in the original equipment exhaust system), the entire head pipe need not be replaced. Ask your Saab technician about the flex pipe repair part that replaces just the latter half of the head pipe at the failed section, a much less expensive repair than an entire head pipe replacement.

**Blown fuses** -- Does the fuse for your power sunroof, rear windows and back-up lights keep blowing in your 1990 or 1991 9000? There has been a problem with the one-piece switch assembly that controls the windows and sunroof, in that it can develop a short circuit that continually blows fuse #9. These assemblies were on national back order, but should now be available through your Saab dealer under warranty.

### 900 Tips

Squeaks from the rear seat area of a four-door 900 could be caused by the support rod of the parcel shelf. The forward edge of the shelf is supported by a round aluminum rod which is clipped and insulated on both ends. Quite often the insulation, a rubber sleeve, works its way off on one end or both ends. If you can't find the rubber sleeve and replace it on the rod, use a couple wraps of electrical tape and make sure the clips are in place so your repair remains that way.

**Dim Taillights** -- Older four-door 900 rear light assemblies are subject to poor ground connections that manifest themselves as dim lights from the rear, especially when using multiple functions of the assemblies (i.e. parking lights, turn signals and brake lights together). Also, if you have this problem, you may see the turn signal indicators on your dash light dimly when you

use your brakes.

The solution to this problem is to run new ground wires from the taillight assemblies to the trunk grounding point. Start by removing the cover panel and connectors for the rear light assemblies. The assemblies then pull out inward by releasing the two catches on the inner and outer edge. You then trace the common ground for all the lights and find a square metal pad in that ground circuit to which you can attach and auxiliary ground wire. You then clean and tin the ground pad with a soldering iron and solder a three-foot piece of 16-gauge wire to it. Then use the soldering gun to make a hold large enough to run the wire through the plastic of the assemblies and feed the wire through. Proceed to re-install the assemblies.

Bring the auxiliary ground wires together with a ring terminal and attach to the trunk ground point at the rear center body beam screw.

Remember to clean the connectors when you have them apart and check the lights when you're done.

**Fuel Smell** -- If your interior seems to smell of gasoline, the likely culprits are the vapor return line connection at the roll-over valve, or the connections to the fuel neck. To find the roll-over valve, remove the trunk carpet on the right rear and follow the hose from the top of the fuel neck to the valve mounted about a foot above the trunk floor on the hidden outer side of the trunk wall. At the top of this valve, a plastic vapor line, similar to a fuel line, should fit snugly into a rubber junction piece. If this doesn't seem to be the problem, check all the connections to the fuel neck assembly. Close inspection may reveal a cracked fitting. If one is broken, sometimes you can fix the break or reattach the outlet with structural adhesive or epoxy. If all else fails, you will need to replace the fuel neck assembly with either a new or good used part.

**Stereo Upgrade** -- In a three-door, when installing upgraded speakers, try the rear seat panels just above the arm rests instead of the existing locations. The position fits either a 5¼ inch round or a plate speaker with flush mount tweeter. The stock speaker wires also reach easily.

Tim Brown, Technician  
Parrformance, Lititz PA  
from *Central Penn SAAB Club Newsletter*

## CAMPBELL/NELSON Auto Wrecking



# SAAB

### USED PARTS CENTER

205th & Aurora, P.O. Box 220  
Edmonds, WA 98020

1-206-771-4931

1-800-552-2999

(Out of State)

## BOB YATES IMPORT CAR SPECIALISTS

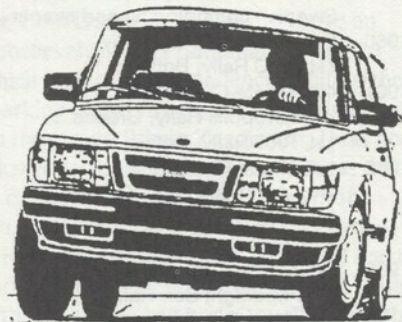

TOLL-FREE PARTS LINE  
1-800-669-SAAB

Fax# 215/752-5614

Discount to SAAB Club members

Rt. 1 & I-95  
Langhorne, PA 19047

## ERIK CARLSSON - SAAB's Rally Ace

Erik Carlsson was born in Trollhattan on 5th March 1929. His first real contact with motoring as a sport was as a 16 year-old youngster in motocross and TT (Time Trial) events on heavy motorcycles.

Erik made his rally debut in 1952 as co-driver in the Midnight Sun Rally. The car was driven by the owner of the service station where Erik was employed, Pelle Nystrom. In the autumn of 1954, he began his career with Saab in a local rally outside Trollhattan. Erik surprised both the experts and the opposition by winning his class with a Saab 92.

In 1957 Erik became a full-time test-driver for the Saab Factory in Trollhattan and number one driver for the then fledgling Saab motorsports team. National and international victories have followed one after another and Erik soon became not only the best known Swedish rally driver,

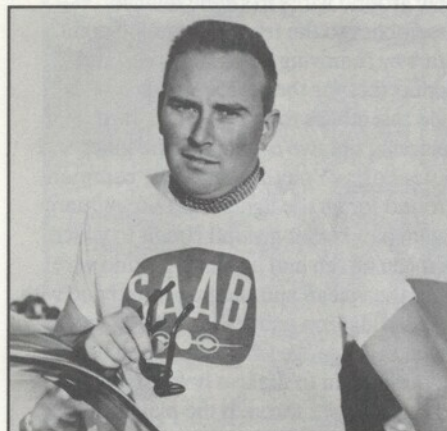

but also one of the first international "names" in rallying.

Much of his success comes from his determination and fitness. During military service he took part in many athletic events and earned the title "Sweden's best soldier".

He does not seem to know the meaning of "competition nerves" and he has the happy knack of being able to relax whenever necessary. He also seems to be able to do without sleep (or very little sleep) - an important ability for a rally-driver, which may also have contributed much to Erik's success.

Erik Carlsson has been given many nicknames during his rally career: "Carlsson-on-the-roof" (or "Carlsson På Taket"), "Carlsson the Conqueror", "Giant Swede", etc. He got his most well-known

sobriquet of "Carlsson-on-the-roof" many years ago when after a couple of dramatic rolls, he ended up with the wheels in the air.

In 1953 he married Pat Moss, another big name in the world of motor sport and sister of race driver Stirling Moss. They now live in Tring, a village roughly 50km north-west of London together with their daughter Susan, born in 1969.

Susie has followed her mother's early career in championship show-jumping, and much of Erik's spare time is devoted to helping out in the stables and keeping the Scania combined mobile-home and horse-box in good order.

However, since the early 1970's Erik has been a member of Saab's Public Relations Staff. Apart from acting as Saab's roving ambassador travelling nearly 200 days a year all over the world to be present at major Saab events, he is also a mainstay at Saab's test-driving programmes for the press. To his many nicknames, he can now add "Mr. Saab".

His achievements as a PR-man for Saab were recognized in 1979 when the British Guild of Motoring Writers named Erik as Public Relations Man of the Year in Britain and elected Friend of the Guild.

Anyone who has sat next to Erik for a few laps around an ice-circuit, on a race track, or a closed rally stage in the forest, can witness that Erik's greatest passion is still sitting behind the wheel and making the car obey his every command - whatever the speed. Fun for Erik and a thrilling experience for the passengers.

### Here are some of Erik Carlsson's more important placings:

- 1955 1st. National Cup
- 1957 1st. Rally of the Thousand Lakes, Finland
- 1958 Swedish champion on ice, up to 1,000 cc
- 1959 Swedish champion on ice, up to 1,000 cc
- 1st. Midnight Sun Rally
- 2nd. Adriatic Rally
- 1st. German Rally
- Swedish champion, speed events
- 1960 Class winner, Tulip Rally
- 1st. RAC Rally, Britain
- 1961 4th. Monte-Carlo Rally
- 1st. Acropolis Rally, Greece
- 1st. RAC Rally, Britain
- 1962 1st. Monte-Carlo Rally
- 2nd. Acropolis Rally, Greece
- 1st. RAC Rally, Britain
- 2nd. Geneva Rally
- 1963 1st. Monte-Carlo Rally
- 2nd. Midnight Sun Rally
- 2nd. Spa-Sofia-Liege Rally
- 3rd. RAC Rally, Britain
- 1964 3rd. Monte-Carlo Rally
- 1st. Rally de Fiori
- 2nd. Coupe des Alpes
- 2nd. Polish Rally
- 2nd. Spa-Sofia-Liege Rally
- 2nd. Safari Rally, Africa
- 1965 2nd. Acropolis Rally, Greece
- 3rd. Polish Rally
- 4th. RAC Rally, Britain
- 1967 1st. Vitava Rally, Czechoslovakia
- 1969 3rd. Baja 1000, Mexico
- 1970 5th. Baja 1000, Mexico



Erik on the way to his second Monte Carlo victory, in 1963.



*The adventures of Erik Carlsson since 1959 as related by Erik himself:*

The first Saab - the Saab 92 - was actually quite similar to the Saab 96, if we disregard the horsepower under the bonnet. The small 764 cc two-stroke originally developed all of 25 horsepower. Prior to races, we tuned the engine in various ways, but all we have ever managed to get out of it is 48 horses. A handy way of getting a few more horsepower out of the engine was to provide an extra hole in the front silencer. The hole was blanked off with a radiator cap for the inspection before the race. We then took the cover off, and this expedient gave an extra 5-6 horses. But the exhaust gases were obviously discharged into one of the front wings.

One of the veteran mechanics is Bernt "Malin" Melin who came to Mexico in 1967-70 when I raced in the "Baja 1000". Malin has been in the business since the tender age of 14 years. He was then "moonlighting" at the same petrol station as myself. We eventually succumbed to his constant nagging and took him with us as mechanic on one of our rallies. Things weren't all that well organized in the 1950's - we had no special service trucks at our disposal, and had to leave Malin under a pine tree out in the woods about midday on the Saturday when the race was to be run. He sat there alone on a couple of sacks and waited. All he had with him was a packet of sandwiches and a couple jerrycans of petrol. When we passed on Saturday night, we got our petrol and carried on. We picked Malin

up after the prize-giving ceremony on Sunday morning...

The old two-strokes didn't hold the road as well as the cars of today, and to improve them a little, we always tried to bend the rear axle so that the rear wheels would slope inwards at the top: This is known as negative camber. To achieve this, we filled the back seat with a crowd of youngsters and drove up a high mountain, along a road with many nasty potholes. After a few hefty bumps at 60mph, the axle was bent at just the right angle.

The old three speed gearbox of the 92 was unbelievable strong. The gear lever were exactly the same as on the American three-speed cars with the steering column gear-shift lever, and this often caused problems in races. A slight slip of the hand when changing in a hurry down from top to second and you'd engage reverse instead of second. When you then put your foot down, two solid jets of gravel and mud would shoot forward instead of to the rear. Talk about strength...

The ignition point on the tuned two-stroke was incredibly close to TDC. The consequences were sometimes shattering. When revving the engine at traffic lights, for instance, and engaging bottom gear, the car would sometimes start reversing. The directional rotation of the engine had simply reversed!

When we ran the first test on the new three-cylinder two-stroke, we had to make sure that the engine would stand up to hard driving. A few of us, including myself, were

assigned to running loading tests, and if we received a car which we thought ran badly, we had to get rid of it as quickly as possible. So we drove it to a long uphill gradient outside Trollhattan, where we ran it with a small throttle opening and in high gear. The procedure never failed - the engine inevitable seized and we had to be given a new car.

When a two-stroke ran well, it was almost unbeatable - we could leave appreciable more powerful cars far behind, even though we only had a three-speed gearbox. We decided once to fool the Germans who were our keenest competitors. Immediately after the start of the Geneva Rally, I screamed through the gears in front of the public. At full engine speed in top gear, I eased the throttle, declutched and then pulled away again - still in top gear, of course, since we only had three gears. The Germans immediately protested that we equipped our cars with four-speed gearboxes...

Two-stroke engines are easy to work on. On the way home from a competition, my three-cylinder engine seized solid. The only tools I had was the usual tool kit and a hacksaw blade. With only this at my disposal, I managed to lift out the engine and dismantle sufficiently so that I could enter the hacksaw blade to saw off the connecting rod of the piston which seized. I then reassembled the now two-cylinder engine, and made it home to Trollhattan.

One of my most memorable rallies was the 1959 Dutch Tulip Rally. I drove an unbelievably temperamental two-stroke which had the nasty tendency to oil-up the sparking plugs. Just before the special trials on the Grand Prix in Zandvoort, I was not allowed to touch the car before it was time to drive out onto the track. One of the plugs naturally oiled up when I was about to drive out onto the starting line, and I had no choice but to change the plug myself. I was fifth off the line and had a tough duel with the Englishman John Sprinzel during the first laps. But he had the misfortune of driving out into the sand dunes just as I was about to overtake him. It poured down with rain and I was truly grateful for the front-wheel drive. I overtook one after the other, and in the last curve, I overtook the leader - a Porsche 1600 CS. Luckily, the finishing line was just after the bend, so he never had time to get back into the lead.

The second time I won the British

## OVERSEAS AUTO PARTS

KYB GAS SHOCK **\$23.40**

99/900 MUFFLERS WITH  
CONNECTOR PIPE **\$52.82**

MANN OIL FILTERS **\$6.26**

BALL JOINTS **\$25.95**

REPCO METAL MASTER  
BRAKE PADS-  
FROM **\$19.94**

NGK SPARK PLUGS **\$1.65**

HALOGEN BULBS-H9004  
**\$9.95**

AIR FILTERS **\$5.95**  
99 & 900 NON TURBO

REBUILT STARTERS,  
ALTERNATORS, CALIPERS,  
BOSCH IGN. & F.I. PARTS  
AND LOTS MORE!!!!  
AT DISCOUNT PRICES

M/C AND VISA WELCOME  
WE SHIP ANYWHERE

OFF BRIDGE STREET  
BRATTLEBORO, VT 05301

U.S. (800)544-4600

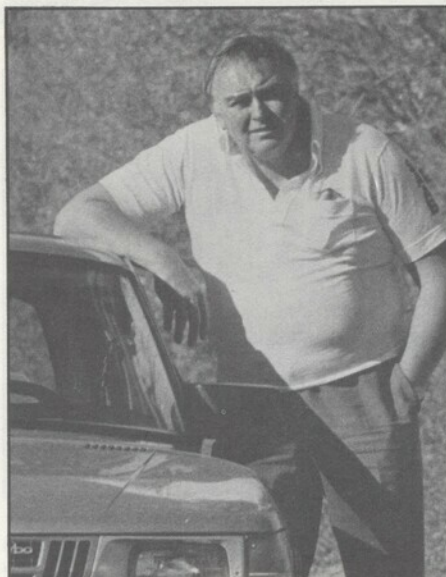

RAC rally in 1961, I lost a rear axle stay on my 96. The Saab was not common in England at that time, but we were fortunate to find a brand-new 96 parked along the road. The owner was presumably further up in the woods watching the rally, so we took the liberty of hoisting up the car and removing the stay we needed. Just as we were finishing, the owner appeared on the scene in a fuming temper. He even threatened to call the police. Fortunately, we talked him into letting us continue, promising that we would replace the stay after the race. We won the race and my "spare parts supplier" and myself became the best of friends. We keep in touch to this date.

But it wasn't all a bed of roses. In 1959, I was extremely close to becoming European Champion, but the turn of events at the final in Portugal decreed otherwise. The rules stated that the competitor numbers were to be marked on the door in black numerals on a white background. Since my car was blue, I thought it would look more attractive to have white numerals on a black background. That made no difference to the race - I won the European Championship. Or that's what I thought. One of my competitors filed a protest against the colour of the competitor numbers and the extra penalty points lost me the European Championships. Not exactly the best of sportsmanship, but it taught me to read the small print in rules.

The Swedish Rally to the Midnight Sun has long been one of the most enjoyable and warmest races. From 1965, the rally was

run during the winter and its name was also changed to the Swedish Winter Rally. And it was also cold - temperatures of -40°C (-40°F) were not uncommon. In 1966, the crankshaft seized and we dropped out of the rally in the middle of nowhere. To make things worse, we had taken a short-cut, so we were outside the actual rally route. Just as we were about to start removing the interior to set it on fire, one of our "stable-mates" came along. On arrival, we found out that the temperature was -43° C...

The African Safari Rally is the direct opposite to the Swedish Rally. We were close to winning several times, and we led the rally by more than one hour in 1963. We took it easy, avoiding all risks. But on the last night while driving in the blackest of African nights, a strange animal emerged from the four-foot elephant grass. Everything went black. It took some time before we dared get out of the car to find out what strange animal we had hit. It proved to be an ant-eater. After patching up the car, we continued for awhile but had to give up in the end. The only consolation was that the organizers had a hat made out of the ant-eater skin. I kept it as a souvenir for many years.

My years as a rally driver were exciting and certainly not dull. I started in two-cylinder cars, which then became three-cylinder and finally four-cylinder. So developments have forged ahead. In 1967, I won the first international victory with a V4 engine Saab. That was the Czech Rally. And the "Baja 1000" Rallies in 1969 and 1970 were my last competitions.

We used to prepare ourselves meticulously in the European competitions, whereas the Americans took things a lot easier. I remember that we long had the company of a couple of cheerful American in a dune buggy which they could drive appreciably faster than we in the roughest terrain. They overtook us four times during the race, but we overtook them only once. I have no idea what they did in between, but since we crossed the finishing line first, they must have spent their time sightseeing. A couple of their colleagues overtook us on a steep sand dune, only to overturn head-over-heels in the next instant. They hung there with their seat belts fastened. We stopped and helped them back on their wheels, while they still hung in their harnesses. They thanked us for our help and carried on...



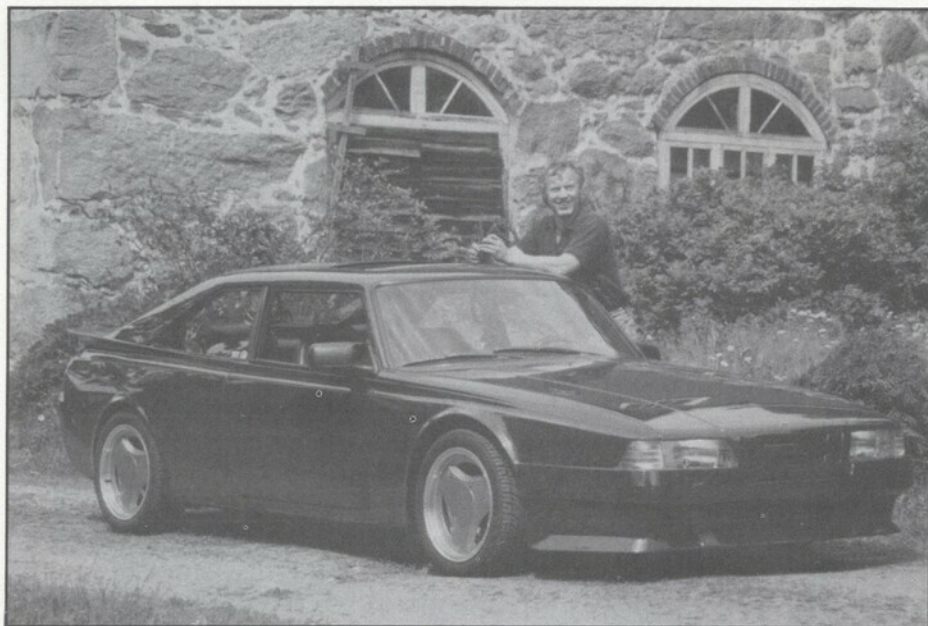

## LACAR in a league of its own

by Torbjörn Lundgren

Lasse Karlsson - Saab devotee, car builder and former rallycross ace - has struck again. In 1987, his red gullwing Saab 99 won the title of "World's Hottest Saab". Now he's back in the limelight with his LACAR - a sports coupé based on the Saab 900. Wide, low, red, sleek - and fast.

"I wanted to build something akin to a sports car. I set my sights on creating something no one else has done. And I wanted to make it as wedge-shaped as possible."

Lasse Karlsson, from the town of Ryd in southern Sweden, sits on a meadow and tells the story of his latest creation. Behind him is the LACAR, its Talladega Red paintwork sparkling in the sun.

Lasse is a car mechanic at Saab in Fridafors. His job slots perfectly into his car-building project.

"Saab in Trollhättan were very helpful with car parts. They gave me a generous discount on everything I needed."

And just look at the car parts! He's certainly done it - again to be exact.

Lasse entered the 1987 Saab competition in Nyköping. Even though he didn't rate his chances very highly, his car won unchallenged title of "World's Hottest Saab". His creation then was a Saab 99 with gullwing doors.

Lasse was in the rallycross game in the 1970s, driving a Saab of course. His often brutal successes won him the nickname of "The Roller".

But Lasse is now content with spending his spare time building cars. The LACAR, a combination of his first and second names, was ready in May of last year after 18 months in the making.

### Most of it modified

"I started with a 1982 three-door

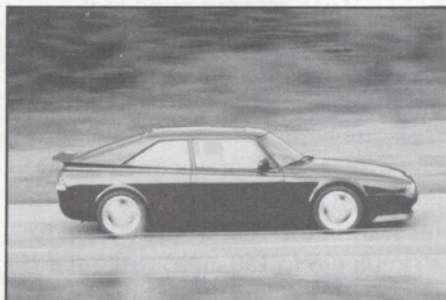

Saab 900 with sunroof. Not much of the original bodywork remains."

We certainly can't dispute that! Low, wide and with smoothly sweeping lines. The LACAR really is nothing like any other car - or perhaps like all of them rolled into one.

The basic idea was that the wing (fender) would start right at the front flasher and gradually slope up to a wing at the rear.

"I have cut and reversed the bonnet (hood). The hinges are now at the rear and the bonnet opens upwards from the front. I have moved the creases in the bonnet a couple of centimetres outwards.

"The side, up to the first crease, is original. From this line upwards, I have modified everything. I have beaten most of it by hand out of raw sheet steel. The roof is shorter. I sloped the A pillars backwards to increase the windscreen slope. The windows are original, except for the rear side windows which are cut down. I moved the windscreen wipers down below the bonnet line."

### Started from sketches

The bodywork job is impressive. All modifications have been done in the sheet steel, with a minimum of filling. The wing flares sweep out smoothly. All creases and angles are in perfect harmony. Lasse has succeeded in the difficult art of achieving pleasing proportions. Much of his success doubtless stems from his painstaking preparations.

"I started by drawing the car to scale. I must have drawn almost a hundred sketches before I was pleased with the lines. My drawings were as accurate as possible. I would never have succeeded otherwise."

The wheelbase remains unchanged, but the wheels are one inch further out, for which Lasse used spacers.

In spite of the massive modifications, the car is an unmistakable Saab, which is what Lasse was determined to achieve right from the start. And the

### Recipe

Car: Lacar sports car based on a 1982 Saab 900 3-door, with more recent Saab components added.

Owner/Builder: Lasse Karlsson of Ryd, Sweden.

Body: Lowered, sectioned, shortened by 25 cm and the wings widened by 8 cm on each side. The door locks moved to the tops of the doors, the tailgate cut below the rear window, the roof lowered and shortened 7 cm at the front and 15 cm at the rear, with windscreen and rear window given a more pronounced slope. New C pillars integrated into the rear wing, front spoiler of own manufacture.

Engine: Saab 1995cc with twin overhead camshafts, 16 valves, turbocharger and intercooler. Bosch LH Jetronic fuel injection.

Engine rating: 175 bhp at 5500 rpm, with peak torque of 273 Nm at 2800 rpm.

Transmission: Front-wheel drive through 5-speed Saab gearbox.

Wheels: 7x16" Saab light alloy Talladega.

Tyres: Goodyear 205/45-16.

Suspension: Genuine Saab, supplemented with anti-roll bars from the Saab Turbo and Boge progressive shock absorbers.

Interior: Black leather upholstery with red insets, leather-trimmed sports steering wheel, Saab instruments.

Paintwork: Talladega Red, sprayed by Ulf Thöjesson at Fridafors Bilservice AB.

Building time: 18 months.

Acknowledgements to:  
Saab Automobile AB in Nyköping and Trollhättan,  
AB Fridafors Bilservice.

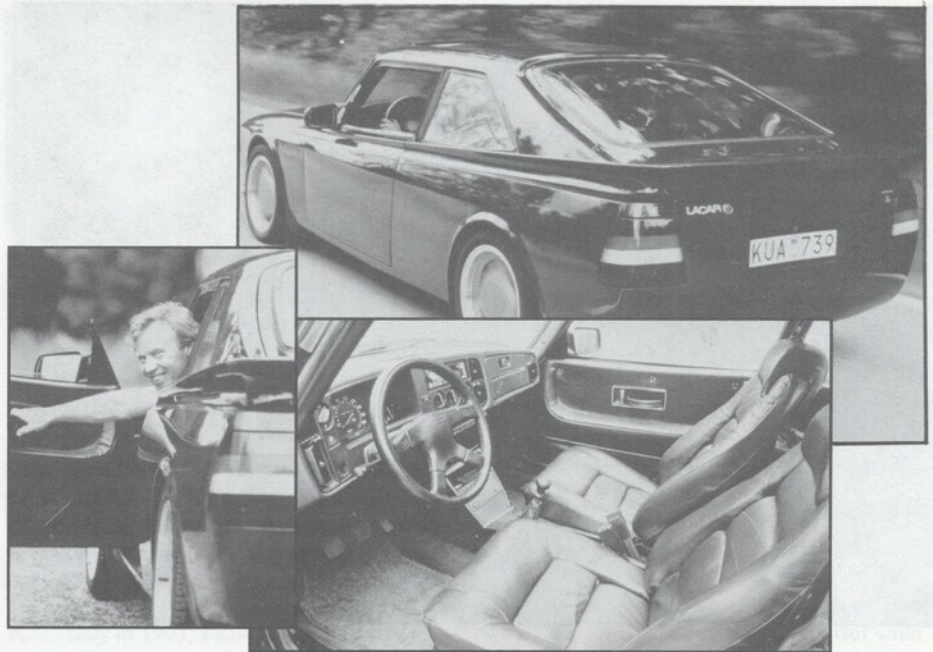

Talladega wheels, the 9000 rear light clusters, the roof line, the double stylised Saab grilles - they all helped along.

How about the headlamps then? "That's something you shouldn't have asked," sighs Lasse. Lasse turned out to be almost allergic to Japanese cars. He can say real nasty things about Mazda, Toyota, Nissan & Co. "The headlamps wouldn't be from...?" "Next question, please."

### Function follows form

So the LACAR does have very neat lines. But Lasse was determined that the driveability of the car would at least match its looks. It's driven - and driven fast. A 175 bhp Saab 16-valve Turbo engine lurks under the bonnet.

"Have you tuned it?"

"No, it's a standard engine. But you could squeeze around 260 horses out of it if you set your mind to it.

"As it is, you can wind her up to a good bit over 240 km/h (150 mph). And you lose a lot of tyre rubber if you accelerate hard."

Lasse lavishes praise on the Saab engine. "It's a fantastic machine. I can pull away in top gear from 40 km/h to 240 km/h (25 to 150 mph) without a murmur. It has incredible urge."

Lasse lowered the engine mountings to accommodate the turbo engine under the low bonnet. So the engine is now 4 cm lower than it was originally.

With the new, genuine Saab suspension - with anti-roll bars from the Turbo model and progressive Boge shock absorbers - and a set of wide Goodyear tyres, the car hugs the road impressively.

"The roadholding is superb. Drive her as fast as you like, and she'll stick to the road like a leech." The springs are two turns shorter. The ground clearance is only 7 cm.

"That's as far as I can lower it and the ride may be a little bumpy now," says Lasse.

The only thing he thought was particularly difficult was the upholstery. Black leather adorns the original Saab 900 seats.

"I found that difficult. The trim on the doors and in other places is very hard to do well, and I'm not all that pleased with the result. I have thought of redoing it, but I'm not all that good at interior trim."

There are patches of red in the black leather.

"The wife's old skirt," says Lasse with a grin that made us wonder whether the wife hadn't found out yet.



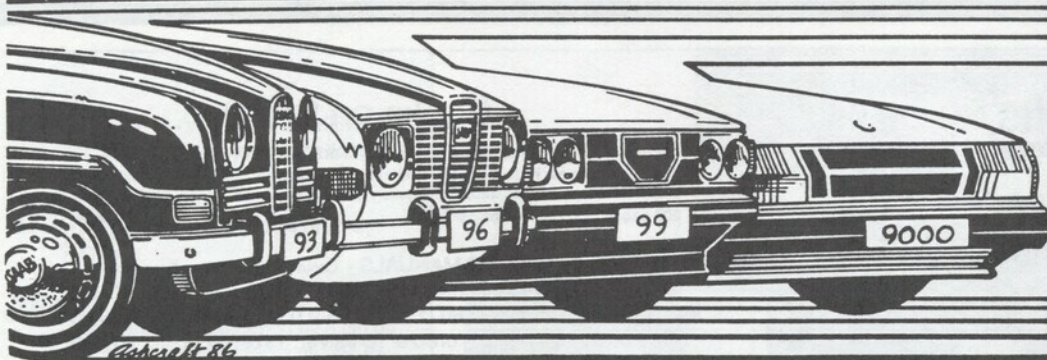

# SAAB SWAP

CLASSIFIED ADS

## CLASSIFIED AD RATES

Ads offering parts or SAABs for sale or wanted are available to members and non-members. Ads are limited to 25 words, plus name address and phone number. Ad copy will be abbreviated and excess words deleted where possible. Enclose sufficient funds with your ad, we do not bill. No ads will be taken by phone. The Classified Ad rate is as follows:

	Members	Non-members
CARS FOR SALE	\$10.00	\$15.00
PARTS FOR SALE	\$5.00	\$7.50
WANTED ADS.	\$2.00	\$3.00
COMMERCIAL ADS (Parts & Services)	\$10.00	\$15.00

DEADLINE: The 15th of each month for the following month's issue, e.g. January 15th for the February issue. Newsletters are mailed the first week of the cover month.

COMMERCIAL DISPLAY ADS: Contact the editor for rates and info. Deadline, the 10th of each month for the following month's issue.

### Sonett (97s) For Sale

'74 Sonett III, ground up restoration: engine, paint, metal, interior. Blue, excellent condition. \$4,900 or offer. Samuel Girgis, Oak Brook IL. 708/323-3330.

'74 Sonett III, 53k mi, AC, looks good, runs great, int. good, new trunk pan. \$2,500 obo. Ray Kurr, Tulsa OK. 918/451-2899.

'74 Sonett III, good body, paint, interior, tires. Floor pan rebuilt. Extra transmission. \$1,550. Dennis Sweeney, RD 1 Box 410, Ligonier PA 15658. 412/238-0900.

'72 Sonett III, with rubber bumpers, Red, new trans bearings, clutch & brakes. Runs & looks good. Driven daily. John Plankey, 8996 130 Ave N, Largo FL 34643. 813/584-7147 W, 813/393-3816 H.

### 93s, 95s & 96s For Sale

Restored 71 95, \$3500 lacquer paint (orig. Beige), many spares incl new trans. Stored 9 years, not driven winters. Excellent condition. \$4,500. Located in MA. David MacLean, St. Louis MO. 314/542-0790.\*

Last chance offer! 4 '68 & '70 95s, 1 '70 96. Good bodies plus numerous parts. \$1500 or \$300 each obo. Bob Englehart, PO Box 1476, Ames IA 50010. 515/232-4477.

'67 96, Factory new 2-stroke engine, triple carbs, Dist. (original engine incl.). New brakes, shocks, heater valve, exhaust. Rblt radiators, freewheel. Exc. orig interior & body. \$4,750. Geo. Pouridas, Chatsworth CA. 818/882-9950.

'67 96, strong GT-850 engine & trans, original blue paint. Solid car, run every day. Many new & rebuilt parts. \$1,500. Ed Carney, Wilmington DE. 302/999-8796.

'65 96 Monte Carlo 850, original condition, no rust, good shape, complete. Runs & drives great. \$3,800 obo. Earl Burns, Lincoln NE. 402/435-7450.\*

'65 95 wagon, perfect body, never any rust, extra Sonett alloy wheels, original car top carrier, dealership shop manuals, many extra engine & trans parts. \$2,500. Ed Parauka, 4268 Richmond NW, Walker MI 49504. 616/791-9519.\*

'64 GT-850, vy good cond, driven weekends. No rust, extra engine (non-GT), many misc. parts, manuals. \$3,950 obo. Vic Palumbos, Grapevine TX. 817/685-8076 after 7pm

'60 93F, body good, complete but not running. '70 96, sill & wheel well rot, otherwise good body, engine & trans good. Best offer. Ned Renner, Towson MD. 301/583-9272.

### 2-Stroke & V4 Parts

Weber 34-ICH carbs, easy replacement for V4s, includes linkage & instructions, NEW. We take Visa, MasterCard, Discover. Swedish Express Inc, 920 1/2 E First St, Duluth MN 55805. 218/724-2466.

'68 96 doors (Tuff Koted), no rust, \$150 ea. '73 RH door, some dents, \$75. Ronald Pidgeon, RD #1 Box 1960, Vergennes VT 05491. 802/877-2643.

Shop Manuals: V4 1967-1970, \$75. 1965-1968 Monte Carlo, 2-stroke & V4, \$100. 1960-1964 95, 96 & GT-750, \$100. Ronald Pidgeon, RD #1 Box 1960, Vergennes VT 05491. 802/877-2643.

'68 Sonett V4 parts car, no glass or rear clip, trans apart, engine good but some bolt ons missing. May part out. \$500. Ken Burson, Omaha NE. 402/551-9665.

V4 Parts: motors, trans, drive axles. 3 Sonett rear clips. Call for price. John Plankey, 8996 130 Ave N, Largo FL 34643. 813/584-7147.

Rare parts for all 2-stroke & V4 models; new orig. 96 cloth sunroof, bed kits, everything you can dream of. Oded Mandelblatt, PO Box 1049, Ramat-Gan 52109 Israel. Phone 8/231-237.

### 99s, 900s & 9000s For Sale

'90 900 SPG, Black, 8,500 mi, extended warranty, \$22,000. '87 SPG, 82k mi, \$9,800. L. Smith, 974 W Bloomfield Rd, Huneoye Falls NY 14472. 315/986-4062 W, 716/624-3839 H.

'88 9000S Auto, Dk Grey, 4dr HB, 34k mi, Excl. Asking \$11,000 obo. Tom Higgs, 601/924-7631 eves to 10pm CST.

'88 900 SPG, 77k mi, clean runs great, all OEM equipment plus some aftermarket parts. \$14,000. Barry Ling, 5082 Rolling Ridge Dr. Seville OH 44273. 216/722-2354.

'86 9000 Turbo, Red w/tan leather, sports pkg, sharp, mint cond, 70k hiway mi. \$9,200 obo. Samuel Girgis, Oak Brook IL. 708/323-3330.

'86 900S, 16-vlv, 5spd, 2dr coupe, White w/blue-grey interior, 75k mi. Original owner, service records, excellent condition. \$7,500. Andy Augustinas, Peoria IL. 309/688-4493.

'84 900 Turbo 4dr, 5spd, Maroon w/tan interior, 85k mi, sunroof, wind deflector, PW, PL, AC, CC, Blaupunkt, new tires, front shocks, heater valve. 2nd owner, very clean, \$5,500. Norman Erickson, 6230 NW 34th Ave, Rochester MN 55901. 507/288-0819.

'80 900 Turbo 3dr, 156k mi, needs head gskt, turbo seals, some body work. \$995 or will part out. Jim Fortune, 7712 Asherton Ln, Chattanooga TN 37421. 615/875-7971 days.

'78 99 Turbo, under 80k mi, 1 owner. Recent work: new turbo & beefed up gearbox. Body & interior great condition, rustfree chassis. Mechanically strong, smooth & fast. \$3,995. Leonard Casper, Lititz PA. 717/627-0992.

'78 99 Turbo, Red, 105k mi, solid body, interior, nice Incas, good tires. Runs good. \$950. Dennis Sweeney, RD 1 Box 410, Ligonier PA 15658. 412/238-0900.

'78 99 EMS, 120k mi, Maroon/Maroon, pdl, pm, never wrecked but rusty. Recent: rebuilt head, fuel inj, MSS headers & exhaust, rebuilt brakes, rear KYB shocks & more. Needs timing chain & ft whl brngs. \$500 obo. Barry Ling, 5082 Rolling Ridge Dr, Seville OH 44273. 216/722-2354.

'76 99 GL Wagonback, auto, Tan, 93k mi, no rust, exc, eng. small trans leak, EMS mags w/ snows, good interior, many new parts, driven daily, spare parts. \$650 obo. Lorenzo Diurno, Waterbury CT. 203/596-7001 days or lv msg.

'74 99 EMS for parts or whole. Alloy wheels, 4 Michelin studded snows, 2 on steel wheels. All offers considered. Robert Perry, 39 Elm St, Hingham MA 02043. 617/693-5045 9-6 M-F.

'74 99, .020 over block & Mahle pistons 20k mi, air dam, nearly new heater core. Eliot Shanabrook, 794 Boston Post Rd, Weston MA 02193. 617/891-6330.

'72 99E, 193k mi, one owner, all records, many newer parts. Runs, but needs valve job or overhaul. Body good, interior fair. \$400. Jim Kaplan, Columbia MD. 301/740-5185.

### 99, 900 & 9000 Parts

99 & 900 OEM parts, wholesale prices to SAAB Club members. Aftermarket parts, engines, transmission, large assortment of used parts. New cylinder heads, 81+; new-style heater control valve; new-style outer CV joint. Call for price and availability. Installation and service available. Mastercard and Visa accepted. Trollhattan Motors Inc., 310 George Ave, Baltimore MD 21221. 301/682-4688 or 1-800-32-TROLL. Evening and Saturday hours.

99 & 900 Headliner Kit, comes with glue, 3/2 yards of material and complete instructions, \$87.50. Other parts available. Trollhattan Motors Inc., 310 George Ave, Baltimore MD 21221. 301/682-4688 or 1-800-32-TROLL. Evening and Saturday hours.

Factory Manuals - 99: Service manual, softbound, poor cond; spare parts, 5 languages binder, 69-73; spare parts binder, 74 on. 900: Service manual (79 on), four binders; Service Information binder; Standard times binder. 9000 Service manual (86 on), three binder; standard times binder. All in new or perfect condition except where noted. Best home gets best price. Simon DuStroke, Ontario Canada. 519/767-0819.

Parting out: '80 99. Most parts available & working, no shipping, pick up in Auburn, Maine. Scott Sawyer, 207/782-0549.

Back issues of SAAB Club Newsletter, Nov/Dec '76 thru Dec '89. \$60 incl shpg. Paul Hanson, 1217 W Walnut, Chillicothe IL 61523.

900 & 9000 parts: 79-90 engines, trans rebuilt & used, interiors, headliners, wheels, new & used turbos, much more. European Car Parts, 57 N Plains Industrial Rd, Wallingford CT 06492. 203/284-8989.

4-volume bound set of Saab Service Supplement and Tips, 99/900 -86. Complements Saab's Service Manuals. NEW! \$85. Andrews Inc, Princeton MN. 800-882-7220.

Your SAAB manual transmissions rebuilt from \$795. Includes replacement of bearings and seals, and set to factory specs. Why buy used and not be sure? Call for details. Freight additional. Mastercard and Visa accepted. Trollhattan Motors Inc., 310 George Ave, Baltimore MD 21221. 301/682-4688 or 1-800-32-TROLL. Evening and Saturday hours.

Parting out: fifteen 99s and nineteen 900s, 1973 thru 1988, one '86 9000T. New OE sunroof deflectors, 9000 only, \$39.00. Quantity discounts. Rod Beckner, 604 E First St, Albany OR 97321. Tele/fax 503/928-6351.

Hella European headlights for 900s thru '86. Very good condition, \$275. Jim Fortune, 7712 Asherton Ln, Chattanooga TN 37421. 615/875-7971 days.

Saab Sheepskin seat covers for 900. Burgundy, set of 2, fully lined, like new condition, used 3 months. Listed at \$499/pr, will sell for \$75. Don Hunsaker, Rt 2 Box 252-C, Kingston TN 37763. 615/574-5802.

Exhaust system for '82 900T, from turbo to muffler, with converter. Very good condition, \$150. Complete head for 80 900T w/valves & cam, casting is bad. John Horvath, Carlisle MA. 508/371-2130.

Saab/Hella Euro headlights, 79-86 900, New. \$175 ea or \$300/pr. Andrews Inc, Princeton MN, 800-882-7220 or 612/389-3805.

Four 24-spoke alloys, very good condition, \$260/set or \$80 ea. Power antenna motor from '83 900T, mast & cable broken, free +shpg. John Swansey, PO Box 6117, Kingston NY 12401. 914/385-6077.

Saab 24-spoke (#0024489) rims. MSW Type 2 'wire' alloy rims w/Michelin MXVs. TRX wheels & tires. 85-mph speedo, \$25. Many '81 900T 4dr parts. Pedro Tai, 905 W Ream Ave, Mt Shasta CA 96067. 916/926-5473.

### Wanted, All Models

For '69 Sonett V4: Window regulator for drivers door p/n 74-12-166. Have one from Sonett III for trade if interested. Dick Ginsburg, 392 S 9th Ave, Cornelius OR 97113. 503/357-8504.

Rear glass for Sonett II/V4. Will trade for Sonett II parts car complete & give \$ for rear glass. Ken Burson, Omaha NE. 402/551-9665.

Steering rack in good condition for '72 99 1.85, or complete parts car. Bert Lustig, Rt 3 Box 192-L, Berkeley Springs WV 25411. 304/258-1195.

For '69 96: rear bumper, left backup light, rear sheel hub nut caps. For '86 900T: 4 Shelby, SPG or Inca wheels in Excellent condition. Jim Schlueter, 1639 N Bend Rd, Cincinnati OH 45224-2023. 513/691-2800.

For '72 96: Front seat bottom & back cover, green. No rips, holes or repairs please. Alan Fein, 1047 Sylvia Ln, Tampa FL 33613. 813/969-1808.

88 or 89 900T 3dr, 5spd or SPG. Must be in mint or exc. cond, with low mileage. Would prefer Rose Quartz w/red leather. David L Adams Jr, 17107 Invermere Rd, Cleveland OH 44128, 216/751-8109.

Rear decor panel to fit '89 SPG. Must be in exc cond. Tonish Jones, 9994B Saint Onge Ave, Ellsworth AFB SD 57706. 605/923-4728.

68-72 96 V4 with 1700cc engine. Must be drivable and in California or Nevada. Bad tranny okay. Vilis Ozolins, Rt 1 Box 1002, Crowley Lake CA 93546. 619/935-4336.

Saab Club Newsletters from Jan 84 to Oct 87 (#121 - #163). L. V. Majoch, 504 Crestview Dr, Milford DE 19963. 302/422-6608 or 422-9321.

Two SPG wheels, must be straight. Frank, 1-800-999-1820

Plastic trim NOS windshield & rear window for 1972 96. Exhaust heater box for V4. Ronald Pidgeon, RD #1 Box 1960, Vergennes VT 05491. 802/877-2643.

## Seven Sensible Signals for safer driving

(as recommended by the National Motorists Association)

### APOLOGY - (I'm Sorry)

In a brief lapse of attention or judgement, you unintentionally inconvenience, irritate, or endanger another motorist. You feel embarrassed and the other driver is angry. Neither state of mind produces safe, courteous driving.

The "Apology" signal can diffuse the destructive anger and frustration that follow these unfortunate encounters. To signal an apology, hold two fingers in a "V" position, palm out.

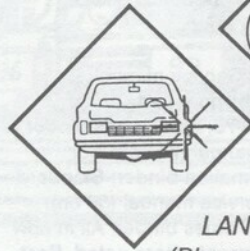
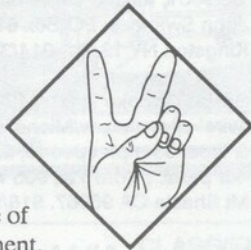

### LANE COURTESY (Please Yield Left Lane)

While traveling on a multilane highway you wish to pass another vehicle that is in the left "passing" lane. The "Lane Courtesy" signal will alert the other motorist of your intention.

Signal your intention by turning the left directional light on and off, 4 to 6 blinks at a time. If the slower vehicle does not respond to the left turn signal, briefly flash your headlights to gain the attention of the other driver.

If you see the "Lane Courtesy" signal from the motorist behind you, check the adjacent right lane, pull over when it is safe to do so, and let the faster vehicle pass.

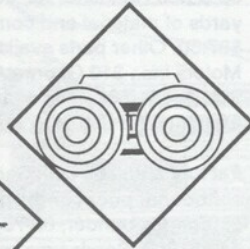

### LIGHT PROBLEM (Check Your Lights)

The directional lights on another vehicle have been unknowingly left on. You see a vehicle with a burned out headlight or taillight. You would like to alert the other driver to the problem.

To signal a motorist to "check your lights," open and close your hand touching the thumb and finger tips together.

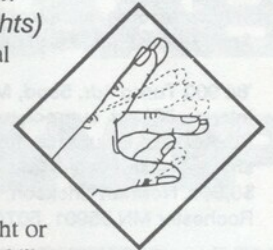

### NEED ASSISTANCE

You are pulled over to the side of the road and need help. Most passersby are unsure what help, if any, is needed. You need to signal for help without conveying panic.

To signal for assistance, make the sign of a "T" by crossing one hand above the other.

If you see the "Need Assistance" signal, you must make a decision whether you will stop, phone for help, or ignore the appeal.

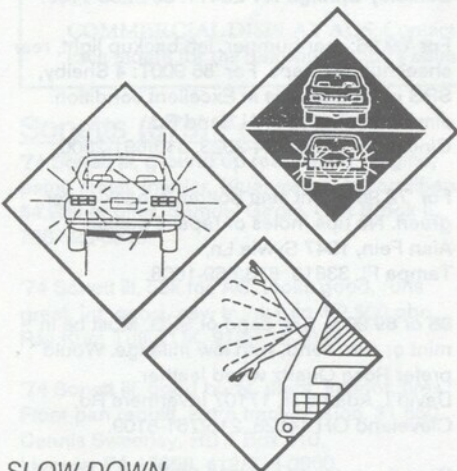
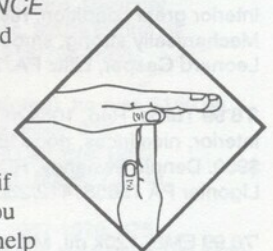

### SLOW DOWN, DANGER AHEAD

You see an obstacle in the road and would like to alert other motorists to the potential danger. The "Slow Down" signal will warn others of an accident, obstacle, or any dangerous condition.

To alert traffic approaching from the opposite direction, turn your headlights off and on. To alert traffic approaching from the rear, activate your brake lights or extend your left arm and motion downward.

If you see the "Slow Down" signal from another motorist, heed the warning.

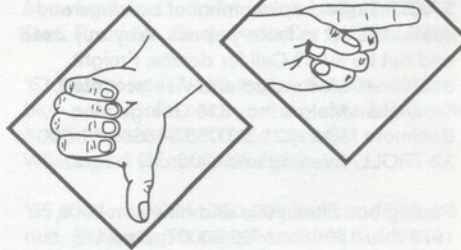

### PULL OVER FOR PROBLEM

You come across a vehicle about to have a flat, or lose luggage from an outside rack or litter the highway with skis, bicycles or furniture. The "Pull Over For Problem" signal helps you alert the other driver.

To alert another motorist of a problem with his or her vehicle, first point in the direction of the problem (up for loose roof rack, back for trailer problem, etc.), then signal "thumbs down."

If you receive this signal from another motorist, pull over and check your vehicle.

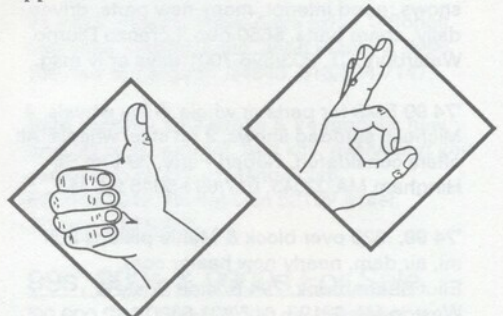

### I UNDERSTAND (Thank You, I Understand)

To acknowledge another motorist's signal...an apology, light problem or problem pull-over signal, for example, or to thank another driver for a courtesy, use the well-understood "thumbs up" or "OK".

Provided by:

**National Motorists Association**

6678 Pertzborn Road  
Dane, Wisconsin 53529

## MEMBERSHIP/SUBSCRIPTION

(Use also for Change of Address)

NAME \_\_\_\_\_

ADDRESS \_\_\_\_\_

CITY/STATE/ZIP \_\_\_\_\_

HOME PHONE \_\_\_\_\_ WORK PHONE \_\_\_\_\_

SAABS CURRENTLY OWNED \_\_\_\_\_

(i.e. '84 900 S 4dr. automatic / '78 99 GLE 5dr. 4-spd / '72 Sonett III / '68 96-V4 Deluxe)

Address change only - old Zip Code \_\_\_\_\_

Annual Membership fees for the SAAB Club of North America/NINES are as follows:

First Year \$29.00  
 Renewal \$25.00

Canadian add \$4.00U.S.  
 International add \$8.00U.S.

Please check appropriate box(es)

(Canadian and International - Money order or check payable on a U.S. bank only. Cash OK.)

First year members receive two recent back issues of NINES and two SAAB Club stickers.

MAKE CHECKS PAYABLE TO "THE SAAB CLUB"

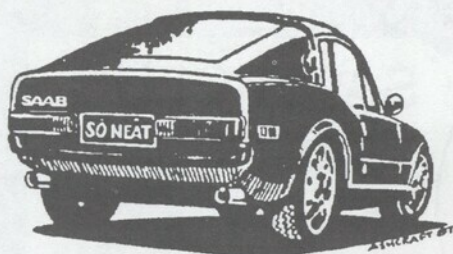

## Rear View

It's another year full of anniversaries.

The SAAB Club National Capitol Area celebrated its 30th anniversary early in March. The Stockholm SAAB Club is also celebrating its 30th year, with an International meeting of SAAB Clubs in June. The Chicago Club has been in existence for 20 years this month.

1991 is also a milestone for Saab. The SAAB 93 went into production in December 1955 as a 1956 model. The 93 made its official American debut 35 years ago at the New York auto show in the spring of 1956. SAAB Motors Inc. under the direction of Ralph Millet began operations in the U.S. that year.

Speaking of Saab's good-old-days, Simon DuStroke has written a series of historical articles on the two-stroke SAABs. Watch for them beginning in the next issue.

Saab's former Public Relations manager, Len Lonnegren, has also agreed to put some of his Saab tales on paper. Those who have listened to Len's stories at the annual conventions know that we have something to look forward to.

In researching some of the history of the Chicago SAAB Club, Andy Federowski ran across a copy of the Summer 1971 *Saab*

*Soundings*, the magazine Saab sends to its owners.

Among the announcements by Saab in that issue -- a new name for the U.S. distributor: Saab-Scania of America, Inc. A new president for the company was also introduced; Mr. J. J. "Jerry" Upham, who took over from Ralph Millet, founder of the Saab distribution network in the U.S. (Mr. Upham was with Saab only a little over a year.) Construction of a new U.S. headquarters building and parts depot in Orange, Connecticut is also covered.

Articles of interest: Saabs in competition at the Baja 1000, winter rallying and ice racing, and the East African Safari Rally; a trip from Alaska to the southern tip of South America and back, a journey of 50,000 miles, in a Saab 96 V4; and the safety of roll cage construction and headlight wiper/washer systems.

Every now and then someone asks why the SAAB Club doesn't have a toll-free phone number. We don't get many phone calls here, and if there were more that would mean less time for yours truly to handle the editorial work. The cost of a toll-free line would also add a couple of dollars per member per year to the current membership rate, but only a small percentage would use it.

The SAAB Club can't afford to keep a mechanic on the staff, so if you call with a technical question you get me. When I get a request for a phone diagnosis, I preface my response with, "I'm not a mechanic, but here are some possibilities..." "After all, free advice is worth what you pay for it.

I have discussed with some knowledgeable technicians the idea of a "900" phone number, where the caller pays for every minute that they take advantage of the mechanic's experience. Again, due to the

few calls we now get, the high monthly basic expense can not be justified.

There are some Saab dealers and independent shops that offer a toll-free number for parts ordering. Unfortunately that number is sometimes abused by owners seeking free advice. What's wrong with that, you ask?

First of all, the dealership/shop is paying the cost of the phone call but isn't getting anything in return. Toll-free numbers are meant as an incentive to buy parts from one company over a company that doesn't offer free phone service. A free-advice call also ties up that toll-free line so others can't call in to place orders.

A mechanic who is called away from a job he is working on is losing money, for himself and for his shop. If the shop rate is \$60 an hour (not uncommon at Saab dealerships in some larger cities), that's a dollar a minute. There is a substantial investment in his education, tools and years of experience, so time away for unproductive phone calls is not often appreciated.

This is not to say that mechanics don't like to get calls. Most of them love to talk about cars, particularly those who work on Saabs in independent shops. And the better their reputation as mechanics, the more in demand they are by customers who specify, "I'd like Joe to work on my car," and also by those who seek advice.

If you have a problem with your Saab and you've gone through the repair manual with no success, you have two options; take it to a Saab repair shop where experience and the proper tools should guarantee a solution, or call a mechanic for advice, but only as a last resort. And don't be upset if he tries to cut the call short.

Trying to get back on schedule....

Tim Winker, Editor

# NINES

The SAAB Club Newsletter  
2416 London Road, Unit 900  
Duluth, MN 55812-2221

Forwarding and  
Address Correction Requested

February/March 1991

FIRST CLASS

U.S. POSTAGE  
PAID

PERMIT NO. 1909  
DULUTH, MINN.

FIRST CLASS MAIL

**SAAB**  
**CAMPBELL/NELSON**

**NEW  
FACTORY  
PARTS AND  
ACCESSORIES**

**50 STATE TOLL FREE  
1-800-552-2999**

Edmonds, WA (206) 778-1131  
Visa, M/Card, AMX  
RICH ROBERTS, SAAB PARTS MANAGER

**TROLLHATTAN  
MOTORS inc.**

**SPECIALIZING IN PARTS &  
SERVICE FOR SAAB  
& VOLVO**

- OEM, OE & AFTERMARKET PARTS AVAILABLE
- REBUILT MANUAL TRANSMISSIONS AVAIL.
- PARTS DISCOUNTS UP TO 50% OFF LIST PRICE
- EVENING & SAT. HOURS

**CALL FOR MONTHLY SPECIALS  
1-800-32TROLL**

301-682-4688  
BALTIMORE, MD  
INFO. & TECHNICAL ASSISTANCE AVAIL.

ORDERS SHIPPED WITHIN  
24 HRS.

COD, VISA/MASTERCARD  
ACCEPTED.

**SAAB  
VOLVO**



## SAAB CLUB SPECIALS of the MONTH

Capitol Import Autos  
9201 W. Brown Deer Road  
Milwaukee, WI 53224

Rear Decor Panel	9000 5-door	\$190.00
Cruise Control	900, 89-on	\$285.00
(ask for installation details)		
Third Brake Light Kit	900 4-door	\$60.00
Center Console w/Bokhara Red enclosure, '83 900		\$87.00

Expires April 15, 1991

**WE KNOW SAAB'S**

Prices subject to change  
without notice.  
Expires Month End.

**1-800-225-2528  
FAX 414-355-7831**



**AE**

Open 8 am to 6 pm  
Monday thru Friday