

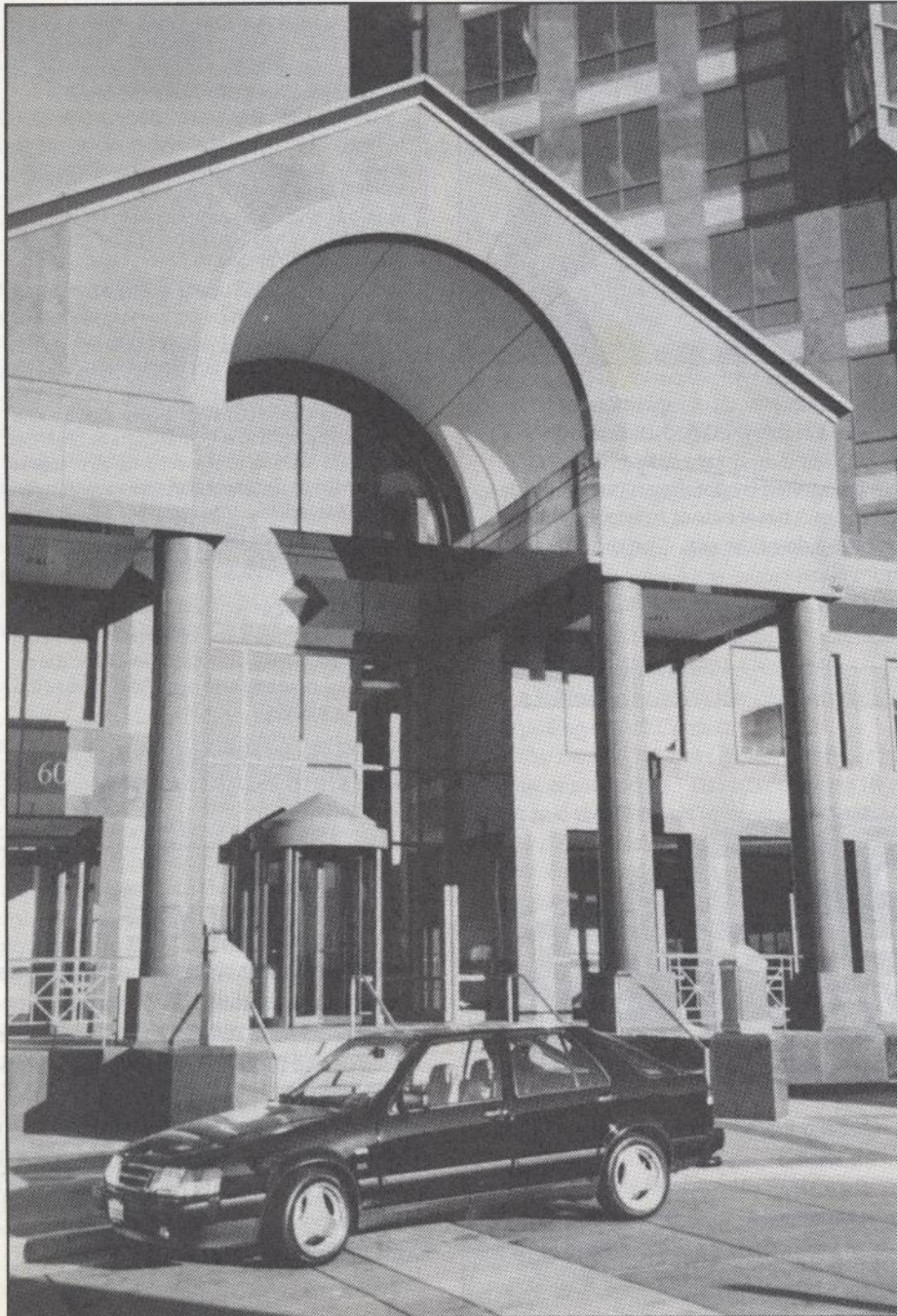

NINES

THE SAAB CLUB NEWSLETTER

\$2.25
October
1990
no. 196



Saab 9000 Turbo 2.3
The *Fastest*
FWD car sold
in America

0 to 60 in 6.4 seconds
Top Speed: 144 mph

Saab for '91

- 900 gets bigger engine
- Repositioning the 9000
- A look at the changes

page 9

The 2.3 Turbo engine in detail
page 10

Driving Impressions

- 2.3 9000 Turbo
- 2.3 9000CD

page 16

Regional Club News

Calendar of Events

Due to the lateness of this issue, all of the events I could cull from the regional newsletters had already passed. Sorry.

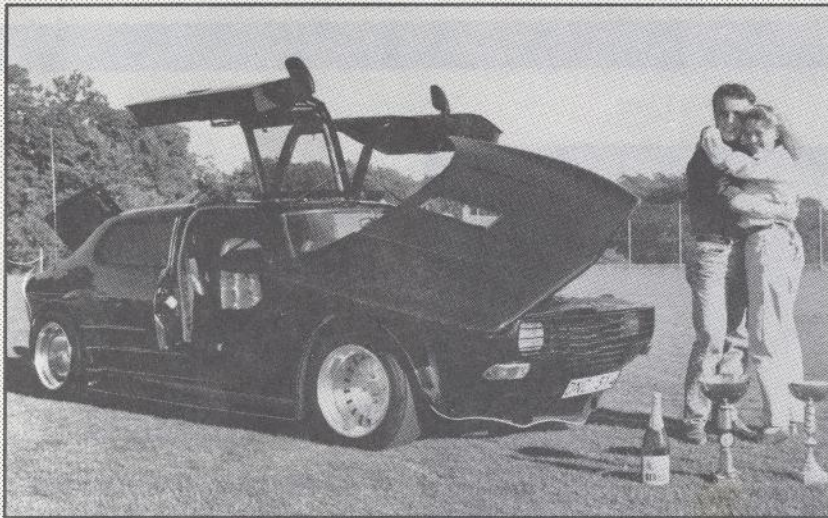

Tomas Persson was the overall winner in the ninth annual competition for the title of "The World's Hottest Saab". His entry was a highly modified 1971 Saab 99.

The body of the 99 has been lowered, widened and equipped with gullwing doors. The trunk lid is in two halves which can be opened by pressing a button inside the car. The hood opens upwards and to the side, and has a cutout to accommodate a set of Weber carburetors. Giant fins run along the side of the car. The three piece wheels were turned by Persson out of aluminum alloy.

Persson is being congratulated by his girl friend, Marie Olandersson.

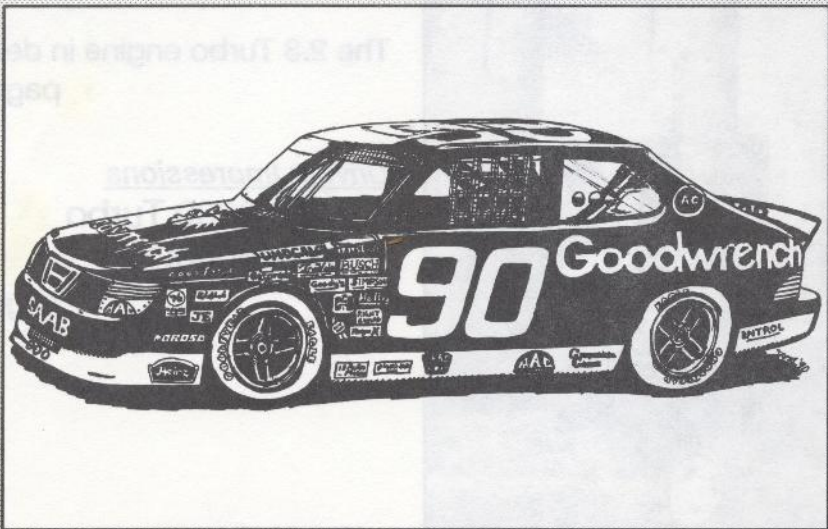

NASCAR 900? Another commentary on the Saab/GM alliance, this one by Jon Anderson of Duluth, MN.

SAAB Club of North America

2416 London Road, Unit 900
Duluth, MN 55812-2221

218/ 724-1336, 9am - 6pm Mon - Sat

Fax number: 218/ 728-6307

(Head fax messages: ATTN. SAAB Club)

NINES Editor & Publisher:

Tim Winker

Membership / Business Manager

Marketta Mannoja

NINES is published eleven times a year (monthly except August) as a service of the SAAB Club of North America. The SAAB Club is not affiliated with Saab-Scania of America, Inc. or Saab Automobile AB.

All material copyright 1990, SAAB Club of North America. Material may be reproduced with proper credit to the author and to "NINES, the SAAB Club Newsletter". The opinions and views expressed in articles are not necessarily those of the SAAB Club and its newsletter, NINES.

Editorial contributions are welcome. All material submitted is assumed to be for publication unless clearly labeled otherwise. Double-spaced typewritten articles are preferred, but most anything is acceptable. We cannot answer every inquiry and reserve the right to edit materials submitted.

Those wishing to submit articles or letters on 5 1/4" IBM-formatted disks, please convert to ASCII text files (<filename>.TXT). Please include a printed hard copy, and a SASE if you want the disk returned.

CHANGE OF ADDRESS: Eight weeks notice is required for change of address. Please send new address and old address, including zip codes, to the SAAB Club at the address above.

RETURNED CHECKS: There will be a fee of \$10.00 charged for checks returned for any reason.

NOTICE

Did you take video (or audio) tapes of tech sessions at the '90 National Convention? The SAAB Club would like copies of the tech sessions and performance panel discussion for our archives, or for possible inclusion in a book. Also seeking good originals of early SAAB factory shop manuals (model 93, 95/96/GT thru '64, 95/96-V4, Sonett II & V4). Contact Tim Winker, 218/724-1336.

Letters to NINES

More on dealer service

Recent letters persuade me to add my name to the list of new SAAB purchasers who are sufficiently dissatisfied with the poor service made available in my area, that I would never consider the purchase of a new SAAB in the future, notwithstanding its engineering attributes. I have heard horror stories from elsewhere as well.

Somewhere between poor assembly at the factory, dealer service which is inept, and Saab customer relations which are almost non-existent, the purchase of a new SAAB in some areas is a losing proposition. The dealer with whom I've suffered is Zumbach in New York City, reported to be the third largest SAAB dealership nationwide. Advise friends to go elsewhere. Before my 9000T had 16,000 miles on it I had to make more than 23 visits there, almost all of which were repeat attempts to repair each of several problems including faulty steering, non-alignment of body parts and window replacements. So as to let the editor know the details but not bore the reader, an addendum consisting of edited parts of letters to Saab accompanies this letter. Any suggestions for dealers and/or mechanics in the NYC area?

Nor should Saab be left off the hook, and here is the one area where I find *NINES* editorial policy to be in need of rethinking. Too often *NINES* has become a vehicle for the positions of Saab, the corporation, rather than for SAAB Club members. I could quote from earlier *NINES*, but the September issue reveals that fault clearly. In the "Rear View" column, the editor mouths the Saab nonsense (in my view) that the customer is that of the dealership and not of Saab. How easily off the hook! That deception is belied by a look at the warranty which is clearly given by Saab and not the dealer. It is therefore not simply up to the dealer as to how service is handled after the sale. A further look at all consumer protection legislation applying to autos will reveal that it is Saab and not the dealer on whom obligations are placed. I have read the Sinclair position before in *NINES* and I am sorry to read it there again.

There is a lot of unhappiness out here, and *NINES* could and should be a useful vehicle for the promotion of some real changes at Saab.

Mel Meer
New York, NY

Don't forget that I am also a SAAB owner who needs service and parts on occasion, so I rely on a SAAB dealer or an independent SAAB repair shop. I am their customer, and I am also a customer of Saab Cars USA, the U.S. distributor, and of Saab Automobile AB, who built the cars. But my transactions will always be with the end supplier, not the distributor or manufacturer.

Saab Cars USA, Inc. encourages customer feedback. They have a Customer Relations department with a toll-free phone number for that purpose. If a SAAB dealer and his customer cannot agree on a solution to a problem, Saab gets involved with its field staff or, ultimately, its headquarters staff.

While your 9000 does seem to have more than its share of troubles and the service department at Zumbach should be better at correcting those troubles, there are obviously SAAB owners who do like the service at Zumbach, enough to make it one of the largest volume SAAB dealerships.

The editorial policy continues as it has been -- any SAAB enthusiast has a right to be heard in this newsletter, whether their ties are closer to the company than just ownership of a SAAB, or if they have something to say regarding the editorial policy.

...and on Canadian dealers

A follow up on my letter concerning Saab pulling out of Canada.

The closest Passport dealer (11 miles) was just closed down. The next closest (18 miles) said they weren't interested in Saab, so they didn't "pick up the deal". The nearest Passport dealer that will service Saabs is more than 75 miles away.

Needing two front calipers for my '85 900, I went to my old dealer and was quoted CDN\$390/set (US\$330). Saab's regular list price is CDN\$244 (US\$190). I guess he has to buy "black market". One of the *NINES* advertisers (Victor Saab) will ship at US\$128.

Saab corporate management has sure left us hanging. It looks like if we want to continue our relationship with Saab products we are going to have to pay an exorbitant price to do so.

Keep up the good work. We need

NINES more than ever.

Doug Catto
Kettleby, Ontario

I can sympathize, Doug. Our local SAAB dealership, which had been selling SAABs in the Duluth area since 1960, recently closed down. They only sold about 20 new SAABs in 1989, hardly enough to stay in business. The next nearest dealership is in the Twin Cities, 150 miles away!

Fortunately, there are independent repair shops in the area that can handle most SAAB work and parts. As you have discovered, there is mail order if I get desperate.

There are now nearly double the number of Saab dealers in Canada due to the tie with Passport. That sounds like good news for most Canadian Saab owners.

About the 900 armrest...

Belated thanks for sending me the July/August *NINES* issue containing your fine writeup on our armrest. For what it is worth, your newsletter is the best I have seen from the standpoint of content and organization. Good Job.

Sales of the armrest are going very well. As is usually the case, we are getting some excellent feedback from owners of this new product. Perhaps some of the comments will be useful to you and your readers.

First, we were misled by Saab when they told us all 900s from 1983 had 6-3/8" seat separation. Seems certain early (circa 1983-'85) models have only a 4-1/2" - 4-3/4" separation. As a result, these owners must use our 4" wide cushion. We will change our price list to reflect this dual-width situation. The 4" cushion will cost \$3 less.

For 900 owners with the "Motion Alarm" switch at the top of the center console, we will supply a modified Special Mounting with a rectangular hole for relocation of the switch. It will look factory.

One creative owner relocated the Motion Alarm switch to the unused knockout position on the 5-position control pad on the console. It is a rather simple job to remove the outer "shell" from the switch and snap it into the blank position on the pad. (We now have) a revised Installation Sheet reflecting some of these points.

From a general interest standpoint, we shipped an armrest to one of your readers in Japan!

Richard P. Husta, President
Husco Engineering Company, Inc.
Wilton, CT

It may be SAAB terrain, but it isn't SAAB country

Back in July, I was towing the Vintage Racing Group 1960 SAAB #93 back to Maryland from South Carolina so I could take it to the convention in Sturbridge. It wasn't quite dark when I crossed from North Carolina into Virginia on I-77 and began to look for a place to get a cup of coffee. Just after the intersection with the Blue Ridge Parkway, I saw a gas/convenience store at the Fancy Gap exit. This is kind of right up there in the Blue Ridge Mountains; the map shows Beamer Knob, elevation 3,361 ft., right beside the exit.

It so happens that I was wearing one of Jack Baxter's FTC Motorsports Atlanta "MADE IN TROLLHÄTTAN BY TROLLS" T-shirts with the big troll on the front. As the girl behind the counter was ringing up my coffee tab, I could see she was reading my T-shirt. I chuckled and said, "I suppose you're wondering what's made in Trollhattan by trolls?" She said "No," but I chided her, saying I wouldn't want to leave

her in suspense; that SAABs were made in Trollhattan by trolls.

Her response was "What's a SAAB?"

I said SAABs were automobiles like the old one on the trailer, motioning outside. She looked out at the 93 and turning back to me said, "That sure is the ugliest car I ever saw."

I laughed and told her, "That's what a lot of people say, but that's also why we love them!"

How does the old song go?: "In the Blue Ridge Mountains of Virginia, on the trail of the lonesome pine..." The trail, at least in the vicinity of Fancy Gap, must not be frequently traveled by SAABers. The

coffee did last me about another 125 miles until I had to stop for gas and dinner off I-81 in Lexington, Virginia. At least during that stop, the driver of a beautiful Peterbilt commented that I sure had a good looking car on that trailer!

I think I'll make it a point to stop for coffee in Fancy Gap when I take the 93 to Road Atlanta in October. SAAB needs exposure there, even if it is 30 years late.

Tom Cox
Woodstock, MD

LeMans Information

As you remember, The Factory originally announced its plans to compete in this most famous of all races this year. Unfortunately, taking over the floundering auto giant required shelving that idea. Naturally, the organisers were frantic that the race would have to be cancelled without The Factory's participation. In the end they managed to patch together a race of sorts and the event went off on schedule. The public too, fully expecting to see The Factory walk away with this year's race, was disappointed. The source hinted that a number of private groups offered to run this year, "unofficially", with The Factory's backing, and had to be turned down due to the size of the new North American commitments.

Naturally, with things coming right so quickly with the auto giant it was hoped that it would be only a one year delay. Happily this is now a fact as the full Board decided at its meeting last month. So it's on for next year!! This is expected to be announced shortly and will certainly satisfy the eager fans and prevent any threat to the famous race.

With all that has happened and the extra year it is natural enough to expect that the LeMans project has been refocused. In addition, some changes have been made to please the LeMans organisers' expectations and guarantee the crowds a good race.

It now looks like a three car team. There will be two Monte Carlos and a 95 Triple Turbo. If the necessary production target (200) of the new Sonneetts can be produced in time, the mix will be a Sonneett, a Monte Carlo and the 95 Triple Turbo. This would really give the crowd a thrill!! Imagine these three exotics screaming along, turbos winding, drivers shifting their nine ratios. Each being willed on by its own group of fans and supporters as they flash down the Mulsanne Straight at speeds approaching 105 miles and hour. A one, two, three finish is a certainty, but what order? It is a dream come true!!

Next time, another possible takeover. Until then, best wishes.

Simon Du Stroke

412-238-0900, Parts line
412-238-0099, Fax line



DENNIS SWEENEY
ROAD TESTED SAAB PARTS
RD 1, Box 410,
Ligonier, PA 15658

Buying SAAB parts cars and late-
model rebuilders every month.

- Computerized inventory -
Same day shipping on most items.

Used mechanical and electrical parts,
interiors, accessories, sheet metal,
rebuilt steering racks, wheels, heads,
transmissions.

Doktor Nio's SAAB Klinik

Submit your questions with as complete information on the problem as possible, also giving the year and model of SAAB. Problems of general interest will be answered here. No requests for personal replies please. Questions which would require modification of, or would defeat Federally required emissions systems will not be answered. For a proper diagnosis, it is recommended that you contact an authorized SAAB dealer or repair shop.

Send your questions to: SAAB KLINIK, 2416 London Road, Unit 900, Duluth, MN 55812-2221

I have owned a 1987 9000S for exactly three years and it has about 68,000 miles on it. My mechanic says that I have leaking crankshaft seals and leaking gaskets in the oil pan and oil filter housing. I also have a stretched timing chain. Are there any aftermarket parts that would last longer than OEM? Should I replace the chain tensioner with a post-1988 version?

Jeff Hubbs
Macon, GA

I was under the impression that the Value Retention Program for early 9000 models included resealing various engine joints. The oil pan does not even use a gasket but is sealed with silicone joint compound. Check the crankcase ventilating system and insure that it has a slight vacuum before replacing seals, and if you must replace them, stick with OEM parts.

The late version of the #7585086 chain tensioner has a finer ratchet and will quiet the chain rattle at idle.

Is there a quick-fit outer CV boot replacement for my '72 95?

Jana Walker
Yosemite, CA

I don't know of any aftermarket quick fit boots made expressly for the V4 cars. You may want to check with a VW or other imported parts supplier to see if there is something that would fit.

Recently I took my 9000 Turbo to a quick oil change outlet. The sign guaranteeing a 15 minute oil change made me think that since all they do is change oil, they must know what they're doing. They used Valvoline, my choice.

After the crankcase was drained, the new oil was pumped from an unmarked hose. Repeated questions as to the exact grade of oil yielded different responses. An extra quart was put in. Then the coil wire was grounded and I was told to run the starter for 45 seconds.

What happens if I have the wrong grade or wrong weight oil? At what point does excess oil hurt and what does it do? Is

it a good idea to run the starter with the coil grounded?

Lex duPont
Los Angeles, CA

"Quick Lubes", UGH! There is not enough room on this page to even begin sharing the horror stories from Saab owners who have visited these establishments. To answer your questions: A heavier than recommended oil may be slow to reach critical areas of the engine after a cold start. A low grade could clog the turbo unit by coking from the heat and blocking oil galleys.

Running the starter after refilling the crankcase can reduce engine and turbo wear by pre-lubing the system.

What kind of oil (grade/viscosity) should I use with the reuseable K/N air filter in my 99? What do you think of mixing Tufoil and Mobil-1?

My '87 9000 has had the following problems, are there fixes?

Water leaks through the sunroof only when the car is parked. Interior door handles cracked (all four doors!). Dashboard noise, front panel and driver side.

Joel Soumagne
Caluire, France

Your K/N air filter should come with a supply of oil and cleaner. The manufacturer claims you need not clean and re-oil for 50,000 miles!

I have no idea about the compatibility of these two lubricants. I have seen seal problems with the use of Mobil-1 oil. (Ed. Note: Additives for mineral oils are NOT recommended for use in synthetics.)

Our experience with leaking 9000 sunroofs has been with the glass-to-frame caulking. Run a bead of clear or black silicone around the glass-to-metal frame joint.

Yes, the cracking door handles seem to be common on the 9000. I have no cause or cure. Anyone else?

Dash board creaks can be quieted by removing the top panel, lubricating all the contact points, and reinstalling it. Later models have added attachment hardware.

I have three problems with my '81 900 Turbo (95,000 miles):

When the engine is cold and the RPM is less than 1500, there is a very loud chirping sound that is affected by turning the steering wheel or tapping the throttle. I have replaced all three belts and the water pump, but the noise persists.

Second, when I am making a very sharp low speed turn, there is often a clunk at the front end. I have had all the wheels off and put a wrench to all the suspension nuts and bolts. The best alignment shop in the area said the power steering bolts were loose, but that wasn't the problem.

Third, after driving the car and shutting off the engine, if I try to restart the car within two or three minutes, nothing happens when I put the key to the start position. I've learned to open the hood to let things cool and wait about five minutes, then the car will restart.

Charles Sayle
San Mateo, CA

The cold "chirping" you hear may simply be the alternator/water pump drive belt. The early H engine single drive belt is notorious for slipping due to the limited pulley contact area. Use a cogged belt and be sure the alternator mounts are intact. The pulley grooves can be deglazed by applying coarse rubbing compound on the belt and running the engine.

As far as your front end clunk, the front hubs are probably the source. We've found that the shifting of the wheel bearings in the spindle will cause a cracking sound on sharp low-speed turns. Also inspect the axle and drive hub splines for wear.

The hot starting problem may be the starter itself. Check for current with a test light as the switch is turned to the start position. If the lamp lights, there's an open circuit in the solenoid or the motor. Turbo starters suffer from the extreme heat of the exhaust which is one reason they've been relocated topside. The other reason is accessibility, which you'll discover when you try to replace yours.

Continued on next page

Recently I noticed that when operating the AC on my '84 900 Turbo that cooled air was generated through the center vents, but I could fry eggs with the air coming from the side vents. Even when closing the side vents, the air permitted through the defrost slits was enough to overcome the cooled air through the center vents.

Another recently corrected problem was with the windshield wipers. While driving through a typical summer afternoon thunderstorm I was astonished when the drivers side wiper ceased to function while the passenger side continued to swish along. In looking at the wiper I spotted a small pulley with a steel cable wrapped around it and connected to an arm. Looking back, if I had pushed the pulley back onto the splined shaft of the wiper arm, I would be richer today. However, in my attempt to get a good look at this Swedish engineering marvel, I knocked the cable out of the grooves in the pulley and, try as I might, could not get the cable back into the grooves. The new wiper arm, cable and pulley assembly was \$200!

Chris Hyche
Montgomery, AL

You are experiencing a heater valve that refuses to fully turn off. The old metal body heater valves leak hot water into the heater core and cause some heat all the time. Your center dash vent does not come through the heater box and your side vents never fully close because there is always a positive air flow through your SAAB's interior. The solution is to replace your heater valve with the newer plastic body style.

The windshield wiper mechanism in 900s are direct drive on the passenger side and cable driven on the drivers side. The drive cam on the drivers side is splined on to the shaft and it sometimes comes off. It is definitely the weak point of the system. You can't fix the unit in the car, but if you have all the parts and are strong of heart and smart in mechanical ways, you can re-attach the cam to the shaft with Loctite and correctly wind the cable, out of the car. If not, you should be able to find a reputable independent garage that could rebuild the unit for much less than the cost of a new one.

I have an '88 9000 Turbo 5-speed. Often, but not always, there is a noise (like a squeal) in the transmission as the clutch engages into first gear. It seems to happen more frequently under load (going up an incline or with several passengers).

The dealer says he can't hear it, and has not addressed the problem. On one occasion I drove the car for him, and could not make the noise appear; then on my way home it happened again. Any suggestions?

Mel Meer
New York, NY

Clutch engagement squeal has been noticed in 900 models but I've not witnessed the same sound in the 9000. It has to do with the material the clutch disc is made of and the noise is harmless. Has your dealer driven the car with the same load in it as when you've experienced the noise?

I recently installed Saab's APC Tuning Kit (red box) in my '88 9000T with A/T. I didn't get much improvement over the standard APC! Should the boost gauge go into the red zone with the Tuning Kit? (I had an '85 SPG with PVE's modified APC unit and it went far into the red zone, a rocket!) Is the A/T having an effect on the boost? shifting too soon? Will a sport exhaust system improve the performance?

Mark Riley
Hanover, MA

Maximum boost levels will vary with temperature, fuel grades and general engine "state of tune". Saab's APC box will be a bit more conservative in controlling boost compared to PVE's. Saab does indeed recommend the sport muffler P/N 02 74 639 in conjunction with the "red" control unit. Be sure ignition systems are set at spec and pressure retard/vacuum advance is working properly. Colder plugs may help as well.

The battery in my 1988,9000 Turbo failed last December in a month-long cold spell. I had to replace it with a specially made battery available only through a dealership, apparently because of special size requirements.

Can a larger battery be fitted?

John D. States, MD
Rochester, NY

Any Interstate group 42 battery should work in your 9000. The Megatron should be more than adequate. Be certain the accessory drive belt is not slipping over the alternator pulley. The harder the alternator works the higher the drive resistance is and the belt could be slipping without you hearing it.

I own a 1986 9000 Turbo with 55,000 miles. It has the Grey leather interior. I have noticed a wear pattern consisting of hundreds of tiny cracks in the outer surface

of the leather, particularly on the outer side bolsters. I have used the Saab conditioner once or twice a year. Is there any way to hide the cracks?

John Tiefenthaler
Brookfield, WI

There is a problem with premature wear in leather upholstery, especially the Buffalo Grey leather. Many squabs were replaced under warranty they wore so quickly. Contact a reputable upholstery firm and find out if re-dyeing would help.

A year ago I noticed that my left front tire had an unusual wear band on the outer part of the tread. The steering also drifted left and the steering wheel felt "heavy" to the left. I bought new P6's and had the front end checked. The alignment mechanic said the alignment was good, but took out a shim to compensate for the left pull. It helped but something was still wrong. The steering wheel still does not want to "center" like I remember it doing before.

Alan Bellinoff
Virginia Beach, VA

I venture to say there is more than one problem to remedy your 900's steering difficulty. If camber, castor and toe are within factory specs, raise the castor to 2°-2½° positive to regain some self centering. The rack may be at fault and the assist you receive might not be equal right to left. Take the power steering pump belt off, then drive the car at speed and feel the response. If it feels more equal, the rack should be rebuilt or replaced.

In your column you have recommended using a Mann oil filter W920/26 (for Turbo models). The parts store I normally shop at recommended a W920/12 and said they did not show a W920/26 for my '85 900 Turbo. I also have two W920/21s from a previous SAAB. What is the difference between the /12, /21 and /26?

Frederick T. Cullen
Schenectady, NY

Mann builds the various filters to meet individual engine manufacturers specific requirements and tolerances. The Mann W920/12 is made for Volvo and the /26 is made under Saab's specifications. The /21 seems to be a less expensive "covers more than one application" filter. Mann's cost for the Saab /26 filter is fifty cents more than Volvo's /12. Incidentally, Mann has stopped producing the W920/26 filter in blue at Saab's request. They are now black.

SERVICE SUBJECTS



FROM SAAB

900 Door Glass Scratching

Application: 900 models
 P.S.I. 06/90-0006, A-8/P.2
 Supersedes S.I. 03/89-1123 (May 1989, p.6)

Due to manufacturing tolerances in the door, the possibility exists that the outer door glass seal retaining clips could contact the window when the window is lowered or raised. This contact could cause scratches in the window. This problem is most prevalent on 3-door and Convertible models because of the shape of the glass and the space available within the door. The scratches occur when the window presses hard against the door glass seal and pushes the rubber lip of the seal over the top of the retaining clip, or when the clip cuts through the seal.

A new retaining clip, P/N 40 94 082, is now available to prevent cases of window glass scratching. This clip was introduced as a running change into 1990 production at the following VIN's: L3005686-, L5001305-, L7013007- (SN, CK) and L7012456 (CV). The new clip has a revised profile that eliminates the need to grind off the protruding edge as presented in S.I. 03/89-1123 (May 1989 issue, pg. 6).

The old design clip, P/N 82 78 947, is still available from spare parts inventories, however, this clip must only be used to retain the seal on the inside of the window.

For convertible models, a new inner window seal is now available which will also reduce the chance of the clip scratching the window. The new seal, P/N 69 96 821, is similar in design to the outer window seal and exerts less pressure against the window. This seal may be used on all Convertibles and supersedes the previous seal.

Parts Required:

Retainer Clip 40 94 082

Repair Procedure

1. Before installing the replacement glass, carefully inspect the door glass seal for

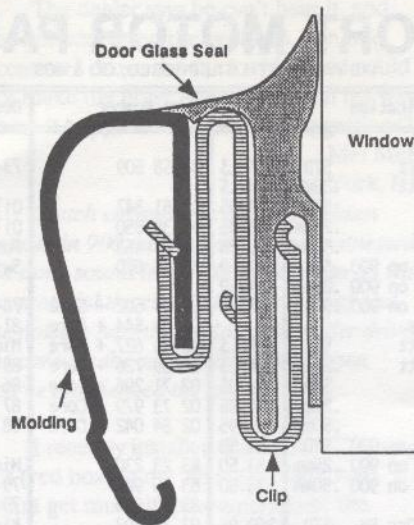

Figure 2. Cross section showing correct assembly of door glass seal molding.

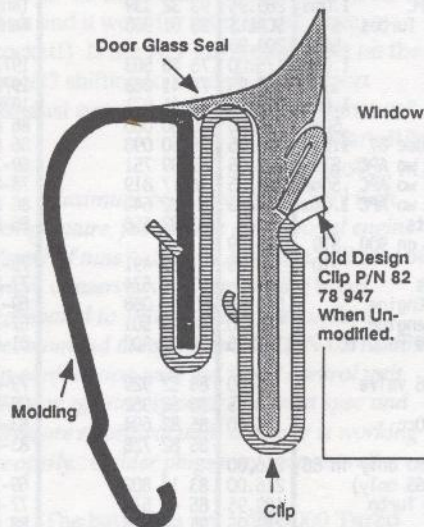

Figure 3. Incorrect assembly of door glass seal molding.

1. damage caused by the old clips. Replace the seal if necessary.
2. Remove the seal together with the molding. Carefully separate the seal from the molding.
3. Remove all the retainer clips and replace them with the new clips, P/N 40 94 082.
4. Install the molding on the door.
5. Insert the door glass seal onto the retainer clips.

NOTE:

The seal must be positioned so that the rubber lip is not bunched up, exposing the retainer clips (Figures 2 and 3).

6. Complete installation of the door glass.

Recall 278	ELECTRICAL OVERHEATING IN CENTER CONSOLE
	Safety-related 1986-90 9000 with A/T NHTSA 90v-001

Recall 278 (Revised) Overheating of Back-Up Light Switch

P.S.I. 06/90-0010, A-9/P.1
 Supersedes 03/90-1226 (May 1990, pg. 6)
 Saab Cars USA, Inc. has notified the National Highway Traffic Safety Administration (NHTSA) that a defect which relates to motor vehicle safety may exist in certain 1986 through early 1990 9000 models with automatic transmissions. Approximately 24,000 vehicles are affected.

The defect consists of the possibility that the combination neutral safety/back-up light switch may overheat from the current flow through the back-up lamp circuit when the ignition is switched on and the automatic transmission selector is in the Reverse (R) position for long periods of time. If overheating of the switch assembly does occur, smoke or, possibly, fire could develop in the center console area of the passenger compartment.

These cars are being recalled to modify the back-up light wiring circuit to reduce the maximum electrical current flow through the neutral safety/back-up switch, and to replace the switch.

Vehicles affected by this Recall:

1986 through mid-1990 9000S, Turbo and CD Turbo models with automatic transmission as follows:
 VIN G1000001-L1011813
 VIN H2000001-L2008735

This PSI includes revised and additional repair procedures that were not specified in S.I. 03/90-1226. These procedures are:

- The neutral safety switch should be **replaced** instead of inspected.
- There is a revised location for the placement of the eight-pin connector that is part of the modification wiring harness.
- The routing of the wiring harness that leads to the eight-pin connector has been changed on 1986-89 cars.

Saab Service Information updates are provided to NINES as a courtesy to Saab owners by Daniel David, Director, Service and Technical, and Sten O. Helling, President of Saab Cars USA, Inc.

More power to ya' in '91

It's less than a year since Saab-Scania AB joined forces with General Motors (Europe) AG to produce Saab cars. The changes for the 1991 model year are subtle, but emphasize the continuing evolution of the current Saab 900 and 9000. New engines in both lines, a more diverse lineup of 9000s, and a longer warranty highlight the new models.

9000 Repositioned

The 900's younger sibling, the 9000, sees several changes pertaining to marketing for its sixth season. The 9000S 4-door has been rebadged as the 9000 CD, with the turbocharged version labeled the 9000 CD Turbo. The 5-door Turbo becomes more sporty while the CD Turbo is more luxurious. Both Turbos will benefit from the larger 2.3 liter engine (called the B234), rated at 200 hp for the U.S. market.

In addition, a new base 9000 will make an appearance. It will have the naturally-aspirated 2.3 liter engine, but will be a bit more spartan than the other 9000s. Fabric upholstery and steel wheels will be standard; deleted are such fripperies as the power steel sunroof and cruise control. Priced at \$22,895, it will be available as a 5-door model only.

The 9000 Turbo leans further into the "sports sedan" category with new 6½" by 16" 3-spoke alloy wheels shod with Pirelli P700, 205/50 ZR 16 tires sticking the car to the ground.

Solid color models (Talladega Red, Cirrus White, and Black) will have color-keyed bumpers. Other body colors get the Anthracite Grey bumpers. Black trim is added around the windows and wheel arches. A larger, oval-shaped exhaust pipe gives the Turbo a throatier note.

All 5-doors will now have the same front end as the 9000 4-door models, which includes the headlight wiper/washers, slanted grille and bumper system.

Saab's 4-speed automatic transmission will be standard on the 4-door 9000 models, with the 5-speed manual as an option. The automatic has also been reinforced to withstand the increased torque of the 2.3 liter turbo engine.

Burled English Walnut is inlaid in the dash, shift surround, and storage compartment lid on the CD Turbo, and a compact disc player is standard, replacing the EQ. Also new, a rear decor panel and dual power seats. Suggested list for the top-of-the-line 9000 is \$33,995.

Leather upholstery and fog lights are standard equipment on all but the base 9000. The S, CD and Turbo models come with new 15", 15-spoke alloy wheels. They look similar to the

current 15-spoke wheel, but the spokes have been recessed at the rim to reduce weight and improve rim flex.

All 9000s get improved noise dampening, and reinforcements in the side structure for better lateral collision protection.

The turbocharged version of the B234 engine is the big underhood news for '91. Horsepower rating is 200 at 5,000



Smoother gearshifting is one of the upgrades on the 900.

rpm, with maximum torque of 244 ft. lbs. at 2,000 rpm (222 ft. lbs. with the automatic). *Car and Driver* magazine has reportedly achieved a 0 to 60 time of 6.4 seconds with a 9000 Turbo (5-door, 5-speed), making it one of the quickest cars sold in America.

2.1L engine for 900

The big news in the 900 lineup is a larger engine -- 2.1 liters (2119cc or 129 cu. in.) -- for the base and S models. The enlarged 16 valve powerplant puts out 140 horsepower (up 12 from the 2.0 liter), and provides 6 percent more torque -- 133 lb. ft. at 2900 rpm. The engine for turbocharged 900s remains the same -- 2.0 liters (1985cc or 121 cu. in.) -- with 160 hp for the Turbo and Convertible, 175 hp for the SPG.

The 5-speed gearbox has been reworked for better synchronization and smoother shifting.

A headlight wiper/washer system has been developed for U.S. spec headlights and will be standard equipment on all 900s. Daytime running lights (as required in Europe and other markets) will be an option.

Inside, the 9000 seats and seatbelt anchorages will be standard on the 900 series. The new seats offer more adjustment possibilities. The seatbelt anchoring point is moved up and forward for increased safety in case of collision.

The 900 Convertible gets dual power seats as standard equipment, and the volume of the trunk is increased by about



A new 16" wheel for the 9000 Turbo (5-door).

New Models - Continued on page 12

Saab 2.3 Turbo: New engine with unique combination of economy and performance

An entirely new turbo engine from Saab is one of the most noteworthy items of news in the 1991 range of Saab models. Six years of development work lay behind the new engine, which was launched in its injection version just one year ago.

Although the 200 bhp of the new 2.3 litre Turbo engine are good for a top speed of 144 mph, mid-range performance is the truly unique attribute - the sprint from 80 to 120 km/h (50 to 75 mph) in top gear takes a mere 7.8 seconds.

Due to turbocharging technology, engineers can achieve the good normal-motoring fuel economy of a moderately-sized engine, combined with supercar performance whenever the need arises. While delivering a peak torque of 244 ft. lbs. (222 ft. lbs with the automatic) and an output of 200 bhp, the turbocharged 2.3 litre engine from Saab has an Environmental Protection Agency (EPA) fuel economy rating of 19 mpg City, 25 mpg Highway.

The new Saab engine has a swept volume of 2.3 litres and is equipped with two balancing shafts, four valves per cylinder and double overhead camshafts with hydraulic cam followers. It also features the unique Saab Automatic Performance Control (APC) system that

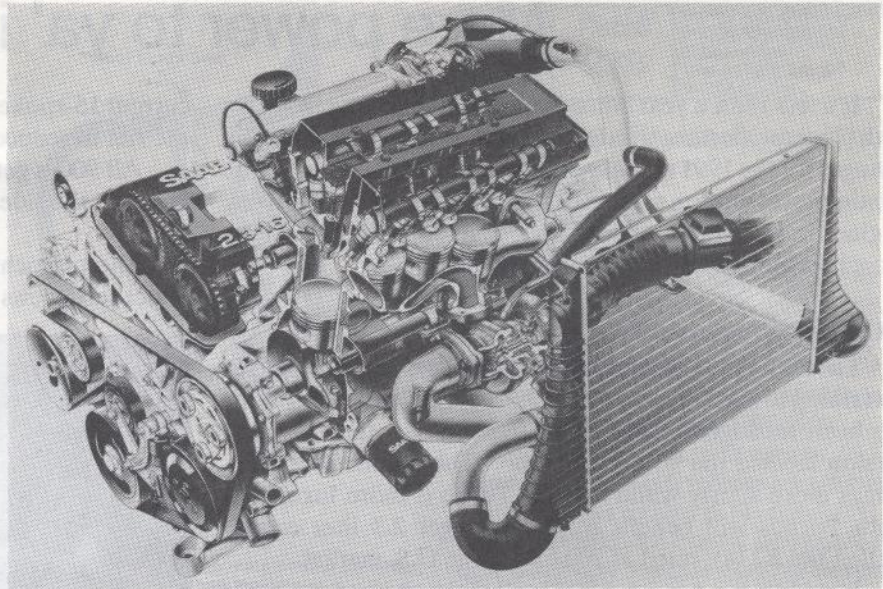

prevents knocking by adjusting the turbo boost to accommodate even very wide variations in the fuel quality, and the highly efficient Saab Direct Ignition (DI) system.

The engine is also equipped with the Saab climate-related emission control system that reduces exhaust emission by up to 50 percent when the engine is started from cold (up to 80 percent if combined with an electric engine heater).

Engine part of the overall concept

Instead of regarding the engine as a separate entity, Saab has always considered

it part of the overall car concept and an essential ingredient for optimum balance between factors such as interior space, weight, road behavior, safety, performance and economy.

Towards this end, Saab is dedicated to front-wheel drive and an engine/gearbox unit that encroaches as little as possible on interior space. At a given level of performance, a compact power unit is lighter than a large engine, which is essential for achieving good overall balance and fuel economy, combined with a high standard of performance.

Four cylinders, 2.3 litres and balancing shafts

The new four-cylinder turbo engine from Saab has a swept volume of 2290cc and is of "square" design, with the bore and stroke both 90 mm. The light-alloy cylinder head is a further development of the well known Saab head, with two overhead camshafts and four valves per cylinder.

The cast iron cylinder block is of slender design, but with no compromises on very high rigidity and excellent vibration-damping properties.

Although vibrations are generated in all internal combustion engines, they are virtually eliminated on the new Saab engine by the two balancing shafts integrated into the engine block. These shafts are fitted with counterweights and rotate in opposite directions at twice the crankshaft speed.

The higher power output achieved by turbocharging the Saab 2.3-litre engine

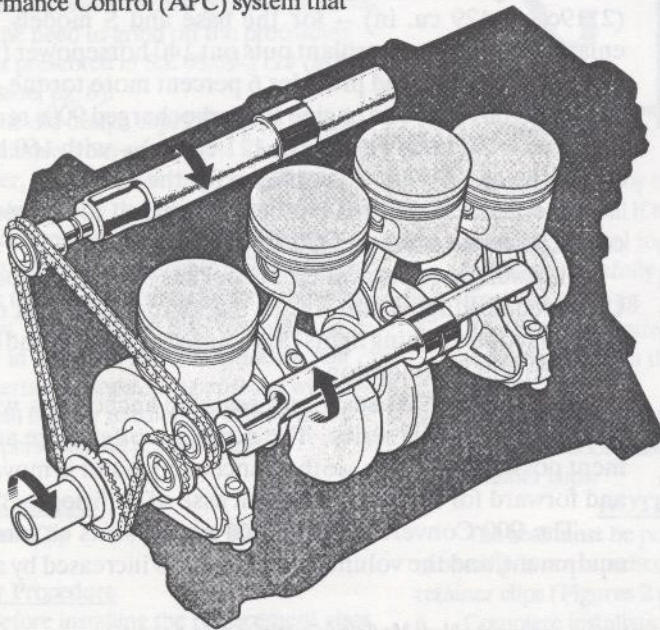

Saab's 2.3 liter engine uses counter rotating balance shafts to eliminate internal vibration.

makes it essential to control the engine temperature reliably and efficiently. This is achieved by equipping the car with a larger engine oil cooler and by providing a special oil cooling arrangement for the pistons.

Oil is delivered through oilways in the engine block to a separate valve and nozzle fitted at the bottom of each cylinder liner. The nozzle sprays oil into the undersides of the pistons, and the heat absorbed by the oil is dissipated in the oil cooler.

Oil cooling of the pistons has long been successfully employed on the diesel engines manufactured by the Scania Division of Saab-Scania. But Saab is among the pioneers in introducing this reliability-boosting feature on gasoline engines.

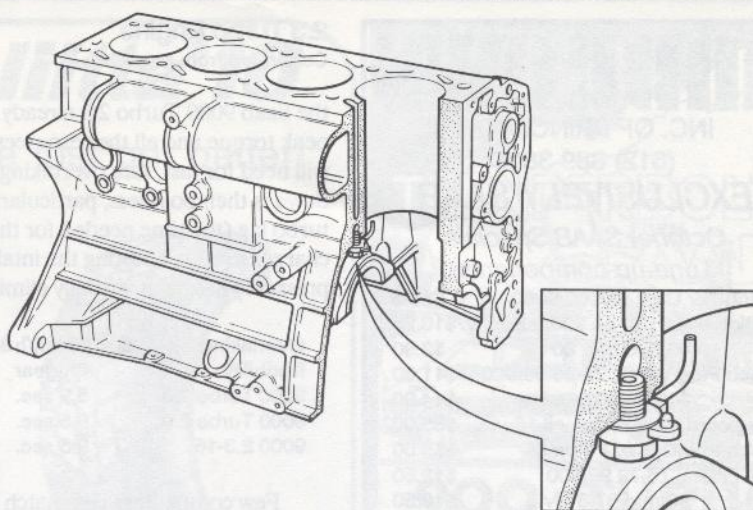

A nozzle sprays oil to the underside of each piston for extra cooling.

High performance...

The new 2.3 litre turbo engine from Saab is rated at 200 bhp at 5000 RPM. But the more impressive aspect of its performance is the peak torque of 244 ft. lbs. at a mere 2000 RPM. At only 1750 RPM, the engine already develops 222 ft. lbs., and the torque curve is very flat above 2000 RPM.

... for comfortable motoring and fast, safe overtaking...

The engine torque is more important to performance than the horsepower rating. While the horsepower merely determines the top speed of the car in a given gear, the torque is decisive to the flexibility of the engine/car combination during overtaking and in other critical situations.

The high and uniform torque from low speeds up to the higher reaches of the range offers two benefits to the driver - reduced gear-changing work and safer overtaking.

... without changing down...

Reduced need for constant gear changing up and down in city traffic improves driving comfort and also allows the driver to devote more of his attention to the surrounding traffic.

The growing body of expert opinion is assigning less importance to high peak engine power and dramatic acceleration from rest. The emphasis now is on mid-range performance. Acceleration for 60 to 100 km/h (37.5 to 62.5 mph) and from 80 to 120 km/h (50 to 75 mph) is of greater benefit to practical motoring and active safety.

At 50 mph in top gear, the engine of
Continued on page 12

Saab 2.3 Turbo

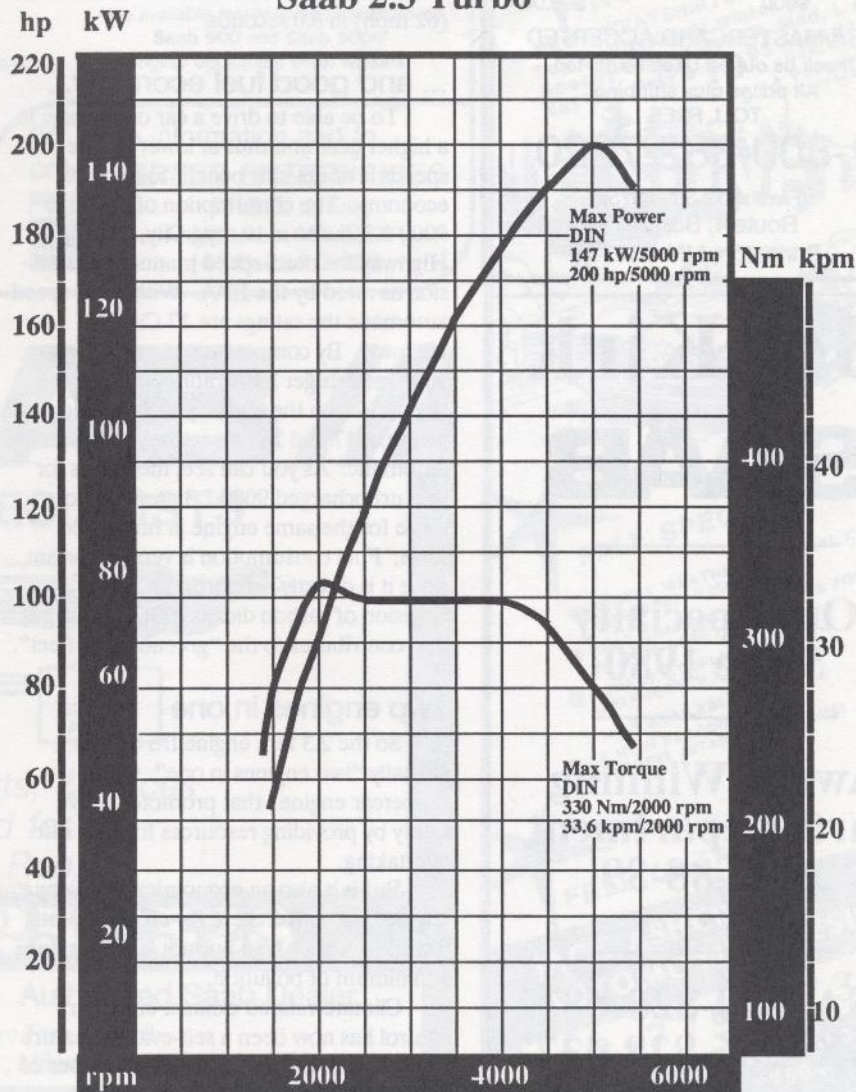

The horsepower and torque curves of the Saab 2.3 Turbo

ANDREWS

INC. OF PRINCETON

(612) 389-3805

EXCLUSIVELY SAAB

October SAAB Specials

Tune-up components

Distributor Cap, 99/900/9000	\$5.85
Ignition Rotor, 82-on 900, all 8 vlv.	\$10.25
99/900 thru 80	\$2.90
Bosch Plug Wires, 74-80 99/900	\$11.00
81-87 900 8-valve	\$14.00
Bougicord Plug Wires, all 16 vlv.	\$55.00
Bosch Points, mid 74-on 99	\$5.00
Fuel Filters, 75-79 99/900	\$12.50
80-mid 87 8 vlv.	\$16.50
900/9000 16 vlv.	\$16.50
Headlamp covers, 900/9000	\$45.00 pr
Thermoplastic floor mats, 900	\$68.00/4
9000	\$90.00/4

VISA/MASTERCARD ACCEPTED

Check us out on Used Parts, too.

All prices plus shipping

TOLL FREE

1-800-882-7220

(Fax#: 612-389-3875)

Route 4, Box 247

Princeton, MN 55371

Bel-Kirk SAAB

Our Specialty
Since 1980

Award Winning
Parts Department
1987-88-89

USA 800-828-6812
FAX 206-828-4272
Local 206-828-4511

2.3 Turbo Engine

Continued from page 11

the Saab 9000 Turbo 2.3 already delivers peak torque and all the resources the driver will need for fast, safe overtaking. Changing down is then pointless, particularly since turbo lag (the time needed for the turbo-charger to start boosting the intake air pressure) has been virtually eliminated.

Overtaking flexibility	60-100 km/h	80-120 km/h
	4th gear	top gear
9000 Turbo 2.3	5.9 sec.	7.8 sec.
9000 Turbo 2.0	8.5 sec.	11.5 sec.
9000 2.3-16	9.5 sec.	14.5 sec.

Few competitors can match these values, whatever the engine size and rating.

As a matter of interest, a Saab 9000 Turbo 2.3 accelerates from rest to 100 km/h (62 mph) in 8.0 seconds.

... and good fuel economy...

To be able to drive a car on average in a higher gear and thus at lower engine speeds is of obvious benefit to the fuel economy. The consumption of the Saab 9000 2.3 Turbo is 19 mpg City, 25 mpg Highway for the 5-speed manual transmission as rated by the EPA. With the 4-speed automatic the ratings are 17 City, 24 Highway. By comparison, the non-turbo 9000 models get EPA ratings of 20 in the city and 26 on the highway with the manual gearbox, 17 and 25 respectively with the automatic. As you can see, the values for the turbocharged 9000 2.3 are very close to those for the same engine in non-turbo form. Fuel consumption is very important, since it is directly proportional to the emission of carbon dioxide (CO₂) - the gas that contributes to the "greenhouse effect".

Two engines in one

So the 2.3 litre engine fro Saab is virtually "two engines in one". It's a "supercar engine" that promotes active safety by providing resources for fast, safe overtaking.

But it is also an economical everyday engine that converts energy efficiently into transport work. Last but not least, it causes a minimum of pollution.

Climate-related exhaust emission control has now been a self-evident feature of Saab four-valve engines for a number of years. This system enables the catalytic converter to become effective much quicker

after starting from cold. under typical Swedish climatic and motoring conditions, a Saab car with climate-related emission control emits up to 50 percent less harmful pollutants than a car with a conventional catalytic converter.

This is achieved by factors such as fast preheating of the catalytic converter and early activation of the oxygen sensor (Lambda sensor).

To some extent, turbocharging technology is also behind the climate-related emission control system.

"We have great faith in the turbo engine," says Per Gillbrand, Saab's chief engine designer. "A turbocharged engine is more compact, lighter and more economical on fuel than other engines with comparable performance. Its emissions are also easier to control than those of conventional injection engines."

"The new 2.3-litre engine delivers 30 percent more power and 50 percent more torque than an injection engine with the same swept volume. But it still involves 25-30 percent less laboratory work for exhaust emission and noise certification."

What's more," continues Gillbrand, "the turbo engine emits 15 to 20 percent less hydrocarbons, and 20 to 30 percent less nitrogen oxides than a naturally-aspirated engine of equivalent power."

"Finally, the silencing effect of the turbocharger is a bonus the owner gets into the bargain."

New Models

Continued from page 9

10 percent. The open-top Saab also gets a new alarm system, made by Alpine.

The 4-door version of the 900 Turbo is being dropped.

Pricing will range from \$18,295 for the base 3-door 900 to \$33,295 for the Convertible.

Longer Warranty

All 1991 Saabs are backed by a new 6 year/80,000 miles limited warranty, with bumper-to-bumper coverage for 3 years/40,000 miles, and major system coverage for the duration of the warranty period.

All Saabs will continue to have anti-lock brakes and a driver's side air bag as standard equipment.



Hakkapeliitta® 10

The world's best snow tire just got better!

Hakka 10

- Three or four longitudinal grooves give stability in slush and snow.
- Low frequency zigzag of grooves gives driving comfort and stability in traffic grooves.
- Carefully designed, open sipes balance the grip in all directions cornering and driving.
- Special design of the pattern maintains excellent side grip.
- Special block pattern with Hakkapeliitta appearance.
- Directional pattern gives excellent behavior in slush and snow.

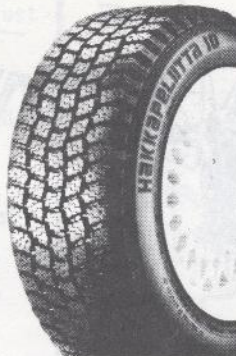

Also available mounted and balanced on Saab 900 and Saab 9000 original equipment steel wheels.

Tire studding available. **Lowest prices.**

SAFETY, PERFORMANCE and QUALITY from FINLAND

Now in stock for VINTAGE SAABS:
Nokia Lapponia 155SR-15
summer tires

For more information and to order: **GREER ENTERPRISES**



1810 E. Jarvis
Milwaukee, WI 53211
(414) 964-7463

SAAB

PARTS SPECIALISTS

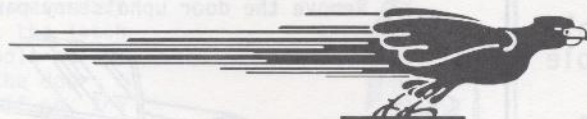

100%
GENUINE
PARTS

Service, Parts, & Prices
Designed for the
Long Run!

1-800-225-2528

Capitol Import Autos Authorized Saab Dealer

(formerly Jack Safo Tosa Imports)

9201 W. Brown Deer Rd., Milwaukee, WI 53224

THUNDERBOLT FROM SAAB



THE 900 TURBO

NOW AVAILABLE!

2 NEW SWEATSHIRTS!
Top quality. Great winter wear!
Specify 900 or Sonett, Med, L or
Ext L. Only \$19.95 Postpaid
USA, Canada \$24 Postpaid
Overseas

SONETT



FALL SPECIALS!

- SONETT WEATHERSTRIP SEAL KITS FOR DOORS, REAR HATCH!
- HEAT CONTROL VALVE KITS FOR 95, 96 & SONETTI
- SONETT STOPLIGHT SWITCH CHANGEOVER KITS!
- NOW AVAILABLE!
- V4 HIGH PERFORMANCE 2-BARREL INTAKE MANIFOLDS!

FREE CATALOG!
**JACK ASHCRAFT
AUTOMOTIVE DESIGN**

503-779-0731

2201 Woodlawn Drive
Medford, OR 97504



SHIFTIN' GEARS

by Jack Ashcraft

One of the things we do in our parts sales business is to provide a complete how-to-do-it step-by-step instruction sheet to show how to install the part or the kit we offer for sale. Once in a while I build myself into a corner. For example, in the installation instructions for Sonett door weatherstrip kits, I mentioned that you might have to readjust the door to fit the new weatherstrip, since the old stuff shrinks and gets out of shape with years of use.

It occurred to me that most owners probably never adjusted a Sonett door in their whole born days and that I had best make up a sheet on how to do that little task. Here is a reproduction of those instructions for those who might need help on such a task, even if they aren't changing weatherstrip.

DOOR ADJUSTMENT SAAB SONETT III

1 Remove top trim panel. Note which screws go where. Some may be longer than others. You don't want to screw them into the window glass when you put the door back together!

2 Remove the lock knob.

3 Remove the window winder screw, winder handle and plastic washer.

4 Slide back the plastic trim covers at the ends of the door pull and remove the 4 screws and the pull handle.

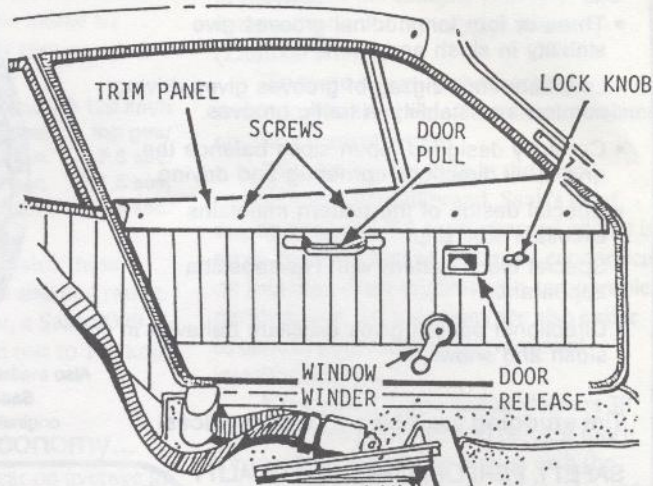

5 On '70-'72 Sonetts, remove the screw, door release handle and washer. On '73-'74 Sonetts, the Saab 99 style door release handle has a recessed cup that is held in place with a clip. Pull the handle (as if to open the door) and pull the front of the recessed cup outwards. The clip should release allowing you to remove the cup.

6 Use a flat blade screwdriver and pop loose the clips at the front & rear edges of the door upholstery. Pry as close to the clips as you can to minimize the chance of breaking the clips or the door upholstery panel. Remove the door upholstery panel.

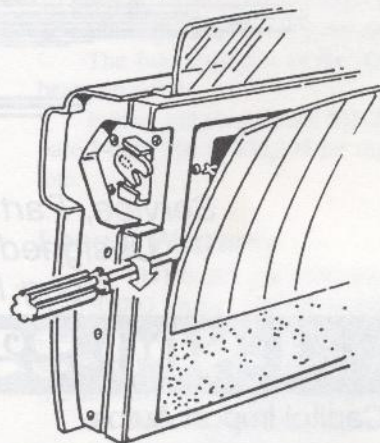

7 Collect the spring behind the window winder handle (inside the upholstery). Note that the large end of the spring faces the upholstery.

8 Loosen the TOP nut for the door hinge slightly (24mm or 15/16" socket and universal joint).

9 Push door out away from the body at the top. Re-tighten nut. Check fit first with window down, then up. Readjust as required.

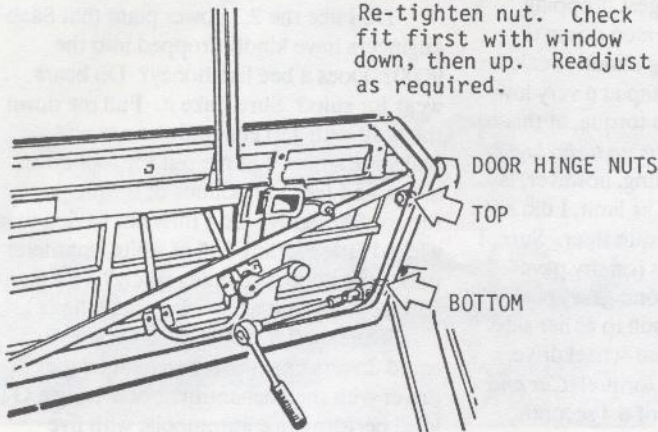

10 This is a good time to check the fit of the door at the rear. If it sags, you can loosen the outside top nut and tighten the inside nut to raise the back end of the door. Opposite to lower.

OUTSIDE NUT (A)

INSIDE NUT (B)

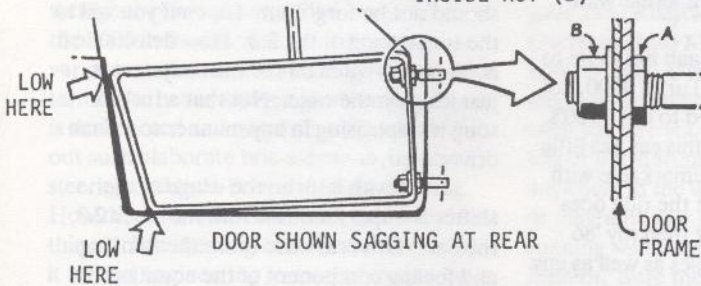

NOTE: It may be necessary to adjust the latch striker bolt at the back of the door opening. If so, the large screws can be loosened and then tightened again by using an impact screwdriver.

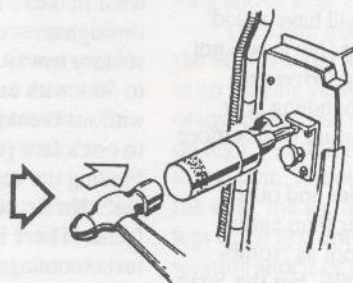

11 Lubricate all moving joints, ball channels for window lifts, etc.

12 Lube latch/lock mechanism.

13 Re-install the door upholstery and hardware.

SONETT LUG BOLT DATA

Several people have asked questions about Sonett lug bolts recently. Here is the information:

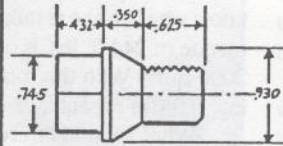

7061559 is for the early Sonetts, including the Sonett II two cycle and the V4s. Steel wheels.

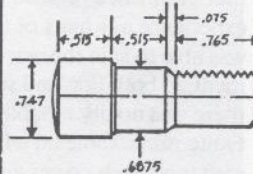

7421837 is for the early Sonett III mag wheel.

7423437 is for the late Sonett III mag wheel.

The bolt shown on the bottom is for the Ronal/Saab Rally wheel.

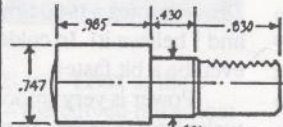

The important thing to remember here is that the steel wheel and the Ronal wheel have flanged holes drilled in the wheels (in the case of the steel wheel it is stamped in). The centering of the wheel about the circumference of the wheel bolt pattern is thus taken care of by the lug bolt screwing into place and self-centering the wheel.

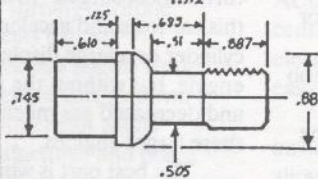

The lug bolts for the other mags rely on the shoulder of the lug bolt to do the centering. You will note that there is a difference in the shoulder diameter--.6875" for the early bolt and only .5720" for the later lug bolt.

The correct conclusion here is that the bolts should not be interchanged. Late bolts for late wheels, early bolts for early wheels. Using late bolts on the early wheels, for example, could allow the wheel to be displaced to one side and cause a pretty severe out-of-round condition to take place on that wheel, even though the tire and rim were in perfect balance.

Finally it is important to realize that the use of the wrong lug bolts can and may cause failure of the wheel itself, with attendant drama and danger to life and limb. It's best to use the right bolts.

Driving Impression:
1991 9000 2.3 Turbo

I recently had the opportunity to test drive the 1991 Saab 9000 2.3 liter Turbo. I drove the 5-door version, with sports suspension and low profile Pirelli P700's. As the owner of a 1986 9000 Turbo, with APC bump-up and sports exhaust, I still found the 2.3 liter Turbo to be remarkably superior to my '86.

This car looks visually different from earlier 9000s. No more chrome trim (except the front grille). It has been blacked out. The headlamps and front grille have been slanted back (like on the 9000 CD) giving the nose a more aerodynamic appearance. The exhaust (tail) pipe is huge and elliptical in shape. Very noticeable are the low profile 16-inch wheels mounted on 3-spoke alloys, somewhat like those on the 900 Turbo SPG. All these changes (along with a deeper and integrated front spoiler) give this car a very aggressive stance.

There are a number of minor interior changes such as a new (programmable) climate control, read-out display, shift knob and power seats... but who cares.

One of the best parts of this car is the throaty sound it makes when started - similar, but a bit deeper in pitch than the 900 Turbo. The 2.3 idles smoothly, and once underway, few vibrations are apparent

to driver and passenger. Pulling out into city traffic is no longer any concern for this next generation of turbo technology. There is no turbo lag! None!! Should any automotive reviewer in the coming months say otherwise, I would suggest dropping your subscription... that person doesn't know what he/she is talking about! Peak torque of 244 ft. lbs. is on tap at a very low 2000 rpm. With this much torque, at this low RPM, I repeat... *there is no turbo lag!*

What I found interesting, however, is that even when pressed to its limit, I did not experience any hints of torque steer. Sure, I was able to spin the wheels (on dry pavement, in both first and second gear) but there was no discernable pull to either side. Quite remarkable on a front-wheel drive with this much power and torque! *Car and Driver* quotes a 0-60 time of 6.4 seconds, and I believe it! In colder weather, it might even be a bit faster.

Power is very smooth with no sudden turbo boost surges. In almost every respect, this car feels and accelerates like an eight-cylinder or a large displacement six-cylinder engine, but without the penalties of weight and decreased gas mileage inherent with these larger engines.

The best part is what Saab has done to the handling of this 5-door Turbo 9000, not all of which can be attributed to the P700's. Under very hard cornering this car has little or no body roll, and more remarkable with these low profile tires is that the ride does not seem noticeably harsher than my '86 9000. It swallows up pot holes as well as any Saab I've ever been in, and that's saying a lot for a car that probably will have a skid pad score in excess of 0.85 g (my guess, not having seen the full *Car and Driver* test results). In any event, the handling now reflects the true sporting nature of this more muscular Swede.

Rigidity, squeaks, rattles and other annoyances are much better than earlier 9000s I've driven. It's still not as "tomb-like" as, say, a Mercedes 300E, but this Saab is damn close. All in all, this is a great car! Expensive, yes, but compared to its competition, the 2.3 liter 9000T is ahead in almost every category.

Bob Sinclair, if you're reading, for those of us who already own a 5-door 9000 and don't wish to duplicate, when are you going to give us this car in a coupe? I'd buy one in a minute!

Dr. G. M. Metzger
Gaithersburg, MD

Driving Impression:
2.3 9000 S --
A Saab sojourn
of the finest kind

Do I like the 2.3 power plant that Saab engineers have kindly dropped into the 9000? Does a bee like honey? Do bears wear fur suits? Sure I like it. Pull me down the road with 150 energetic horses and make me smile. Let me put my foot down in low and feel 157 pounds of torque grip the road hungrily. Do I miss not having that wicked little swirling ball of white-hot metal under the hood screaming wildly? Not completely. Why you ask? --Lemme tell you...

The new 2.3 16v with SDI is a dedicated drivers engine. It reacquaints the driver with the enchantment of driving a GT level performance automobile with five doors (eat *that*, Nissan). The driver is allowed to become part of the driving experience, not simply a pedal-pusher. Anyone can put their foot down and let a turbo or monstrous chunks of cubic inches do the work, but the lovely sensuous grace of using a well-matched engine & gearbox should not be forgotten. Listen if you will to the tuned song of the 2.3. How delectable it is. A little Vivaldi on the music system is just icing on the cake. Not that a turbo's song is displeasing in any manner to a Saab driver's ear.

Even with a turbo the usage of the shifter is important. But with the stock 2.3, the Saab Driver is once more the thinking and feeling component of the equation of what makes a motorcar move suavely through a set of sweet twisties on some solitary byway. Second gear pulls the 9000 to 50+ with ease and third finds 80+ without breaking a sweat, yet brings a smile to one's face (okay, abominable smirk). Finding the century mark and beyond (what me? No sir... heh-heh-heh) is effortless and facile. There isn't that sudden rush of a turbo coming to speed, but swiftly there you are just the same... entering the Twilight Zone. And then expeditiously remembering that some States use radar as a form of invisible taxation, back behind the "rabbit" in the pack you go. Let the rabbit get the ticket is my motto.

For those that prefer to let the transmission do the shifting for you, the ZF four speed automatic is now working with an engine in harmony. Less grunting and hunting than with the 2.0. Put your toe into

BOB YATES
IMPORT CAR SPECIALISTS
Clearance Sale!

- Gislaved Snows w/steel wheels \$125. ea
- 15x5 1/2 15-spoke take off wheels, '88 on 900/9000 \$125. ea
- 15x6 Cartech Gold 5-spoke alloys, all 9000 & '88-on 900 \$750./set
- Nevada Brown armrest, 9000 \$150.00
- Rocker panel trim kits, 9000CD \$99.00
- Bilstein R2000 Paint Sealant or Fabric Protector 2 for \$8.00
- Fold down armrest, 900 \$99.00

Call for more specials!

TOLL-FREE PARTS LINE
1-800-669-SAAB

Fax# 215/752-5614

Discount to SAAB Club members

Rt. 1 & I-95
Langhorne, PA 19047



the pedal and the transmission drops into third, where it is put to work gracefully and with a constant band of power.

Helping this new 2.3 engine fulfill its function are the excellent manners of the 9000 platform itself. The tires feel as though they are placed at the outer edges of the 9000 in four directions. Cornering in various conditions from loose gravel, to wet tarmac, to helter-skelter cambered sweepers is sure footed and very balanced. All without such elaborate bric-a-brac as 4-wheel steering and hula-hoops. Simply amazing. How do those darn Swedes at Saab do these things? Is it the long cold winters, or could it be that engineering instead of marketing is making the critical design decisions?

And speaking of attentive design, this is an exceptionally clean burning *Green* engine that treats the air we breath with as much kindness and consideration as possible. To me that is one of the most noteworthy aspects of the 2.3.

Speaking of design, let us not forget the satisfaction of driving with ABS brakes on command. ABS is a system that should be a must for road vehicles, especially on trucks and mini-vans with the variable loads they carry which tend to be heavier than autos. In the Saab line ABS is standard for some reason. Could it be safety? And speaking of safety, the one nice thing I can say about air bags... they rid cars of mice. I hate mice.

Now for the real treat. Open the hood. The 2.3 engine was designed for the 9000, not adapted. Look around... Could that be an oil filter in plain sight? An air-cleaner

that one can lay hands on? Look at the tuned intake system -- the curved horns that sing that magnificent throaty baritone melody when foot meets carpet.

This is one meticulous engine compartment. If you don't believe me, go down to your local Recycled American Metal Overseas Auto Manufacturer and pop a hood or two. Under those vacuum lines just might be an engine. But where? Really want to scare yourself? Look at the engine bay of a V-6 from the East. Do mechanics anywhere in the world have hands that small or diagrams that good? The mess of lines running wildly about is what I term *Spaghetti Eastern*. Sure they do the job, but for how long and at what cost?

The main item that I did not care for in the 9000 S is the leather seats. I realize that in an upscale vehicle, leather has become an obligatory accessory. But even with the AC on high, I find that my back and thighs stick to the seat. In hot sunny climates such as the west, the leather can rudely burn your legs when first entering a parked car if one is wearing shorts or dresses (some of you know how I like to wear dresses). In those conditions, the expensive leather reminds me all too much of cheap vinyl. I would prefer luxurious cloth seats as an option on the S/CD/Turbo.

One pleasant piece of news pertaining to the Automatic Climate Control (ACC) system in the S model... it ain't there. In it's place is the familiar rotary dial system such as on the 900. Included is a four speed fan. I like the ACC, but can live without it.

Skeptical still? I suggest you test drive the 2.3 9000. It is a Saab. Solid and safe with unique features. It is logical replacement for the 900 5-door that so many long for in this country. Inexpensive... No, but neither is your life. Think about that insignificant element when considering the bottom line. That element is something that none of us can live without.

Ashtrays are one item I could live without, nonetheless every car but a Bricklin has them.

Robin Williams said "...cocaine is God's way of saying that you have too much money." Then driving a Yugo must say just the opposite. Think of the reflective value placed on your life?

But for those of us still thinking about our flat green friend (\$) and how to keep our "friend" around the house longer, there is now a basic 9000 2.3 with all the assurance and amenities that Saab is known for, minus some of the whistles and bells such as ACC, sunroofs, electric seat controls, and central locking. (I should point out that the electric seat controls are well-placed and easy to use, even when not looking.)

One feature I would like to see included however is a delayed electric bus allowing for windows/sunroof to be opened/closed for a short time after the key is removed.

The electric thingamajigs and doodads are very gratifying amusements, but they do not make the 2.3 9000 what it really is -- a Drivers Machine... with five doors if you so desire. If you have any questions about the 2.3, please feel free to give me a call. I talk SAAB.

Paul Florance
Seal Beach, CA
(213) 493-6707

SAAB ACCESSORIES

K Y B Gas Shocks - set of 4
99 (specify year) \$92.00
900 \$92.00

ALLISON ELECTRONIC IGNITION
3-cyl. thru 900, in stock \$82.50

TECHNALON CAR COVERS
Protect your SAAB \$84.00

FREE CATALOG AVAILABLE

(404) 587-1356

VISA 8351 Roswell Rd, Suite 140
Atlanta, GA 30350



ROADSPORT

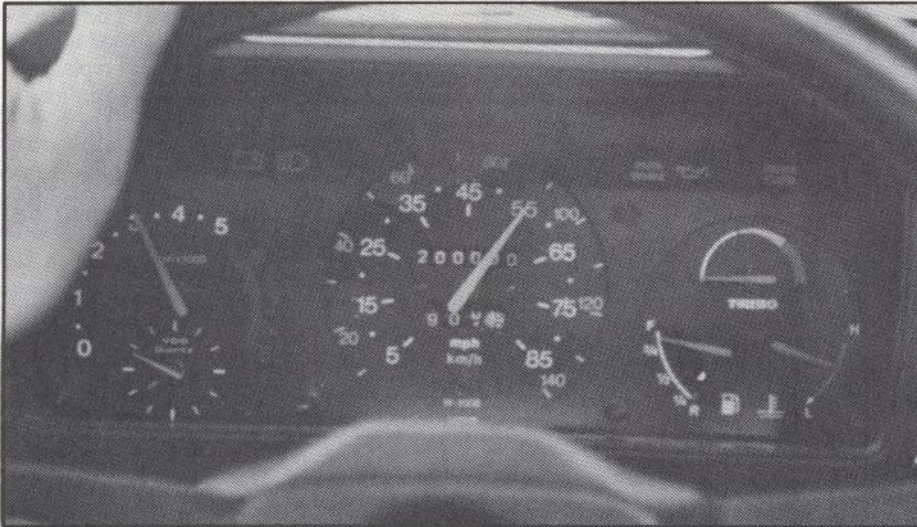

The (Real) Long Run

I've been enjoying my 1982 Turbo for eight years now. It's been a learning experience, not the greasy knuckle variety, but the kind that even suggests that you might do it again. Why? The car has been reliable. Not wildly expensive either, about eight cents a mile on the average. Last week the odometer rolled over 200,000 miles, so I feel not just compelled, but entitled to review some of the more obscure things I have learned:

Tires: P6's were the original equipment in 1982 and, excepting their poor performance in snow, I see nothing wrong with them. Somewhat novel is our use of 195/60VR15's at 30psi up front and 205/60VR15's at 32psi in the rear. The combination of slightly increased rear tire pressure and rear tire cross-section makes it difficult to unstick the rear tires, even at the limit. Sticky rubber on 16-inch wheels could make things even better; but despite the neat picture in the sales literature, even 1990 SPG's ride on 15-inch wheels from the factory.

Last fall, through *NINES*, I discovered the Nokia Hakkapeliitta NR09 tires for winter use. They are the finest winter tires I have driven on. I had been using Pirelli Winter 190's; but after one season on the Hakka's, there is no going back.

Suspension: I've had the IPD sway-bars on for the last 8 years. I had to weld reinforcing plates under the rear seat supports shortly after installation. This was required back in 1982 when there were no anti-roll bars fitted on even the turbos. Although I'm now on my third set of Koni shocks, the wear-softened original equipment springs have lowered the chassis rates considerably.

Engine: Not too much to say - it's a dream. I put in a quart of oil, or change the oil and filter, at alternating 2,500 mile intervals. The lower engine has never been touched. I developed a small crack in the head around 120K miles. This may have been due to my elevated boost operation. Shaved 25 mils off the new head, advanced

the cam timing, and it continues to enjoy its surge up the power curve.

Exhaust: Least reliable vehicle component. Seems to fail in one way or another every year or so.

Turbo / APC: Many readers wrote after my article on APC modifications back in the July 1984 issue. Since then, SAAB made the APC servo digital, designed a new 16-valve head, added an intercooler, and changed fuel injection strategies. These changes dwarf the power wins made back then by forcing up the boost ceiling. Nevertheless, after nearly 200,000 miles and 0.95 Bar boost pressure differentials, the original factory fitted turbo continues to spin.

Lighting: Good lighting is essential to safe nighttime motoring. At 150,000 miles I replaced both my European H4 main lenses and fog lamp lenses simply because they had been sandblasted by miles of road grit. Since I use 100 watt H4 and H3 lamps, I rewired and re-grounded each lamp with 12-gauge wire. Aiming of the sharp cutoff European lamps is also important. Here are two simple rules: Turn the outer adjustment clockwise to lower beam. Turn the inner adjustment clockwise to turn beam inward.

I would like to see *NINES* keep track of these long run vehicles. How many Saab's are on the road with 200K miles, 300K miles, or even half a million?

What allowed them to endure (or what did them in)? In the salt prone areas, I would guess that chassis erosion is the worst enemy over the years. I have a few small rust spots starting on the wheel wells, the roof gutter, and at the antenna fitting. I've been told there's not much to be done.

If *NINES* were to compile data on long run cars, the goal would be to try to provide some comparative numbers that readers could use to judge their vehicles against. Here is an idea of what I would find useful:

Year and Model:	82 923M
Miles Driven:	200,000
Miles per Year:	25,000
Average Service Interval:	4,033 mi.
Average Service Cost:	\$297.
Avg. Service Cost/Mile:	\$0.08

Maybe this article will open the floodgates of other long run owners and we can see Tim compile this in future issues!

Shep Siegel
Derry, NH

Exclusive

SAAB

Parts Center

The area's most extensive
inventory at
competitive discounts

(215) 886-8660

Free delivery locally
or Standard UPS

SAAB

VICTOR

Exclusively SAAB since 1958

1125-35 Easton Road • Abington, PA 19001
Facsimile (215) 572-5030



BAYSIDE

■ PORSCHE/SAAB/LOTUS



9000

	Reg. Price	SALE
Euro Headlite Kit	425.80	340.00
Engine Tuning Kit 86-89	312.00	250.00
Handling Package	946.50	756.00
Rear Decor Panel 9000T	236.00	198.00
Rear Decor Panel 9000CD	245.00	200.00
Hood Protection Strip	37.50	29.00
Chime Relay	52.10	41.00
Sunroof Wind Deflector	68.00	53.00
Cargo Mat 9000 4 dr. 89 —	96.60	75.00
Cargo Mat 9000 5 dr. 86 —	94.80	71.00

900

Euro Headlite Kit 87 —	430.10	345.00
Euro Headlite Kit — 86	477.60	380.00
Cargo Mat 3 dr. 81 —	69.20	54.00
900 CV Int. Cover 86 —	100.00	81.00
Hood Protection Strip	35.90	28.00
Air Springs 79 —	220.00	175.00
Spring Assisted Shocks 86 —	78.90	63.00
Leather Shift Knob	40.00	35.00
Air Outlet Covers 3 dr. 79 —	42.00	35.00
Whale Tail 900 3 dr.	556.00	500.00

99

	Reg. Price	SALE
Grille Assembly	94.50	75.00
Head Lamp Doors	34.70	27.00
Front Park Lens 71 - 76	37.50	29.00
Front Park Lens 77 - 80	44.30	35.00
Rear Taillight Lens 69 - 76	55.50	44.00
Rear Taillight Lens 77 - 80	71.70	57.00
Wagonback Tail Lens	71.70	57.00
Rear Side Lamp — 76	10.45	8.50
Rear Spoiler - Wraparound	240.00	160.00
Rear Spoiler — Straight	210.00	150.00

95-96-97

Front Park Lens 69 —	30.40	24.00
Rear Taillight Lens	38.00	26.00
5 Blade Fan	45.80	35.00
95-96 Windshield 68 —	151.50	120.00
95-96 Front Fender — 68	144.50	115.00
95-96 Front Fender 69 —	184.50	147.00
2 Stroke Front Muffler	63.00	50.00
Sonett III Front Header	57.40	46.00
Sonett III Rear Muffler	66.40	53.00
Rear Brake Shoes - Girling	29.95	22.00



VISA MC AMEX

(206) 328-2303

517 E. PIKE ST.
SEATTLE, WA 98122

1 800-537-9635 FAX (206) 322-4562



GOLDWING

USED SAAB PARTS WAREHOUSE

Nationwide Shipping UPS - COD

- Alternators
- Starters
- Axles
- Calipers
- Antennas
- Radios
- Wheels
- Tires
- Tail Lights
- Window Motors
- Rack-n-Pinions



- Transmissions
- Engines
- Radiators
- Grills
- Fenders
- Turbos
- Bumpers
- Air Compressors
- Cyl. Hds.
- Seats

Call 1-800-SAAB137 or (315) 676-3311
Rt. 11 Hastings, NY 13076

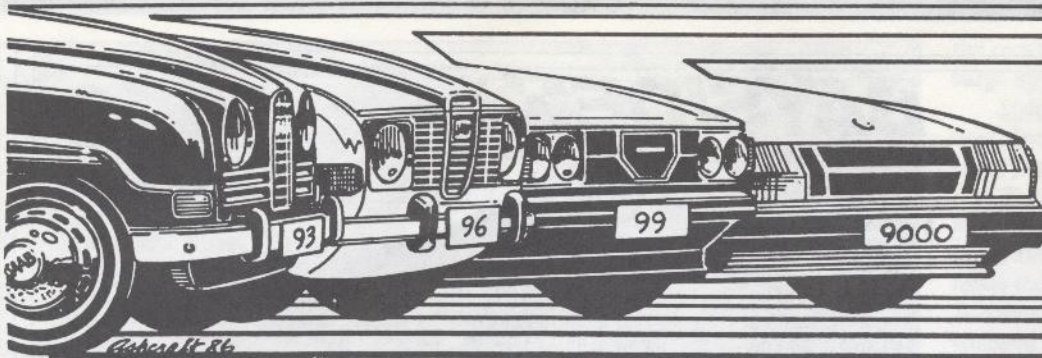

SAAB SWAP CLASSIFIED ADS

CLASSIFIED AD RATES

Ads offering parts or SAABs for sale or wanted are available to members and non-members. Ads are limited to 25 words, plus name address and phone number. Ad copy will be abbreviated and excess words deleted where possible. Enclose sufficient funds with your ad, we do not bill. No ads will be taken by phone. The Classified Ad rate is as follows:

	Members	Non-members
CARS FOR SALE	\$10.00	\$15.00
PARTS FOR SALE	\$5.00	\$7.50
WANTED ADS.	\$2.00	\$3.00
COMMERCIAL ADS (Parts & Services)	\$10.00	\$15.00

DEADLINE: The 15th of each month for the following month's issue, e.g. January 15th for the February issue. Newsletters are mailed the first week of the cover month.

COMMERCIAL DISPLAY ADS: Contact the editor for rates and info. Deadline, the 10th of each month for the following month's issue.

Sonetts For Sale

'74 Sonett III, Red, 125k mi, great condition, engine overhauled 5k ago, must see to appreciate. Asking \$5,000. Vikki Young, 5762 Longford Dr, Dublin, OH 43017. 614/464-5662 W, 614/792-8575 H.*

'74 Sonett III, beautiful fiberglass body recently painted Imron blue, mechanically pampered by Jack Ashcraft, new brakes, exhaust, shocks, rebuilt trans, freewheeling out. Photos available. \$3,900. Challie Evans, 11912 SE 175th #G301, Renton, WA 98058. 206/235-1091.*

'74 Sonett III, Blue, air, alloys, Swedish racing manifold, 32/36 DGEV Weber, freewheeling L.O., chassis strengthened, tinted glass, Hella lights, SAAB sunscreen, Maserati air horns, 3 cooling fans, Calif car, no rust. \$3,500. Terrence Waters, 33560 Mulholland Hwy, Malibu, CA 90265. 818/889-9390.

'74 Sonett III, 1990 NY state inspection sticker, runs & drives, easy restoration, 5 steel and alloy Saab wheels. \$1,500. John Runfola, 292 Temple St, Fredonia, NY 14063. 716/679-4981.*

'73 Sonett III, parts car. Steel timing gear, MSS manifold, carb, MSS exhaust, good tires, front end parts, 96 trans, plus spare trans. Best offer. Roger Libby, Atlanta, GA. 404/892-8102.

'73 Sonett #001573, Yellow, 29k mi, original and complete, air, 2 owner southern car, stored 10 years, never wrecked. Not running, not parting. Offers around \$2,750. John Ogilvy, 104 Whetstone Ct, Durham, NC 27703. 919/596-4077.

'73 Sonett III, body, paint, engine in good condition. Trans needs work. Extra used trans. Some rust in trunk. Owned for 12 years. \$1,400. Paul Natvig, 908 Marie Ave, Newberg, OR 97128. 503/538-7571.*

'71 Sonett III, soccer ball rims, runs good, needs slave cyl, under-carriage in excellent shape, body good, perfect for restoration. Asking \$850. Joe Kelly, Mineola, Long Island, NY. 516/747-2044.

93s, 95s & 96s For Sale

'73 96, Lemon Yellow, 170k mi, relatively clean, body fair, Weber carb, radials, good compression, stainless mufflers, recent work, extra parts car. Drive it home! \$499 \$300 obo. Peter Reimuller, PO Box 4, Point Arena, CA 95468. 707/882-2001.*

'68 95 2-stroke, interior, exterior & powertrain in good condition. Sound transportation. \$2,750. John Padley, 3155-A Gough St, San Francisco, CA 94123. 415/673-6611 eves.

'66 Monte Carlo 850, complete, interior/ exterior in good condition, stuck motor, new OS piston set & gasket set, many spares, will consider parting. \$750. John Ogilvy, 104 Whetstone Ct, Durham, NC 27703. 919/596-4077.

'66 96 2-cycle, 10k mi on rebuilt motor/trans. New interior, no rust, excellent condition. Sealed bids taken until Nov. 5. Rod Svee, 1004 Rangeview Dr, Hardin, MT 59034. 406/665-1230 after 6pm.*

'66 96 Stroker, Bob Werks porting, very clean stock Calif gem. Best Offer. Dick Landon, 219 Leonard St, Santa Cruz, CA 95060. 408/459-8010.

2-Stroke & V4 Parts

Fall Garage Cleaning! I have a few real gems & a whole lot of junk: 3-cyl triple carb block in unknown condition, radiator, heads, expansion chamber(s) 850 dash, much more... Everything 96, \$400; pick-it-over, \$500. Kelly Brandt, 9879 Bliss Rd, Lake Odessa, MI 48849. 616/374-7176.*

Reasonably priced new & used parts for your SAAB project: 95, 96, 97, 99 or 900. Send SASE with needs or call. John Ogilvy, 104 Whetstone Ct, Durham, NC 27703. 919/596-4077.

Sonett III parts: Good transaxle, \$150. Doors, \$30. Front or rear clip, \$350. Many more. James McBride, PO Box 17796, San Diego, CA 92117. 619/273-7042.

'71 & '72 Sonett owners manuals, \$20 ea (or trade for '74). Original white side stripe kit, \$50. Rear fiberglass, \$250. Doors, \$25 ea. New fuel sender unit, \$25. More. Ted Graef, 2195 Grant Rd, Quakertown, PA 18951. 215/538-7601.

99s & 900s For Sale

'82 900 Turbo 3dr, 5spd, Rose Quartz, AC, partially disassembled. \$1,600. Gordon Maney, RR 1 Box 59, Norway, IA 52318. 319/227-7846 late eves, wknds.

'82 900 Turbo body, eng/trans removed, 64k mi, Black/maroon interior, 3dr, 5spd, AC, SR, AM/FM stereo/tape deck, no rust. 165SR15 tires on steel rims, TRX alloy rims avail. \$3,700 obo. Dale Roble, Pittsville, WI. 715/387-1863 or 715/884-2786.

'80 900 Turbo, 70k mi, immaculate. New H2O inj, turbo, turbo oiler, trans, head, rack. VDO cluster, Momo steering wheel, P600 205/55 on Epsilon 2-pc 6" wheels, too many extras to list. \$7,000 obo. Gladwyn Lopez, 81 Hamilton Rd, Teaneck, NJ 201/838-1067.

'78 99 Turbo, Silver, 150+k mi, runs strong, good head, needs turbo work/tuneup. Recent radiator rehab, Dan Gurney mags, some body rust. \$1,000 obo. J. David Girard, Seattle, WA. 206/888-2821.

'76 99 EMS, '85 eng w/'84 5spd trans, AC, Ronal wheels, sway bars, new headliner, good transportation. \$2,000 obo. Rick Obert, 150 Cedarhurst Ln, Milford, CT 06460. 203/877-3327.

'76 99 Wagonback, Blue. \$1,000 or trade for 78-80 rebuilt 4spd transmission. Gene Keyser, PO Box 148, Armona, CA 93202. 209/582-0531.

'73 99 EMS, New dual 45DCO Webers w/MSS intake, alloys, good body, trans & engine. All my 99 parts included. \$600 obo. Will consider selling parts. Ted Graef, 2195 Grant Rd, Quakertown, PA 18951. 215/538-7601.

99, 900 & 9000 Parts & Accessories

900 Parts: 4 Shelby wheels w/caps, \$250; front sway bar, \$50; 81 exhaust manifold, \$75; 81 fuel distributor, \$40; 80 power steering pump, \$10; 81 fuel pump, \$40; more. Ted Graef, 2195 Grant Rd, Quakertown, PA 18951. 215/538-7601.

2 99 engines, 76-77, one used, one new, make offer; 2 EMS wheels, \$25 ea. Rick Obert, 150 Cedarhurst Ln, Milford, CT 06460. 203/877-3327.

2 99s: '74 Silver, Belgian, poor body, 4dr, 4spd, "was running until it quit". Early parts car, maroon, missing head. Both cars, \$200; one car, \$300. Kelly Brandt, 9879 Bliss Rd, Lake Odessa, MI 48849. 616/374-7176.*

900 parts: 4 EMS mags (79) w/lugs, as new, \$120; Aluminum rear louvers, \$100; driving lights w/brackets & switch 79-86 900, \$50; Personal leather steering whl, all 900s, \$100; 79-81 900 shop manuals, 2 binders, \$50; 81-87 900 shop manuals, 3 binders, \$90; 85-on 9000 shop manuals, 3 binders, \$110. Alan Bergman, West Des Moines, IA. 515/279-5150 after 6pm.

Complete Saab/Clarion sound system from '87 900T - radio, EQ, amp, cables, manual; perfect condition, \$495. Center consoles; 1 w/black carpet, 1 tan, \$75 ea. Saab/Clarion EQ from 85 900T, \$50. Bob Pierson, Freeland, MI. 517/695-5299 eves, 313/853-1917 days.

99, 900 OEM parts, wholesale prices to SAAB Club members. Aftermarket parts, engines, transmissions, large assortment of used parts. New cyl head, '81+. New style heater control valve. New style outer CV joint. Call for price. Trollhattan Motors Inc., 310 George Ave, Baltimore, MD 21221. 301/682-4688 or 1-800-32-TROLL. Evening & Saturday hours.

99, 900 headliner kit comes with glue, 3 1/2 yards of material and compete instructions, \$87.50. Other parts available. Trollhattan Motors Inc., 301/682-4688 or 1-800-32-TROLL. Evening and Saturday hours.

Your Saab manual transmissions rebuilt from \$795. Includes replacement of bearings and seals and set to factory specs. Why buy used and not be sure? Call for details, freight additional. Mastercard/Visa accepted. Trollhattan Motors Inc., 310 George Ave, Baltimore, MD 21221. 301/682-4688 or 1-800-32-TROLL.

Parting out ten 99s and sixteen 900s, 1973 thru 1986. New OE sunroof deflectors, 9000 only, \$40. Rod Beckner, 604 East First St, Albany, OR 97321. Tele/fax 503/928-6351.

900 parts - Best Prices. Engines, transmissions, body parts, etc. Free locating service. Gaylon-Walker Imports, 307 E. Lincolnway, Ames, IA 50010. 515/233-2201.

Parting out: '79 thru '86 900s. 8-valve, 16-valve, Turbos, SPGs. Drivetrains, interiors, body, suspension, wheels, rebuilt transmissions and more. Mike Caro, Wallingford, CT. 203/284-8989.

900 parts: Lambskin seat covers, set of 2, \$75 FOB. Set of front rotors & calipers, minimal use, \$200 FOB. Charles Hofman, Cherry Valley, CA. 714/845-5166 after 6pm.

86 900 4dr right rear side panel, p/n 9220906, \$200. S.S. wheel covers, \$40 ea. Harry Fleury, 16 Towers Rd, Essex Jct, VT 05452. 802/878-5423.

SAAB Club Special: CHIPS Detector programmable scanner, \$199. Scanner w/o alert circuit, \$139. Also radar detectors, CB's, & car audio at similar savings. Full manufacturer's warranty. Sunset Trader, 905 W Ream Av, Mt Shasta, CA 96067. 916/926-5473.

Rear decor panels, 9000, \$60. Ass't wheels, \$50-75. Ass't motors, switches, relays and more toys all going cheap. Lewis Eig, 914/352-6124.

Set of ADDCO anti-sway bars 900 (F&R), new, \$130 obo. Bernie Wassertzug, 11825 Enid Dr, Potomac, MD 20854. 301/299-8561.

Set of four '88 15-spoke wheels, great shape, will ship UPS, \$95 ea. 602/934-0893 lv msg.

Wanted, All Models

78-80 rebuilt 4-speed transmission. Have cores. Gene Keyser, PO Box 148, Armona, CA 93202. 209/582-0531.

Rebuilt V4 engine (1969-74) for placement in '69 96. Must be professionally rebuilt and in excellent condition. Would prefer a mild performance upgrade (street cam, lightened flywheel, etc.). Tom Mudd, 1001 Hoyt Ave, Saginaw, MI 48607. 517/754-3351.

2-cycle Monte Carlo pistons w/rings, oversize. Good new or used. Al Hauenstein, 547 Main St, Tell City, IN 47586. 812/547-4437.

Sonett III shifter assembly, the part inside the car. Also, top transmission lid for Sonett III and shift linkage assy that attaches to side of trans. Jack Ashcraft, 2201 Woodlawn Dr, Medford, OR 97504. 503/779-0731.

GT 850 engine wanted. Will pay well for reasonably fresh one. Rob Steinway, 540 Iris Av, Boulder, CO 80304. 303/442-4725.

BAD TURBO?
REPLACE IT WITH ONE
THAT WILL LAST

WATER COOLED
TURBO CONVERSIONS

FROM
\$499

We use the same Garrett Airesearch water cooled bearing housing that Saab uses on the new models and combine it with aircraft quality plumbing to offer you an elegant and highly functional replacement alternative to the outdated air cooled turbocharger.

SWEDEKIT®

SWEDISH REFINEMENTS, INC.
191 WESTON ROAD, BOX 622
LINCOLN, MA 01773
800-726-7740
Dealer inquiries welcomed



The FTC Motorsports 99 crosses the finish line at the Longest Day, 1990

SAAB's it in IT!

The Improved Touring (IT) Saab 99 of Jack Baxter continues to be competitive on road racing circuits in the Southeastern United States. Baxter reports the car has been pretty reliable and they've stayed in the points chase all year.

Their big race, as mentioned in previous issues of NINES, was the 24 Hours of Nelson Ledges in Ohio. The S & J Automotive/General Tire/Valvoline/Automotive Transformation SAAB 99EMS did not have a particularly good weekend. After motor-home problems, the car arrived too late to qualify and had to start dead last in the field of 48 cars. The team, whose drivers included Christine Shaw, Martin Holland, Tom Horan, and car owner Baxter, had the 99 up to 3rd place in class after two hours. Then third gear gave out on the transmission which necessitated a complete engine/gearbox swap including replacement of the starter solenoid. The crew, led by David Wolf, accomplished the job in just one hour and eighteen minutes!

That wasn't the end of problems as the 99 spent time in the pits for ignition trouble, a fuel pump repair, and replacement of the

lower left A-arm when the shock mount gave away. Still, the 99 ended up 6th in ITB out of nine cars, and 24th overall. And not a problem with the General XP-2000 tires (size 205/60-15 for those who must know).

Then there's the six-event Enduro Championship Racing series. The races are between one-and-a-half and three hours, with a 5 minute pit stop required. The 99's best finish this year was a first at Rockingham's one mile oval. A less exciting finish came at Moroso, where the throttle cam failed and dropped the Saab several places back, which cost valuable season points.

The EMS is currently 2nd in the ECR series trailing a 1972 Volvo 142E by just 4 points. A VW Golf (8-valve) is in third, a mere five points behind the 99. The final race of the ERC series will be Thanksgiving weekend at Sebring, Florida.

Baxter has also qualified for the South Atlantic Road Racing Championships (SARRC), to be run November 11 and 12 at Roebing Road in Savannah, Georgia.

He hopes to locate a limited-slip differential for the 99's 4-speed to get a bit more traction at the SARRC run-offs. If you can help, call Jack at 404/351-7222.

Sinclair drives Sonett II at vintage weekend

Saab's U.S. chairman and chief executive officer, Bob Sinclair, recently participated in the eighth annual Vintage Fall Festival at Lime Rock Park in Connecticut. Sinclair drove a 1967 Sonett II which is owned by Saab Cars USA, Inc.

The Sonett, number 197 of the 258 three-cylinder, two-stroke versions of the model, was recently restored at the Saab Car Museum in Trollhattan, Sweden.

The Fall Festival features vintage racing, a concours d'elegance car show, a swap meet featuring parts and automotive collectibles, and an auto art show.

'91 Barber Saab schedule

Skip Barber, who along with Bob Sinclair co-founded the Barber Saab Pro Series, has announced the 1991 series schedule. The IMSA- and FIA-sanctioned open-wheel, talent showcase series begins its sixth season in West Palm Beach on March 3, 1991. All listed dates are in conjunction with IMSA Camel GTP race weekends.

Barber also said that a 13th race may be added, perhaps an oval event, but noted that if an additional race couldn't be accommodated, one of the 12 races might be run with a CART Indy car race weekend.

1991 Barber Saab schedule (tentative)

March 3	West Palm Beach, FL (ESPN)
April 7	Miami, FL (ESPN)
April 28	Road Atlanta, GA (tba)
May 27	Lime Rock, CT (ESPN)
June 2	Mid-Ohio, OH (ESPN)
June 16	New Orleans, LA (ESPN)
June 30	Watkins Glen, NY (ESPN)
July 14	Sears Point, CA (tba)
July 28	Portland, OR (ESPN)
Aug. 18	Road America, WI (tba)
Sep. 29	Tampa, FL (ESPN)
Oct. 13	Del Mar, CA (ESPN)

AutoFile needs you

AutoWeek is looking for owner comments on the Saab 9000CD, either with the 2.3 liter non-turbo engine or the 2.0 turbo, for their AutoFile column. They will also take comments from owners of the 9000S with emphasis on the drivetrain.

AutoWeek requests that you have purchased the car new and have owned it for at least three months. They would like you to include your telephone number with your letter. Finally, please include your vehicle identification number (VIN), which is on your title and in the lower left front corner of the windshield.

In your letter, please tell what you paid for the car, when you

bought it and how many miles it has. They would also like to know your overall opinion of the car, specific likes or dislikes, how good - or bad - your dealer is, what you pay for insurance and what other cars you considered buying.

Send your responses to AutoFile, *Auto-Week*, 1400 Woodbridge, Detroit MI 48207. Or you may call Tim Dunne (313) 446-0343, Mark Vaughn (313) 446-1633 or Jim Sawyer (313) 446-0332. The deadline on the 9000 is December 10th; the results will be published before the end of 1990.

MEMBERSHIP/SUBSCRIPTION

(Use also for Change of Address)

NAME _____

ADDRESS _____

CITY/STATE/ZIP _____

HOME PHONE _____ WORK PHONE _____

SAABS CURRENTLY OWNED _____

(i.e. '84 900 S 4dr. automatic / '78 99 GLE 5dr. 4-spd / '72 Sonett III / '68 96-V4 Deluxe)

Annual Membership fees for the SAAB Club of North America/NINES are as follows:

First Year \$23.00
 Renewal \$20.00

Canadian add \$3.00U.S.

International add \$7.00U.S.

Please check appropriate box(es)

(Canadian and International -- Money order or check payable on a U.S. bank only. Cash OK.)

First year members receive two recent back issues of NINES and two SAAB Club stickers.

MAKE CHECKS PAYABLE TO "THE SAAB CLUB"

Address change only

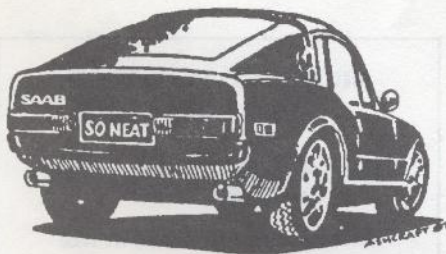

Rear View

Despite persistent rumors regarding a "Saab Calibra" to be sold in the U.S., it is unlikely that Saab will sell the car here. The Calibra was designed by Opel for the European market, not America. It would take considerable redesign to meet U.S. safety and emission standards. That could take several years, say 1993 or '94. By then Saab should have its replacement for the 900 in the showrooms.

Several other manufacturers can be expected to have a sporty-looking coupe on the market in the next few years. Already we have the Ford Probe, the Geo Storm, the Dodge Stealth, and even the Hyundai Scoupe. It probably will not be such a lucrative market to enter by the time it would take to re-engineer the Calibra.

Working on a Saab version of the Calibra would also take engineers away from the current projects - the new 900, a higher market Saab due about 1995, and the replacement for the current 9000.

Decision makers at Saab Cars USA who have driven the Calibra have not been impressed with the handling. It is, after all, just a nicer shape on an Opel Vectra chassis. They feel it would be too much of a compromise, and, as the ad slogan goes, "We don't make compromises..."

I picked up a real gem at a used book sale -- Ken W. Purdy's *Wonderful World of the Automobile*, copyright 1960. The book covers great cars, racing drivers and auto industry giants.

Several chapters cover the aspect of automotive safety, and suggest that manufacturers should include padding on the dashboard, safety belts, a collapsible steering column, and other safety items as standard equipment. Much of Purdy's verbiage is aimed toward the use of seat belts to save lives in an accident; more specifically, lap belts, since that was really all that was available in 1960.

One drawback of lap belts, according to Purdy: "They do not... prevent 'jack-knifing,' the deadly whipping forward of the upper part of the body on the hinge of the hips. For this only a shoulder harness will do. Shoulder-harness belts are available as standard equipment only in the Swedish SAAB."

Purdy also singled out SAAB for its use of pictorial symbols on the dash controls for ease of identification, comparing them to those found in aircraft.

You're familiar with Snigglets? Try this one: autobonding (*aw' toh' bond ing*) v. While on the road, the compulsion to wave at the person next to you because they're driving the exact same model car.

What do you call flashing your headlights at other Saabs?

The sacrifices I make... I have just returned from my first press junket, sponsored, of course, by Saab Cars USA, Inc. Writers from several car magazines were invited to attend the Paris Auto Show, then were given two days on the German autobahns at the wheel of the new 2.3 liter 9000 Turbo (dodging recently liberated

Trabants and Wartburgs).

Having spent some unrestrained time behind the 2.3 turbo engine on the German freeway (the speedometer read 238 km/h - 148 mph - at one point), I can attest to the remarkable power of this four-cylinder mill. Dr. G. M. Metz's evaluation on page 16 pretty much sums up my feeling on the car.

I also had a chance to visit with some of Saab's movers and shakers including Bob Sinclair, Steve Rossi, David Herman, Bjorn Envall and Per Gillbrand.

That explains the lateness of this issue. (I had considered combining October and November in an attempt to get back on schedule.) More details of the trip in the next NINES.

Car and Driver magazine is said to have run a 0-60 time of 6.4 seconds in the new 9000 Turbo 2.3. How does that compare? According to *CD*'s "Road Test Digest", faster than a Ford Taurus SHO, Infiniti Q45, or Lexus LS400; just a tick slower than the Eagle Talon AWD and Mercedes Benz 500SL (both 6.3 sec.), and Ford Mustang LX 5.0, Toyota Supra Turbo, and Ferrari Mondial t Cabriolet (all 6.2 sec.).

That would make the new 9000 Turbo the quickest front-wheel drive car available in the U.S.

Due to weak auto sales in three of Saab's biggest markets -- Britain, Scandinavia, and the United States -- David Herman, president of Saab Automobile AB, has revised his outlook. Shortly after being named to head the Saab/GM joint venture, Herman said he thought Saab could show a profit sometime in 1991 (March issue, pg. 8). Now, due to slow sales and poor currency exchange rates, Herman says, "I don't know if it will come true."

Tim Winker, Editor

