



NINES

THE SAAB CLUB NEWSLETTER

\$1.50
Aug/Sept
1987
no. 162

9000 "PASSES" NHTSA CRASH

The latest National Highway Traffic Safety Administration crash test results bear out what Saab-Scania has said all along: The Saab 9000 is a safe and well constructed car. NHTSA's crash test figures are actually better than those based on Saab-Scania's own tests, published in the July issue of NINES.

As part of its New Car Assessment Program, NHTSA crashes new cars into a fixed barrier at 35 miles per hour, 5 mph faster than the speed prescribed for compliance with federal motor vehicle safety standards. The experimental program is designed to demonstrate relative crash protection provided to front seat occupants wearing safety belts.

The NHTSA says in its release: "It is also important to emphasize that in the government's crash test program only one vehicle of any given make or model is crashed in a specific test. Research has shown that subsequent crash test results for any vehicle could vary due to slight differences in the way

CRASH TEST

Cont. on page 17

SAAB EXPANSION PLANS SINK

A ship carrying machinery to the Saab factory in Trollhattan sank off the coast of Yemen in early July, taking Saab's plan to increase automotive production with it.

According to an article in the July 20th issue of Automotive News, the vessel, Conti Belgica, was en route from Hitachi in Japan to Sweden when it ran into a hurricane and went down two hours later. The crew was rescued.

The ship was carrying three main presses that Saab intended to use to increase production by 30,000 units per year. The new machinery was to be installed in Saab's Trollhattan plant after the August vacation.

Saab had recently been reducing the volume of parts from outside suppliers in anticipation of the new equipment from Japan. Saab is now asking for resumption of those deliveries.

Representatives of Hitachi have discussed replacements with Saab, but it is unlikely they will be able to provide new machines for about a year.



Old meets New at the Tulsa convention. Chris Adams' 1956 Saab 93 and one of the Long Run 9000 Turbos at the Concours.

ONE DOWN, ONE TO GO

The national convention for 1987 is past, while the Saab Jubilee in Sweden is rapidly approaching. The National Saab Owners Convention in Tulsa, Oklahoma, saw about 200 Saab fans from around the United States and even a few from Canada. Though the number of participants was down from previous years, the enthusiasm was definitely up.

The Friday night Get Acquainted party featured Saab video tapes, "How I Did It" slide shows by members, and a personal appearance by one of the three 9000 Turbos used in the Long Run. A 900 Turbo Convertible was also on display.

Saturday morning was reserved for Tech Sessions (given by tech people from Saab's Central Region), the Swap Meet, and the Concours. A good selection of 2-Strokes, V-4s, Sonetts, 99s, 900s, and 9000s were prettied up and put on display in front of the Children's Medical Center near the host Hilton Inn. The People's Choice Award went to the oldest car at the convention, a 1956 93 being restored by Chris Adams of Meyer Garage in Iowa.

There were two ralliees to give your Saab a workout; a "Gumball Rallye", TSD style through river country south of Tulsa, and a "See Tulsa" gimmick rallye which went

TULSA CONVENTION

Cont. on page 17

JUBILEE SCHEDULE FINALISED

The Swedish Saab Register and Saab-Scania have announced the schedules for the International Saab Clubs Meet in conjunction with Saab's 50th Anniversary celebration. The Saab Jubilee will be held the weekend of August 29-30.

The Saturday events are being organized by Svenska Saab Registret and will take place at the factory footballground in Trollhattan starting at 12:00 noon. Activities on the schedule include an "Autojumble in miniature", team games between international clubs, and a Concours de elegance for Saab Sonetts and two-stroke cars. The club shops will also be open, and it is recommended to bring T-shirts and club decals for trading.

Sunday's action is at the Saab factory in Trollhattan, which will be open all day with ongoing production of Saab cars. A Saab Clubs' Centre will act as a meeting point for club members, with Registration from 8am to 12noon, and

SAAB JUBILEE

Cont. on page 17

* **NEW TELEPHONE NUMBER** *
* The Saab Club/NINES has a new*
phone number effective immediately
It is (218) 724-1336. The mailing
*address has not changed. *

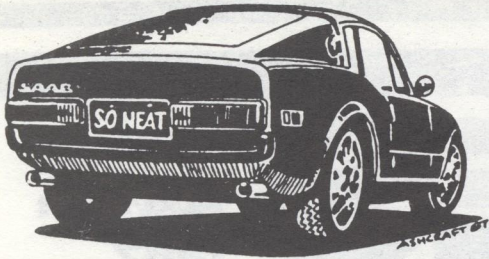

FROM THE BACKSIDE

I must be doing something right. Anyone who offered a comment at the recent national convention in Tulsa said, "You're doing a great job with the newsletter, Tim." Quite a bit of the mail has similar notes. The number of newsletters sent out each month is growing, too, partly due to ads in the major car magazines, partly because the percentage of renewals has increased. 3400 newsletters were mailed in July, plus another hundred or so late renewals. We are now averaging about 100 New subscribers each month, but still lose about 30-40 who don't renew because they've sold their Saab or have lost interest.

It's been a busy month for me. I bought a house, which gives me larger office space (and a double garage, of course). That means a new telephone number (see front page). Though my residence has changed, the mailing address remains the same. The secret is out, the London Road address is a mail drop, Unit 900 measures 4" wide by 5" high by 16" deep. It is very convenient as they will hold mail if I'm out of town, and they have a copy machine and shipping facilities. It also allows for a more permanent address, a very important consideration since I still get mail every week addressed to Oneida Street, and I know Dick Grossman still gets inquiries occasionally, though he hasn't been editor since 1980.

Then there was the Tulsa convention, which was great fun for me. It's always nice to meet people who share your interests, and to re-establish old friendships. It's unfortunate that the turnout was lower than in past years, but that could be for many reasons, not the least of which is the location. Tulsa is not close to any major center of Saab ownership, though it did give those in the midwest a chance to participate. Tulsa is also hot and humid in July, so I'm sure there were plenty of folks who don't have the luxury of auto air conditioning who decided to forgo a

long highway trip. Too bad, you missed a good time.

Saab-Scania was very much in evidence again, providing door prizes, displaying the Long Run 9000, and bringing Erik Carlsson as a banquet speaker. Thanks to Bob Sinclair and Len Lonnegren and the others at Saab-Scania of America for their continued support of our activities.

I'd also like to thank Dave Parps, who I met several years ago at a PRO Rally in California. He is a now a "Service Advisor" for Steven Motors in Grafton, Wisconsin, and president of the Milwaukee Saab Club. Dave drove, I navigated in the "Gumball Rallye". I think we placed third. We blew the big trap of the rallye, missed a sign and got one big score.

One of the very productive meetings at the Tulsa convention had to do with a "National Saab Club" structure. The Saab Club is set up as a proprietorship for ease of bookkeeping. But the Saab Club is more than a video club or a health club whose sole purpose is to make money, it is a trust, a service and commitment to Saab owners. (Yes, I make my living publishing NINES, and I work full time on it. Based on the comments mentioned above, the effort must show.)

Representatives of many regional Saab Clubs and other interested parties got together to try to form a true national organization. The suggestion is to have an advisory board, possibly made up of representatives from the regional clubs plus some at-large reps, who will address the problems of liability insurance for the regional clubs, to select a site for the National Convention each year, and to ensure the continued existence of the newsletter should a catastrophe befall the editor. If you would like to offer input toward a national Saab Club, send your suggestions to:

Margrit Adler
1507 University Ave.
Champaign, IL 61821

The suggestions will be evaluated at an organizational meeting, tentatively scheduled for this January. Dave Parps of the Milwaukee Saab Club offered to host the meeting. Andy Federowski, by virtue of his work done toward a national Saab Club, is the acting chairman. It is hoped that the organization will be in place by next summer's convention in Wilmington so the first official annual meeting can be held there.

NATIONAL DRIVERS ASSOCIATION?

The Citizen's Coalition for Rational Traffic Laws (CCRTL) is considering a name change, something better descriptive of the group's membership. All of the possibilities

center around "Drivers" or "Motorists". The group will continue to lobby for reason in traffic laws.

Their most recent campaign is for Lane Discipline. It will emphasize the value of courtesy (too late in Southern California?), and the promotion of a universal passing signal and request for slower vehicles to yield to the right. To quote the latest CCRTL Newsletter:

"From this day forward the signal for passing on a divided highway shall be the flashing of the left directional light. Vehicles in the left lane shall yield to the right lane when approached from the rear by a vehicle with the left directional on."

"SLOW TRAFFIC KEEP RIGHT, PLEASE" bumper stickers are available from CCRTL. A \$2 set consists of one conventional sticker for the rear bumper and one reverse print sticker for the front (so it can be read in the rear view mirror). They are free with a \$20 membership. Write:

CCRTL
6678 Pertzborn Road
Dane, WI 53529

Next month, the report on the Saab Jubilee.

Tim Winker

REGIONAL CLUB NEWS

CENTRAL PENNSYLVANIA SAAB CLUB is planning a joint party with the Twin Tier Saab Club of New York, on Sept 27th, at Tim Brown's cabin in Eagle's Mere. For more info, call Tim at (717) 627-3805. Meetings on the 1st Tuesday of the month at Bube's Brewery, Mt. Joy, PA. For more info contact Paul Bolesta (717) 292-5496.

MILWAUKEE SAAB CLUB has several events scheduled for August:
22nd - Autocross at Blackhawk Farms
23rd - Annual Picnic at Col Heg Park
30th - Barber/Saab Pro Series race at Road America in Elkhart Lake.
Dave Parps, 5103 Lincoln Creek Dr., Milwaukee, WI 53218. (414) 461-4818.

NEW ENGLAND SONETT CLUB -- P.O. Box 4362, Manchester, NH 03108. Next meeting scheduled for Sept 19th or 26th. Plans are to meet at Sports Car Service in Wilmington, DE.

TIDEWATER SAAB CLUB (Norfolk, VA area) meets the 4th Tuesday of each month at 7pm at Lester Motors Saab in Norfolk. Alan Bellinoff, (804) 340-7097.

WESTERN PENNSYLVANIA SAAB CLUB -- Picnic scheduled in October. Contact Andy Bittenbinder, (412) 364-4780.

Saab Club of North America

Editor & Publisher: Tim Winker, 2416 London Rd., Unit 900, Duluth, MN 55812

(218) 724-1336, 9 a.m. - 8 p.m., except Sunday

ASK BOB

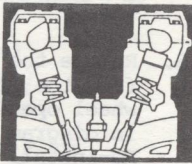

"ASK BOB" is a regular feature of NINES. Submit your questions with as complete information on the problem as possible, also giving the year and model of SAAB. Problems that are of general interest will be answered here. Questions regarding High-Performance tuning and modification will not be considered for publication in this column.

Neither Bob, NINES, nor the Saab Club will be responsible for repairs undertaken as a result of information in this column. For a proper diagnosis, it is recommended that you have your car serviced by an authorized Saab dealer.

And now the flak starts. Letters telling me I raped their letter, letters disagreeing with my answers, requests for more and private replies. Well, fellers, if it makes you feel better, shoot away. However, I will say again that it is difficult to answer some of these letters. Some are as short as three or four sentences., so I have to try, number one, to figure out the problem, and number two, to give the most probable answer. Of course I can't hit the exact answer every time, but I try.

One specific comment, I caught hell about "Saab not recommending synthetic oil". I still say that. If you can see a recommendation in them saying go ahead and use it, but change it the same as regular oil, then you've interpreted it differently than I do.

As far as shortening letters, occasionally there is one that is quite long, and often contains a lot of guff about SAAB and the local SAAB dealer. I don't feel we need that kind of stuff in a technical column.

And now to put on my flak vest.

*** **

My '79 99 heats up in stop and go traffic. I've replaced the thermostat and thermo fan switch, but the problem continues. It gets nearly to RED before the fan kicks in.

T.W., MN

A lower temperature thermostat will not fix it. Remember, the thermostat is there only to give a quick warm up. If the fan won't keep it cool, I'd urge you to have the radiator "rodded". That is a crossflow radiator with the inlet and outlet on the top. After 8 years a lot of sediment will have plugged several tubes on the bottom, essentially giving you a smaller radiator.

The mileage counters on my '79 900 only record mileage about 1% of the time. Can I repair without removing the unit? Can I remove the fuel accumulator on the side of the gas tank without any adverse conditions? And how can I remove a gearbox plug when the square insert is rounded out?

T.P., CA

Some speedo trouble was caused by the auxiliary cable that goes to the mileage counter. remove the speaker grille and try disconnecting it (remember, it is a violation of Federal law to disable it

permanently), but I feel after all this time that the problem has been there too long for any quick fix.

If you remove the fuel accumulator, it will take a long time to start the car cold, as the accumulator holds pressure to the injectors so that you can immediately start spraying gas on cranking. It would be almost impossible to start hot.

On the plug -- try a 3/8" breaker bar with a jack under it to hold heavy upward pressure. I've taken some out by hitting the edge with a cold chisel and hammer, but I've heard of broken transmission cases from this method. If you want to change the oil, buy a suction gun and suck it out through the filler hole. A little "no-sieze" compound on the threads of these plugs helps in later removal. Remember, tighten, but don't play Charles Atlas. And never use an air gun on these (though your friendly service place might).

I just had the clutch fixed on my '72 Sonett and when I shift and release the pedal, it surges VERY harshly. My mechanic says "that's how it is", but it never did it before. Will this action affect my transmission?

D.S., CA

What was the "fix"? Assuming a complete clutch job, something was done wrong. No grease on the pilot shaft splines, a blob of grease on the clutch lining (which sometimes makes it slip, sometimes makes it grab), a bent clutch plate -- but in no way is it normal. I'd say try a different mechanic, even though it will cost you money. In my opinion, a V4 transmission is too expensive to take any chances. I wouldn't want to "harshly" mine.

I have an '84 Turbo with 64k miles that has been well maintained. How will I know if the turbo is going bad?

N.K., MI

Clouds of blue smoke out the back. I've changed 'em at 60k, I've seen good ones at 100k, but remember, a turbo is a consumable item. Follow the instructions in your Owners Manual re starting up and stopping, change the oil as requested, and prime the turbo by several short crankings (high voltage disconnected and grounded) before starting after you change the oil. Incidentally, I don't believe the 10-minute oil change shops do this.

The electric antenna on my '85 SPG won't go up every time. It may go up after some driving. But it always retracts 100%. Can I fix?

A.S., PA

An occasional wiping with a rag or paper towel and some WD-40 or similar will help the mast slide up and down nicely. However, does your motor "time out" before the antenna gets all the way up? SAAB has used a couple of different suppliers, but basically they all work on a timing relay. I don't believe there are parts available, a new antenna is my recommendation. There are cheaper ones available, but I haven't had much success with them.

BOB

CORRECTION: A typing error changed the meaning of Richard Johnson's letter in the July issue. The first line should read: "I've used nothing BUT AMS/OIL in my cars..."

TW

Send your questions to:

ASK BOB
c/o NINES
2416 London Road, Unit 900
Duluth, MN 55812-2221

BOB YATES IMPORT CAR SPECIALISTS

- * Genuine SAAB factory parts
- * Club discount
- * Knowledgeable, fast and friendly service
- * NOW AVAILABLE!! - Direct shipment from SAAB to you. Ask for details.

CALL:

215-752-3000

Rt. 1 & I-95
Langhorne, PA 19047

SERVICE SUBJECTS

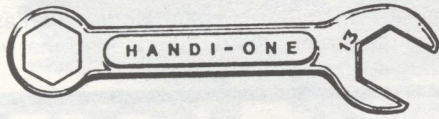

FROM SAAB

A/C HOSE CLAMP TO PREVENT EVAPORATOR CRACKING

Application: 900 models with "H" engine, M81-
S.I. 06/87-970, A-8/p.104

When replacing an AC evaporator due to cracking, always install the new AC Hose Clamp P/N 94-81-961 in place of the original clamps. The new clamp reduces the level of engine vibration that can be transmitted to the evaporator. Certain models (those equipped with the Seiko-Seiki compressor) also require the addition of a wire guard beneath the clamp to protect against wire chafing.

Hose Wire Guard* 94-81-961
75-35-487
*Seiko-Seiki compressor only

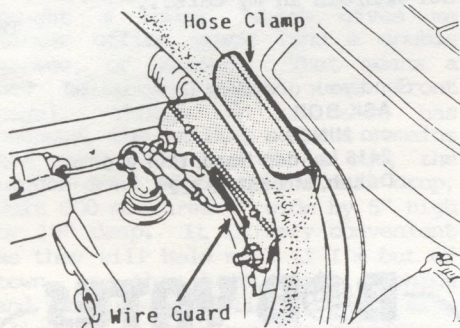

Before replacing an evaporator that is suspected of being cracked, always check the integrity of the expansion valve (copper tube evaporator only). Replacement of an expansion valve is simpler and more economical than replacing the entire evaporator.

From the following VIN Serial Nos., the new clamp was also introduced into new car production:

H2013351-
H3013076-
H7018819-

CORRECTING GLOVEBOX DOOR ALIGNMENT

Application: M86 & early M87 9000s
S.I. 06/87-972, B-8/P.19

A service kit is now available to allow adjustment of the glovebox door on M86 and early M87 9000 models. This adjustable glovebox door was also introduced from VIN Serial No. H1022780.

Glovebox Service Kit 96-98-309

A copy of this 9-page Service Information is available from the Saab Club for \$2.00

INSTALLING REAR MUD FLAPS

Application: 900 models 1979-86
900 models 1987-

S.I. 06/87-973, A-9/P.70

Instructions (M79-86),

Kit 78-74-340

Kit contents:

- A. 1 Left Rear Mud Flap
- B. 1 Right Rear Mud Flap
- C. 10 Phillips Head Screws
- D. 2 Fixing Plates
- E. 2 Backing Plates

Fixing Plate

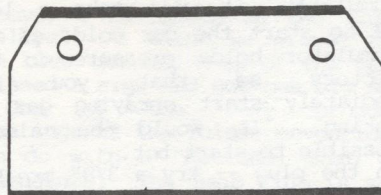

Backing Plate

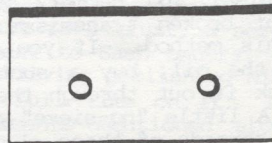

Tools required:

- A. 3/16" Drill
- B. #2 Phillips Screw Driver
- C. Cutting Pliers
- D. Undercoating Spray

1. Support car on a lift or jack stands & remove both rear wheels.
2. Drill out the five (5) rivets in each of the rear wheel openings with a 3/16" bit.

5 Rivets



R/R Wheel Opening

Wheel Opening Molding

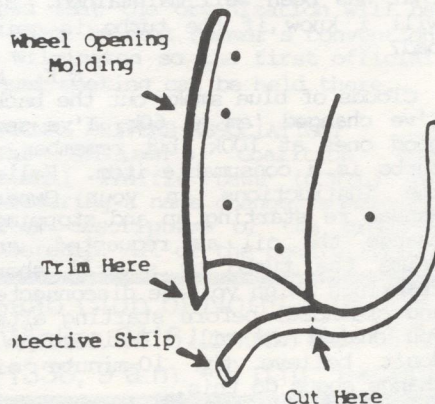

3. Remove the protective strips from the lower rear edge of the wheel openings and trim as shown in diagram (where applicable). Re-install inner part of protective strips.

NOTE: The area exposed by removal of protective strip should be sprayed with undercoating (both sides).

4. It may be necessary to trim the lower rear end of the wheel opening molding so that it does not extend past the end of the wheel opening.
5. Locate backing plate over the inner screw hole with the thick edge facing the outer edge of the wheel opening. Install mud flap with the three (3) lower screws.

NOTE: Put the screw through the upper hole in each backing plate. Plate is mounted behind mud flap.

Locate Backing Plate Here

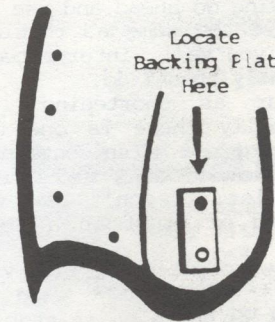

6. Install fixing plate with the two (2) upper screws. Plate should be positioned to hold mud flap against wheel opening molding.
7. Undercoat the heads of mounting screws.
8. Reinstall wheels.

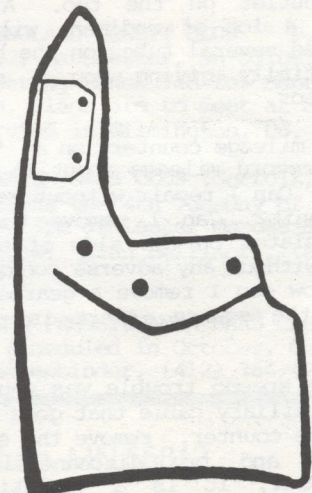

SERVICE SUBJECTS continued

Instructions (M87-on)
Kit 69-39-383 (4-door)
Kit 69-39-375 (3 door)
Kit contents:

- A. 1 Left Rear Mud Flap
- B. 1 Right Rear Mud Flap
- C. 6 Phillips Screws 6.3 x 16mm
- D. 4 Phillips Screws 6.3 x 13mm
- E. 4 Inserts
- F. 2 Pieces Protective Strip
- G. 2 Fixing Plates
- H. 2 Backing Plates
- I. 2 Screws 4.8x19mm (w/washers)

NOTE: 4 screws #8 x 1/2" are needed for installation and are not supplied in earlier kits.

Tools Required

- A. 1/16" and 3/16" Drill Bits
- B. T-10 and T-25 Torx Drivers
- C. #2 Phillips Head Screw Driver
- D. 8mm & 10mm Socket or wrenches
- E. Spray Undercoating
- F. Small Round File

1. Support car on a lift or jack stands and remove both rear wheels.
2. Remove the end pieces from the rear of both wheel housings (4 screws each).
3. Using a 3/16" drill bit, drill out the two (2) rivets in each of the rear wheel housings.

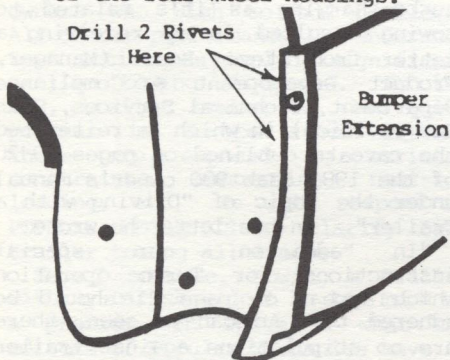

L/R Wheel Opening

4. Install the protective strips on the inner edge of each rear wheel housing (the protective strips are standard equipment on most models).
5. Remove the small screws (T-10 torx head) securing the top

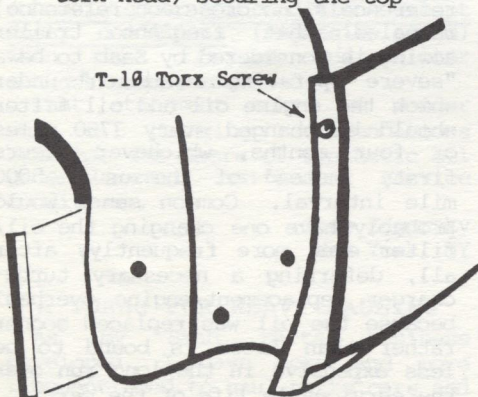

protective Strip

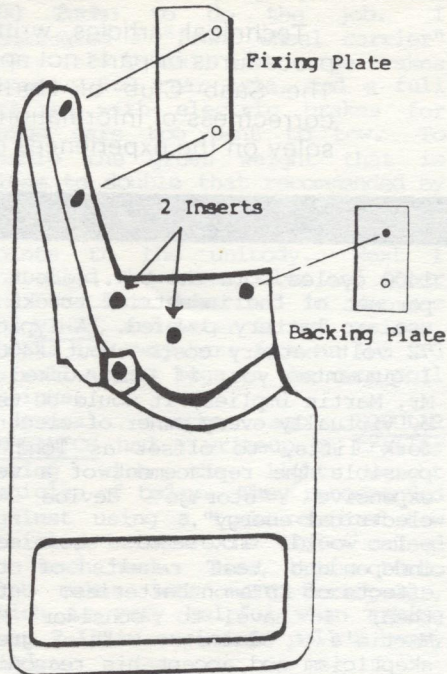

6. Press 2 of the inserts into each of the mud flaps as shown in the figure.
7. Mount the mud flaps using the holes with the inserts and two (2) 6.3 x 16mm screws.
8. Locate the backing plates over the mud flaps as shown and mount them with two (2) 6.3 x 16mm screws.
9. Install the fixing plates at the top edge of the mud flaps using four (4) 6.3 x 13mm screws. It may be necessary to adjust the position of the bumper extensions to achieve a good fit with the mud flap.
10. Install the 4.8 x 19mm screws through the mud flaps into the lower inner corners of the bumper extensions. Align mud

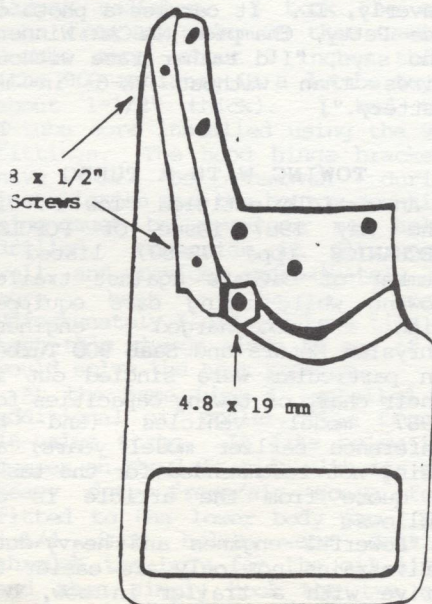

flaps and bumper extensions before securing the screws. In extreme cases of fitting difficulty it may be necessary to enlarge or elongate the holes in the mud flaps to achieve a good fit with the bumper extension.

11. Drill a 1/16" hole through the mud flaps and bumper extensions near the top. Install a #8 x 1/2" screw through each of the mud flaps and bumper extensions into the inner part of the wheel arch moldings. (These screws replace the small T-10 torx screws which were removed.)
12. Drill a 1/16" hole through the mud flaps and bumper extension, near the bottom of the bumper extensions, and install a #8 x 1/2" screw into each hole.
13. Reinstall the wheels.
Wheel Lug Torque 65-80 ft. lbs.

Saab Service Information Updates are provided to NINES as a courtesy to Saab owners by Daniel L. David Manager of Technical Services, and Robert J. Sinclair, President of Saab-Scania of America, Inc.

IMPORT MOTOR PARTS WAREHOUSE DISTRIBUTOR

110 West Twelfth Street / Pueblo, Colorado 81003
TOLL FREE 1-800-999-1920 ASK FOR SCOTT

BOSCH

Original Bosch Fuel Injection Parts			
69-74 99E, 99EMS All	Fuel Pump GFP270	#109.63ea	
75-81 99 & 900 All	Fuel Pump GFP213	#105.75ea	
82-86 900, Turbo to 84	Fuel Pump GFP202	#166.47ea	
75-77 99	Fuel Diat FD10X	#153.00ea	
78-81 99, 900 Turbo	Fuel Diat FD23X	#175.00ea	
78-81 99, 900 Non Turbo	Fuel Diat FD18X	#158.00ea	
82-86 900 Turbo to 84	Fuel Diat FD30X	#190.00ea	
78-80 All Turbos	Warpup Reg 0438140051	#89.92ea	
76-80 All NonTurbo	Warpup Reg 0438140020	#68.62ea	
81-83 All	Warpup Reg 0438140084	#123.92ea	
75-80 All	Injectors 0437502004	#16.88ea	
81-86 All	Injectors 0437502012	#17.63ea	
80-4/85 All	Fuel Filter 0450905401	#11.97ea	
77-86 All	Lambda Sensor 0238001026	#41.60ea	
75-80 All	Cold Start Valve 0280170401	#30.12ea	
69-74 All	Trigger Contacts 1230090005	#30.16ea	
79-80 All	Fuel Accumulator 0438170010	#58.75ea	
67-74 Various	Alternator AL95X	#59.95ea	
74-4/78 NonTurbo	Alternator AL96X	#87.00ea	
3/78-80 99 Turbo	Alternator AL36X	#123.95ea	
79-80 900 NonTurbo	Alternator AL112X	#84.95ea	
70-74 99 All	Starter SR77X	#72.95ea	
75-84 99, 900 All	Starter SR78X	#80.00ea	

SACHS

Original Clutches (All new parts!!!)			
69eaon 99&900 NonTurbo	Plata 3082 100 041	#41.06ea	
77- 99&900 Turbo	Plata 1850 480 043	#73.15ea	
69eaon 99&900 NonTurbo	Disc 1861 688 042	#43.13ea	
77- 99&900 Turbo	Disc 1861 717 003	#39.18ea	
69-75 99	Brg. 1850 282 622	#29.12ea	
76eaon 99&900 All	Brg. 1850 282 744	#10.99ea	

BILSTEIN.

Shocks And Struts			
67-84 96,97,99 All	Front Shock B46-0385	#66.02ea	
67-74 96,97	Rear Shock B46-0393	#59.36ea	
68-7/78 99 All	Rear Shock B46-0395	#66.02ea	
8/78-85 99, 900 All	Rear Shock B46-0397	#66.02ea	
7/78-85 900 All	Front Shock B46-0387	#66.02ea	

MONTHLY SPECIALS

Miscellaneous Saab Parts			
69-74 96V4 & 99	Heater Cyl 25-09107	#65.38ea	
75-84 99 & 900 All	Heater Cyl 25-09108	#103.25ea	
69-76 99(8 cog gear)	Water Pump 28-09103	#69.13ea	
77-80 99 & 900 All	Water Pump 28-09105	#56.34ea	
79-84 900 & Turbo	Wolf Brs BT702	#77.50ea	

AND MUCH MUCH MORE

Note: We carry complete lines of Bosch, Bilstein, Sachs, and other parts for imported cars including Saabs. If you don't see what you need, give us a call, and we will help you get hard to find parts with easy to swallow prices.

TECHNICAL TALK

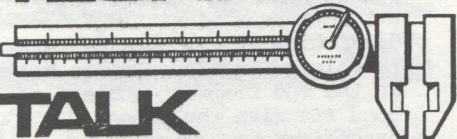

Technical articles written by subscribers may recommend procedures or parts not approved by Saab-Scania of America, Inc. The Saab Club of North America cannot stand behind the correctness of information in these articles, but offers them based solely on the experiences of the writers.

POSSIBLE 900 FIRE HAZARD

I would like to warn other Saab owners of a problem on 900s that could cause an electrical fire and burn up the rear wiring harness. I was adjusting the mixture and timing on my '81 900 Turbo, then performing short test runs up the road to verify the results. After about 30 minutes, the car refused to start. There was no voltage to the fuel pump due to a blown fuse. The fuse blew because the catalytic converter had overheated and melted the wiring harness, which is located above the converter inside the car. Also the handbrake cables were damaged by the heat. The plastic housing melted into the cables and locked the handbrakes the first time they were applied.

After asking around, I discovered at least one other fire of this nature in Austin. The circumstances were similar. The owner took the car in for detailing. When the engine was cleaned, it developed a "miss". The car was left running for 20 minutes to dry out the engine. The converter overheated and caused over \$4000 damage.

This problem can be prevented by removing the carpet over the tunnel and rerouting the harness above the floor vents. It is not necessary to disconnect any wiring. This separates the wires from contact with the floor and prevents them from getting hot enough to melt, even if the converter gets overheated.

A. J. Seippel
Austin, TX

[I received a phone call about a similar occurrence from Don Shobrys of Houston, TX, the day before this letter arrived. Has anyone else had this problem?]

TW

BATTERY LIFE & EDTA

I have worked with lead-acid storage batteries for about 20 years; 6-8 and 12 volt automotive and 24, 36, 48, 72, and 80 volt "traction" batteries. The lead-acid battery has a finite life, based primarily upon the number of charge-discharge cycles it endures. A typical lead-acid traction battery (as used in electric lift trucks) will undergo about 1200 charge-discharge cycles before it needs replacement. No chemical will restore the battery after it has undergone its useful life of 1200 to

1400 cycles. In the U.K., about 80 percent of the industrial trucks in use are battery powered. A typical 72 volt battery costs about \$4000. I guarantee you, if EDTA worked as Mr. Martin implies, it would be used by virtually every owner of electric fork lifts, to offset as long as possible the replacement of a very expensive "storage device of electrical energy".

I would like to see some independent test results of the effects of EDTA on batteries. Until then, I have to consider Mr. Martin's claims with great skepticism and accept his reasoning as faulty, at best.

Monty Tarr
Catlin, IL

[This letter was accompanied by an article from the July issue of **SKINNED KNUCKLES**, a magazine of auto restoration, which makes mention of K.L. Martin's letter about the battery additive EDTA, published in the July issue of **NINES**. Mr. Martin sent the same article to many car clubs in the U.S. (It was also published in **ROLLING**, the Volvo Club Newsletter, and others.) SK says "the hypothesis put forth to explain the action of this additive is based on a very poor understanding of the electrochemistry involved in lead-acid batteries." Their recommendation is to regard Mr. Martin's claim with "considerable skepticism".

I also received a box that once contained "VX-6, Cadmium Battery Additive" from Kenneth Wyle of Waverly, IL. It carries a photo of Lee Petty, Champion NASCAR Winner, who says, "I'd rather race without tires than without VX-6 in my battery."]

TW

TOWING WITH A TURBO

An article entitled "Tow It" in the May 1987 issue of **POPULAR MECHANICS** (pps 78-80) listed a number of caveats against trailer towing while using cars equipped with turbo-charged engines. Chrysler Motors and Saab 900 Turbos in particular were singled out in their chart of towing capacities for 1987 model vehicles (and by inference earlier model years) as being not recommended for the task. A quote from the article is as follows:

"Powerful engines and heavy-duty drivetrains not only are easier to drive with a trailer in tow, but will last much longer. However,

turbos are usually not recommended since the turbo often is overworked keeping a steady highway speed with a trailer."

Since it is my desire to install on my '83 Turbo a removable trailer hitch (currently unavailable for my Saab) and perhaps tow a pop-up recreational trailer weighing in excess of 1200 pounds equipped with its own brakes across the country, the statement from **POPULAR MECHANICS** magazine leaves me more than a little puzzled. After all, the Saab accessory brochures lead one to conclude that towing trailers with heavy loads (not exceeding 2000 lbs.) would be no big deal providing the proper factory authorized and recommended equipment and procedures are used.

Seeking a clarification from Saab-Scania of America concerning turbo-charging as it's related to towing resulted in my receiving a letter from Steven Rossi (Manager, Product Development & Compliance Department, Technical Services, Saab Car Division) in which he reiterated the caveats outlined on pages 19-20 of the 1983 Saab 900 owner's manual under the topic of "Driving with a Trailer". In his letter he wrote:

"In addition, our special instructions for Turbo operation which appear on page 21 should be adhered to. As can be seen, there are no stipulations against trailer towing with Turbo models. However, if you tow for extended periods with any model, the severe service recommendations, footnoted under the Emissions Systems Maintenance Program, should be followed."

Although Mr. Rossi didn't specifically state what constituted "severe service" a careful reading of his reference (and the reference's cross reference) revealed that frequent trailer towing is considered by Saab to be a "severe operating condition" under which the engine oil and oil filter should be changed every 3750 miles or four months, whichever occurs first, instead of the usual 5000 mile interval. Common sense would probably have one changing the oil/filter even more frequently; after all, deferring a necessary turbo-charger replacement/engine overhaul because the oil was replaced sooner rather than later is bound to be less expensive in the long run over the serviceable life of the car.

A careful reading of the Service and Maintenance Schedule in the

owners manual also has an "under severe driving conditions" footnote that pertains to spark plug life which essentially states that instead of changing the spark plugs every 30,000 miles, they should be replaced every 15,000 miles. In the Specifications section of the manual under the heading "Electrical System" sub-heading --Spark Plugs-- there are listed two types of driving conditions for Turbos: normal driving where the recommended plug is NGK BP6ES and hard driving where the recommended plug is NGK BP7ES. Although the manual doesn't specifically state this I presume that hard driving qualifies as being a "severe driving condition".

Mr. Rossi continues: "Concerning the article which appeared in the May 1987 issue of POPULAR MECHANICS, I recommend instead that you follow the information published by Saab-Scania. Although a highly respected publication, I assume the editors of PM were perhaps generalizing a bit with their recommendation and obviously did not consult Saab owner's literature..."

He concludes: "From the above, I hope that you agree that Saab-Scania has indeed taken an interest in owners who wish to tow trailers. All of our performance and endurance test activities include significant trailer towing sequences. By the way, trailer towing is also quite popular in Europe since drivers there are exposed to stricter constraints concerning roof-top loading, etc. We will respond to POPULAR MECHANICS to clarify Saab trailer towing allowances."

So, I suppose, towing a trailer with my car shouldn't be too much of a problem, in spite of what the editors of Popular Mechanics have to say, providing that the recommended procedures and equipment as outlined in the Saab owners manual are followed.

However, I noticed in the August 1984 issue of the club newsletter that a Saab Service Information bulletin (03/84-672) stated: "...if synthetic of partially synthetic oil is used; follow the normal change schedule under ALL conditions except dusty conditions (emphasis added) when more frequent oil filter changes are recommended."

That statement makes me wonder what oil changing recommendations Saab has for users of synthetic oil under normal non-severe service conditions.

Gene Zagorsky
New York, NY

A TURBO FOR HEAVY HAULING

As my Saab parts business developed, I have more and more frequent need to haul parts cars and rebuildables over long distances. Since I don't have a Saab truck,

I've been building up my '80 Saab 900 Turbo to do the job. I fabricated a "front wheel carrier" dolly (ala U-Haul) with surge brakes using a 900 rear axle, and a full trailer with electric brakes for those cars too bent to tow. To handle the gross weight that is close to double that recommended by the manufacturer, I first installed a custom hitch with five mounting points to the unibody. Next I installed the intercooler and other modifications described in the Dec '86 NINES, and later fitted springs, shocks and sway bars from an '85 SPG as well as air bags in the rear coil springs.

Several months ago POPULAR MECHANICS had a writeup on trailer towing with the light weight vehicles of today. They recommended against using a turbo charged tow vehicle, because the turbo caused too much heat. True, but a turbo also makes lots more horsepower, which is very helpful when asking your 2-liter engine to pull a heavy load.

On my first warm weather trip this spring, to Minnesota, I discovered what PM was talking about. Lots of power; I could pull a 3600 pound load at 65mph at 3 to 5 psi continuous boost, but I couldn't get rid of the heat. With both fans running (yes, the electric fans help move more air even at highway speeds), air conditioning compressor lead disconnected, heater full on, windows and sun roof open, I could barely keep the gauge out of the red at 60 mph. The cooling system was in top shape, a 30 second stop at a toll booth was enough time to bring the temp gauge back to "N" (would that they still put numbers on the gauges). Some might argue that 55 is fast enough with a load, but this trip was made in 70 degree weather; 90 or 100 degrees ambient air would be impossible.

My first step was to build a larger radiator. I took the end cans from an older 99 that used a 4-tube core, about 2 inches thick (the 900 radiator is a 3-tube tuyepe about 1-1/2" thick). I had the 4-tube core installed using the 900 fittings. The hood hinge brackets have to be removed during installation and the bottom mounting pins must be moved or new holes drilled. Otherwise it fits very well, and provides approximately 25% more heat exchanger area. Unfortunately I did not have time to test this change alone to see if it would solve the heat problem.

At the same time I installed an additional oil cooler, this from a 16-valve turbo. It fits below the bumper on the left side with its own heavy duty frame/air scoop form fitted to the lower body pan. Two 1-1/4 inch holes were drilled through the body for the oil lines and then simply hook the two oil coolers in series using one

additional line from the new cooler.

The third change was due to the discovery of significant play in the turbocharger shaft (although it was working fine). I installed a new turbo with a watercooled center section, just like the new Saabs. The manufacturer provided an "H" fitting to hook into a heater hose, but didn't seem to provide much flow. I removed the large plug from the block under the exhaust manifold, drilled a 5/8" hole in it and tapped it for a 3/8" pipe. I brazed another 3/8" pipe nipple in the steel pipe connecting the thermostat housing to the upper radiator outlet, then hooked the turbo housing into the cooling system with heavy duty radiator hose. This modification does not add to the heat exchanging capability with ambient air, but it does provide a significant interface between the two cooling media, engine oil and water. This interface should even out the extremes of temperature rise in the lube oil as it passes through the turbo, as well as eliminating the problem of heat soak in the turbo and oil coking after shutdown.

How does it all work? Great! The car now runs cooler (just at "N") on a hotter day pulling another Saab on a trailer than it did previously unloaded. I just pulled a '79 EMS over 30 miles of Western Pennsylvania turnpike (lots of hills) never dropping under 65 mph or over the "N" mark on the temp gauge, cooling fans not running. In normal city traffic the fans don't come on. The engine may be slower to warm up in winter since I am bypassing a 3/8" stream of coolant around the thermostat through the turbo housing, but that is what block heaters are for (or will that defeat the block heater as well?). Sure solves my summer problem.

Dennis Sweeney
Ligonier, PA

ANOTHER SYNTHETIC OIL

Another source of high quality synthetic oil is Red Line Synthetic Oil Corp, Martinez, California, 800-624-7958. I'm using their 10W40 in an '84 900 5-speed transmission with good success. They also make a 75W90 gear lube that meets GL4, GL5, GL6 & MIL-L-2105C requirements.

Red Line oils are based on a neo-pentyl polyol ester that shows a higher tolerance to heat than diester or poly alpha olefin synthetic oils, AMS/OIL and Mobil-1 respectively.

When I first bought a Saab, my understanding was never to use anything but straight 75 weight gear lube or engine oil in the 4-speed transmission. Is the 5-speed more tolerant of 75W90 than the older 4-speed?

Pete DeRoo
Toms River, NJ

ANDREWS

INC. OF PRINCETON

EXCLUSIVELY SAAB

Blue Mann Oil Fits.	\$2.99
— Quantities of ten	2.79
Air Filters:	
— 74 99	4.99
— 75 - 87 99,900	4.99
— 85 on 16 v. 900	9.49
Thermostats:	
75 - 84 99,900 74 C	5.99
85 on N/T 74 C	5.99
Radiators:	
78 on 99	145.00
79 on 900	145.00
Lambda Sensor	
78 - 84 99,900	46.99

(Does NOT include tax or UPS)

MASTERCARD & VISA ACCEPTED

612-389-3805

3 BRICKTON ROAD
RTE. 4 BOX 247
PRINCETON, MN 55371



RADIO BOX FOR 99

The radio box to fit under the dash on 99s is no longer available through Saab, so 99 owners who want to add a radio have had to improvise. I've found a box that fits well with minimal modification. It is Renault part #77 00 664 179 from a LeCar, and has a list price of \$13.84. The black color and texture match the Saab so well that you have to look closely to see that it isn't a factory installation. You'll have to cut a little off the front with a coping saw to match the Saab's underdash contours. Then you'll need to improvise a way to attach the box to the dash. I used four small right-angle brackets, the kind you can get at any hardware store, and screwed them to the box and underdash with wood screws. There is enough room above the radio in the box for headphone jacks so the driver can listen to music while the passengers rest.

Tim Winker

PLATINUM PLUGS, AIR FILTERS & SYNTHETIC LUBE FOR A 96

Many months back in the Saab Club Newsletter, a letter stated that Bosch Platinum Spark Plugs caused fouling and were not recommended. I think the plugs got a bum rap, because I've used them in my 1969 96 V-4 for over 15,000 miles with no trouble and with smooth, consistent performance. I also use them in my 1977 Pontiac (used for bracket drag racing), and they continue to perform well after over 10,000 miles of operation.

I have also installed K&N air filters (called Filtercharger) on each of the above cars. I haven't checked the possible increase in gas mileage in the Pontiac, but the air filter alone seems to be increasing the 96 mileage by about 3-4%. And there's an added bonus in that you never have to buy another air filter. The K&N is used by many race drivers and flows over 75% additional CFM when compared to the best replacement air filter made of paper. The K&N is initially expensive (it's made of surgical gauze), but the increased mileage and non-replacement will make up the difference over the miles. K&N has a complete information packet, including test articles, and it can be ordered from K&N Engineering, P.O. Box 1329, Riverside, CA 92502.

After almost 180,000 miles on my original 96 gearbox, a shaft nut lost its torque, and the rumbling noise from the trans over many thousands of miles was misinterpreted as a bad wheel bearing. When I had the trans eventually rebuilt, the original ring & pinion were reinstalled. I had been warned that there was no way to do away with the noise (bad from 45-55 mph) but that the noise would not affect the operation and performance of the transmission. I tried all kinds of lubricants and anti-friction additives to help decrease the noise, but nothing seemed to work. Now I've found the ideal product, and I think all 96, 95, 97 owners should consider using it -- Mobil-1 75W90 synthetic gear lube. The shifting on the 96 is much easier, and the ring/pinion noise has vastly decreased. Racers swear by the performance of the synthetic lubricant, but it's hard to buy in small quantities. For those who would like to buy quart bottles, call either of the following numbers: Hoosier Penn Oil, (317) 631-5409, or Morrison Oil (Albany, GA), 1-800-331-1187.

My 96 is now approaching 200,000 miles with only the following done to the original engine: two valve jobs, two water pump changes, a new balance shaft gear, one new fan bearing.

Thomas Mudd
Saginaw, MI

900 OBSERVATIONS

On the subject of tires: The OEM Michelin MXV on my 1985 900 Turbo lasted all of 21,000 miles, with the first wear bars showing up at 19,000. They handled well and felt very stable, even in the wet, unlike the older XZX's on my old 99. Since I was not happy with this tread life (and 195/60-15 MXV's were virtually unobtainable anywhere), and expected even worse from P-6's, I chose to go with BFGoodrich Euro-T/A instead. I have over 10,000 miles on them already and they look like they will be good for 30-40,000. The adhesion and handling are still very good (at least for my driving style), and with a broad slip/break-away point and only a slight decrease in straight line stability in crosswinds in comparison to the MXV's. There is probably some difference in slip angles since the Euro T/As are not steel belted, but fiberglass.

Clarion Radio: The FM and Tape are OK, but certainly not up to \$680 aftermarket quality. The AM section is a disgrace!!! I cannot receive 50,000 watt stations from greater than 60 miles in daytime, and AM stations are still nice for weather conditions, ballgames and talk shows. I had problems with my Clarion, that got progressively worse. It began with the power antenna going up and down at free will (with the radio on), highly distorted or intermittent loss of sound from a front speaker, and finally the radio would not work at all. My local dealer's response was that he could "swap out" the radio for the cool \$680. Apparently neither this dealer nor Saab makes any effort to source approved repair shops for these radios. Nice. Figuring I had nothing to lose, I tore into the radio myself. My problem was in the small "cage" on the rear of the radio where the multipin edge connector joins the radio to the car's wiring harness. Taking apart this small cage, I found a printed circuit board with some electronic components, about a dozen small wires, and the edge connector. I found that several solder joints between the printed circuit board and the solder tails on the edge connector were broken. Resoldering these connections fixed all of the above problems. The wiring harness leads in my car were very short and had a lot of tension on them, which could have helped cause the solder joint breakage problem. I did carefully pull the wiring up in the dash to lessen the tension on the connector when reinstalling the radio. Hope this can help someone lese who might be experiencing similar problems.

900 Taillights: I have now seen three cases where taillights on 1982 4-door sedans have seemingly gone crazy. Some symptoms are; very dim

brake lights in the daytime, and with the headlights on, brake lights that actually dim while all other lights in the housing glow weakly. Yes, that includes the backup lights, turn signals, etc. The most obvious symptom is that both turn indicator arrows on the dash will light when you step on the brakes. The problem is a bad ground circuit in the left taillight. All of the lights in both the left and right taillight housings are grounded through one connector pin in the left taillight, and it corrodes, overheats and loses spring tension. The 1982 models that I have seen with the most serious problems had what appears to be galvanized (ala garbage can) steel circuit board in the taillights. Newer models appear to be Cadmium plated circuits. The taillight housings are very expensive, and I could find no replacement connectors available. The connectors are made by AMP, but are custom made, not a catalog item. However, the connector assemblies do come apart with a little careful prying (press fit), so they can be fixed in a way that requires the cutting and splicing of only one wire in your car. Go find a late model (84 or newer) wreck in a graveyard and pop out the left taillight housing like you were changing a bulb. The color of the circuit traces should have a slight yellow tinge, definitely not the pure gray garbage can color. Pull off the connector on the back of the housing and check that there is no corrosion on any of the contacts, especially on the second from the inside of the car (largest black wire). If OK, take the housing and connector, cutting off the wiring harness about a foot back. Use this newer housing in your car. Take apart the connector from the graveyard and remove one of the spade connector-like contacts. Take apart the connector still on the wiring harness of your car, removing the spade-like connector attached to the largest black wire, the second position from the inside end. Insert the "new" spade-like connector (with wire attached) into the second position and reassemble the connector. Cut out the "bad" spade like connector from your car's wiring harness and splice the wire from the "new" spade-like connector into the harness preferably with a crimp splice. Attach the harness connector to the taillight housing and you're done. This repair has been successful for over a year now. To be extra safe, you might consider cutting the ground (black) wire connection from the right to left housing, grounding it directly to the frame crossmember in the trunk floor, thereby reducing the current flow through the culprit connector. I am not aware of any recalls or service bulletins on this problem.

Headbolts: There has been much



Northwest Airlink Saab SF-340s lined up at Memphis Airport.

discussion lately on re-torquing headbolts. Does this also mean that headbolts should be replaced when installing a new head gasket, rather than re-using the old ones?

Rick Zordan
Indianapolis, IN

WILD LIFE GETS TO TURBO

One of our two '82 Turbos had been progressively losing boost over a period of a few days last fall, and I had just about run out of things to check. Since it was my wife's car, she kept urging me to check the air cleaner, but I had just put in a new one with the latest 15,000 mile service. I don't particularly like to open the air cleaner on the '82s anyhow. Jerry Danner of Mile Hi Body Shop in Denver suggested that the exhaust system might be restricted; I disconnected it at the manifold with no change in performance.

Finally I was convinced it was something in the APC system and decided to take it into Jerry's fine shop for a professional diagnosis. Once more my wife mentioned the air cleaner, so I reluctantly decided to humor her and show her that couldn't possibly be the problem.



The contents of the Air Filter canister turned out to be a major surprise. Of course, there was one almost new air filter, but surrounding it was approximately one quart of dog food pellets, completely filling the inlet pipe and packed around the cartridge!

We feed our dog in the garage right in front of my wife's car and sometimes the dish has some uneaten pellets left through the night. Rodents of unknown variety apparently moved in and decided to cache some dog food for the upcoming winter.

Maybe Saab could come up with a Rodent Screen to fit across the air intake.

Tom Nelson
El Rancho, CO



PARTS

EUROPEAN
AUTOTEILE
INC

DISCOUNT PRICES ON
NEW, USED, REBUILT PARTS & ACCESSORIES

TURBO OIL ACCUMULATOR
Cycles turbocharger oil for 60 seconds after engine shutdown. EXTENDS TURBOCHARGER LIFE!
\$142

99 SAAB HATCHBACK REAR SPOILER
Fiberglass spoiler — more effective than factory.
\$130

COMPLETE 900 AERODYNAMIC KIT
Includes front and rear spoilers and side panels.

TURBO BOOST KIT

INTERCOOLER KIT
Call for price and availability

EVERYTHING FOR YOUR SAAB!

1311 67th ST. • EMERYVILLE, CA 94608
(415) 654-9121

NINE-T9



NINE-T9 Before

Here at Saab Club headquarters, we often get letters asking "How can I improve the performance of my 99 (or 900)?" I often suggest that the reader contact one of our advertisers, or look back on a particular issue of the newsletter. Several good articles have been written on performance modifications for these cars, but they have been scattered through the various issues, and not collected into one series. I have decided to remedy that by building the NINE-T9.

The intent of this project is to show how to build a reasonable performance machine, not a screaming Swedish hot rod. The modifications are being done to a normally aspirated car, as a turbocharger already gives plenty of power, and several recent articles have dealt strictly with Turbo accessories such as intercoolers.

It is also a demonstration of how you can put together a potent street cruiser/autocross competitor for less than the price of a new car. This is assuming that you start with a vehicle in the \$2000-\$4000 price range, about the amount of a down payment on a new 900. All of the accessories are strictly bolt-on, no special machine work or skills will be needed. You should be able to do any one, or several, of the operations in an afternoon. And they will be applicable to both the 99 and 900.

The project begins with a car that carries some of the attributes of both the 99 and 900, a 1979 99GL. (Beginning in '79, the first year of the 900, the 99 was fitted with the same rear suspension as the 900. Mechanically, the 99 and 900 are virtually identical.) The car has a solid body (a few parking lot dings and a rusted left front fender which had been replaced in an earlier accident), a sound engine (recent valve job, water pump, timing chain, and regular oil changes), and a clean interior. In the year I've had the 99, I have made a few changes to make it more to my liking.

TACHOMETER -- The tach from an EMS fits easily into the instrument cluster space occupied by the clock. (Saab P/N 85-31-170, List \$371.50) (The tach/clock, leather steering wheel, and road wheels came from a rusty '76 EMS bought as a parts car. Other items worth saving from an EMS include the steering rack, Bilstein shocks, springs, and interior, if they're any good.)

To replace the clock with the Saab tach, remove the screws holding the dash padding, then slide the padding toward you. Next, remove the screws holding the instrument cluster, and

pull it out. Take care when disconnecting the speedometer cable(s) and electrical connectors. The clock comes out by removing several screws with 6mm heads. The wiring for the tach is already in place behind the dash, it is just a matter of connecting the wires (yellow and brown, see the wiring diagram in a Saab repair manual for more help).

STEERING WHEEL -- When I bought my 99, it had a late model 3-spoke vinyl steering wheel; very nice. The leather EMS wheel is not in as good shape, but there's nothing like the feel of real leather. There are cheaper wheels (Formuling), and nicer, more expensive wheels (Momo). A good case of "Ya get what ya pay for".

HEADLIGHTS -- Cibie H-4 Low/Hi beams and H-1 High beams. The difference in using a quality set of halogen headlamps is amazing. I won't own a car without them.

EXHAUST SYSTEM -- The muffler and tailpipe were replaced with like pieces made by Prima Flow. The muffler bolts on to the existing center pipe and uses the stock mounting hardware, it is heavier gauge steel than OE, and Prima Flow claims better exhaust flow, hence a little more horsepower. The tailpipe also has a chrome tip.

BRAKES -- The brake pads were upgraded to Saab's latest recommendation (see S.I. 07/86-861, Oct 86 NINES). We used Repco Metal Masters (#226M) for the outer pads and a dual friction compound (#226) for the inners. They work very well with no brake squeal problems.

SUSPENSION

Any increase in horsepower won't do a bit of good if the suspension isn't up to the task. So before doing any work under the hood, the pieces nearest the ground got attention first.

SHOCK ABSORBERS -- There are many performance shocks on the market; Bilstein, Koni, Sachs, Tokico, Boge... I wanted better than stock, but didn't want the harsh ride of an all-out racing or rally shock. The choice was KYB Gas-A-Just, about \$30 apiece. The ride is as expected, up to the task when I'm driving hard, but reasonable for daily use. Make sure you support the rear axle on each end when you are removing/installing shocks to avoid bending the axle in the middle.

WHEELS -- Aluminum, definitely, for lower unsprung weight as well as looks. One of the most readily available wheels for the 99/900 is the EMS soccer ball design (see the Saab Swap in almost any issue of NINES). The wheels were straight

but badly corroded. Many hours with steel wool and aluminum polish brought back much of the shine, but some pitting still exists. They will get painted to match the car at a future date. Due to a slight difference in hubs on '79 and later models, the EMS wheels needed to have the centers machined a bit to fit; \$50 at a local machine shop. Alternatively, these wheels may be replaced by newer 900 alloys.

TIRES -- A good way to utilize the torque of the engine is to change the final drive ratio. The cheap and easy way to do that is to go to a smaller tire diameter. You lose a little at the top end, but I don't much drive over 80mph. I wanted to swap the 165/80SR15 Michelin XZX's for a set of 185/65x15's, a drop of one diameter size, and several sizes wider. (An alternative would have been the next widest size, a 195/60x15.) I turned to Wayne Anderberg at Hiawatha Tires Plus in Minneapolis for a recommendation. I've known Wayne for many years (we worked together at another tire store ten years ago, along with Mark Strohm who now runs Swedish Express in Duluth). He likes fast cars, and keeps up on the latest tire trends for performance use, so I respect his judgement.

Among the suggestions were: Michelin MXV (H-rated) or MXL (S-rated), Pirelli P-8 or P-600, Goodrich Euro T/A, or Bridgestone HP41. The Michelin and Pirelli H-rated tires are Original Equipment on Saab, and are not always readily available. In addition, Pirelli tires seem to have "cupping" problems after about 30,000 miles. The Euro T/A is a nice tire, good in the wet as well as dry, but Wayne says they are very heavy, which doesn't help when you're trying to reduce unsprung weight. Bridgestone's HP41 is a new design H-rated tire that uses Potenza casing technology. Bridgestone calls it RCOT, Rolling Contour Optimization Theory. This method of building tires is used currently in Bridgestone's 300-series tires; the tire is pre-stressed meaning it doesn't have the usual "squat" of a radial tire. The result is a firmer footprint and better ride. Unfortunately, the HP41 isn't on the market yet.



I ended up with a set of Kleber C4T's. They are a "T" rated tire (118mph), available at a low price, so an appointment was made to put them on the NINE-T9. "T" is a new rating between the standard "S" (112mph) and "H" (130mph) speed ratings (see SPEED RATINGS OF TIRES, June 87 NINES). I wasn't too crazy about going to an "H" or "V" rated tire as they are usually more expensive and tend to wear out faster. A "T" rated tire fit both the categories of economy and performance nicely. A drawback of the shorter tires is that the speedometer now has a 5% error.

One other item that deserves mention is the machine used to dismount and mount the tires. Most tires shops still use a tire mounting machine where the bar slides on the outer rim of the wheel. In proper hands, and with precautions, this method is acceptable for most wheels. Hiawatha Tires Plus uses a Coates RC10A which clamps to the inner side of the wheel rim, not the center hole, and removes the tire with a roller setup, without dragging on

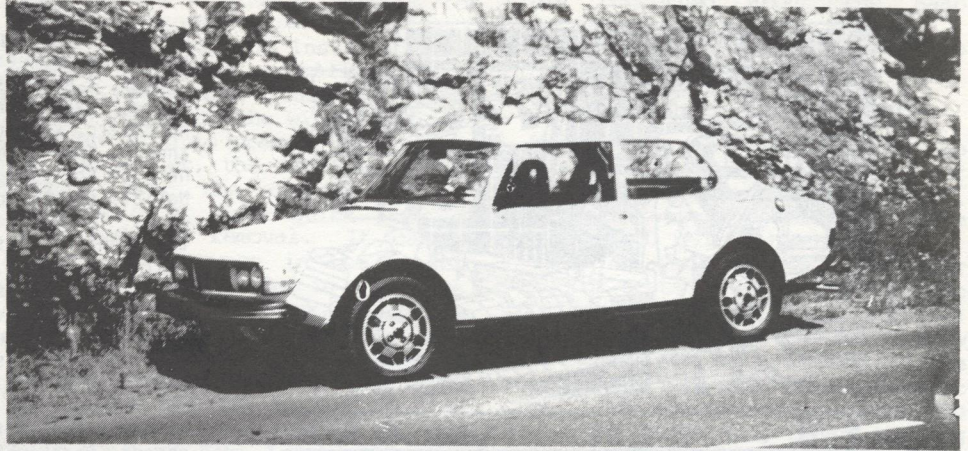
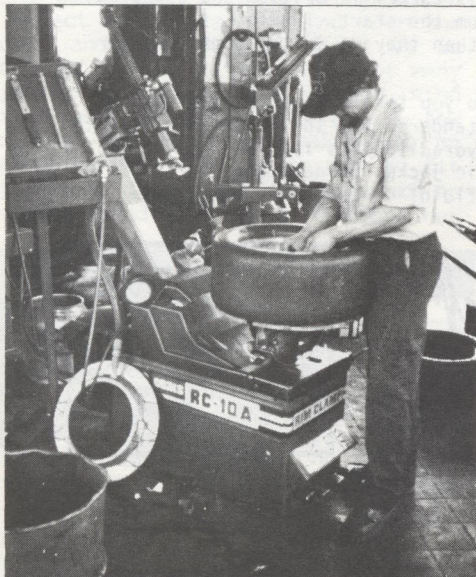

NINE-T9 Today

the outer rim. Consequently, the tire bead does not get torn, either. These newer machines are more expensive, but you know a shop that has one is concerned with quality service for their customers.

A good way to complete the suspension would be a set of Sway bars, or more properly, Anti-roll bars. There are a few aftermarket companies that list bars for the 99 and 900, and I may still add a set. I have seen installations of ADDCO and H&H bars, and I prefer the H&H mounting system which bolts directly to the suspension instead of using connecting links.

The NINE-T9 recently had a new paint job in the same Alabaster Yellow factory color. Dings and rust spots were fixed, and black plastic trim from a Turbo was installed around the wheel openings for protection. A striping scheme is now being considered; reader input is welcome.

This completes Phase I of the NINE-T9 project. Next time, we'll go under the hood and start to make improvements there. Plans are to add a Weber "Big Throat" F.I. throttle body and a streetable camshaft. Any other suggestions will be appreciated.

SAAB FACTORY PARTS AND ACCESSORIES CATALOGS

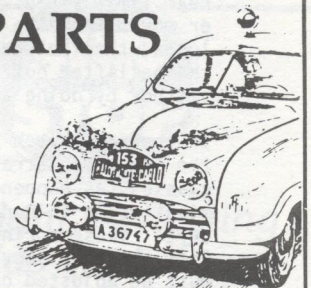

V-4, 99, 900, 9000\$5.00

EXCLUSIVE V-4\$3.00

EXPERIENCED, KNOWLEDGEABLE
SAAB OWNERS RESPONDING
TO YOUR REQUESTS

ROWLAND INC. MOTORS

" THE
ENTHUSIAST
SOURCE "

517 E. Pike Street
Seattle, WA 98122

USA 1-800-426-2202
WA 1-800-562-5510
SEATTLE 206-328-2303

Established 1920

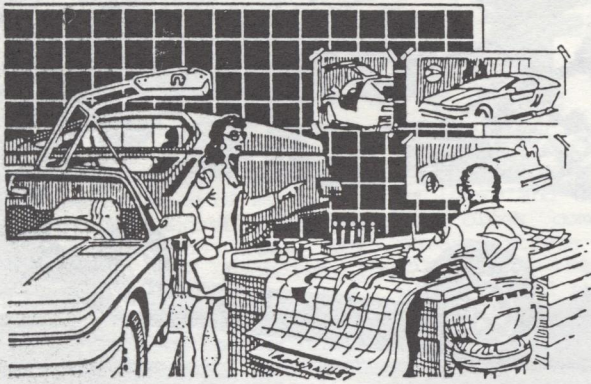

SHIFTIN' GEARS

by JACK ASHCRAFT

The age of the early SAAB 95-96-97 series is showing, often in interesting ways. Some of the age problems are manifested in what the engineers term "fatigue cycle", that period of oscillations that a particular part is designed to withstand. For example, if we consider a SAAB 95 wagon for this article, fatigue cycle items I have encountered recently (or more accurately, those items that are at or near the END of their cycle) include springs --suspension and otherwise. Sagging or weak front springs can be replaced easily and safely using the SAAB spring compression tool. Rear springs usually don't require replacement unless the wagon has been habitually used as a heavy hauler, but if they need it, no compressor is required. You just jack up the rear end of the car and block it with jack stands at the side jacking points, loosen the rear limit straps, remove the bottom shock absorber mount from the axle and pull the shock link loose, then let the axle free-fall. The springs can be lifted out and the replacement prings re-fitted, by doing the above steps in reverse order.

If the rear hatch lid falls down and bangs you in the forehead, scratches your nose and breaks your glasses (as happened to me) you know "dere is sumting rotten in Denmark" in der spring department dere. These springs (one on each side) that help lift the rear door have stretched or broken and must be adjusted or replaced. The improved figure from the Saab shop manual shows the location of the spring. It's easier to adjust if you take the upholstery out but it is possible to do if you just remove the small upholstery panel where the flow-through vent is located. A pair of 7/16" open/box wrenches plus a small vise grips (to prevent the spring from rotating) are all the tools required.

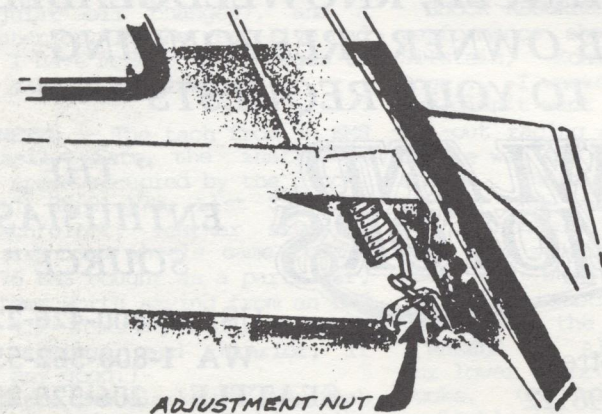

Dave Mondecar (Apr 87 issue) asked about strange noises in the rear of a 95 and traced it to brake cables. I have found several 95s with a strange "clunk" back there, evident when going over pot holes, etc. Everything seems tight EVERYWHERE back here. Take a look at the parts manual drawing here of the rear shock absorber and its mounting. Not all shocks mounts are made as this diagram shows. Indeed the bolts that mount the shock to the mounting plate (which I have labeled #9) are just that: BOLTS. Not studs as shown here. Also they tend to loosen and allow the shock to shift on the plate, giving you a good audible "clunk". Solution is to remove the tire and rim, and remove the entire shock assembly. Unbolt the shock and clean up the bolts, apply some lock-tite to the threads, put the shocks back in place, put on the nylock nuts, and torque to 42-48 foot-pounds. Reassemble, making sure you have a tapered rubber bushing on each side of the mount plate at the mounting holes.

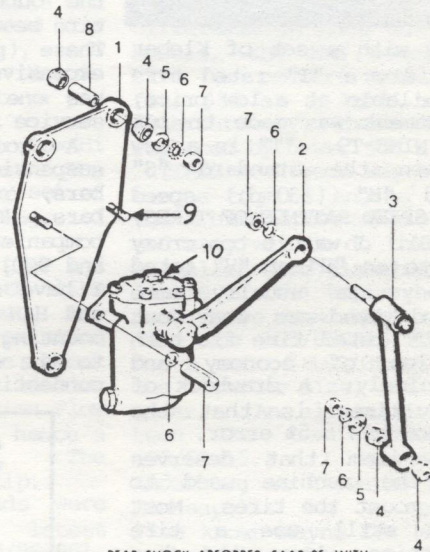

REAR SHOCK ABSORBER, SAAB 95 WITH CONNECTING PARTS

While we're on the subject of rear shocks, it is interesting to note that Saab also recommends the rear shocks to be "topped up" with hydraulic oil "of good quality" every 12,000 miles. You can do this by removing the rear tire and rim, cleaning the top of the shock carefully, and loosening the big nut (labeled #10 in the diagram), removing same, and filling up the reservoir. You have to remember that this turkey is British and expected to leak a bit from the start. The fact that they don't leak more than they do is the eighth wonder of the world.

It might occur to you to add a bit heavier hydraulic fluid than standard. You should be able to get a selection of hydraulic oils from any outfit that services hydraulic jacks. Do note that is is NOT hydraulic brake fluid!

Jack Ashcraft

86 Ford Tempo update:
Air Cond Failed 9100 Mi.
Fixed same day by Ford
dealer. I still rate it
equal to the Saab 900.
Stay Tuned!

NEW PRODUCTS

KEEPING COOL WHILE PARKED

We've all had the experience of leaving the car in a parking lot on a sunny day, and when we return the air inside is nearly unbreathable. The interior of your car, with the help of the sun's rays, has turned into an oven, as much as 50° over the outside temp. For the car's occupants, it means a bit of discomfort until the windows are rolled down and air is allowed to circulate, or until the air conditioning can lower the temp. For the car's interior, it can mean a cracked dashboard, faded upholstery, or even sagging headliner.

You can tint the side windows or put louvers over the rear window, but the windshield remains a problem. Most dashboards are black to absorb sunlight and not reflect on the inside of the windshield while driving. As we all know, black absorbs heat. Which heats up the interior and the vicious cycle continues.

Several companies have recently been marketing sunlight screens to fit in the windshield to help keep interior temperatures lowered while parked. The most common are made of cardboard and have cute pictures of Garfield or sunglasses, or cute sayings like "Life's A Beach!" That's all very fine in a Chevette or a Toyota, but you drive a Saab. You'd like to keep it nice, but a piece of decorated cardboard is just plain tacky in a high-priced car.

Enter Glenn Lacey of Sun Products and the Sun Stop screen. The Sun Stop is made of a metallic rip-stop nylon, similar to a "space blanket". The gold metallic side faces out to reflect the sun's rays and keep the dash and seats cool. Since it is made of nylon, it will last for many years, unlike the cardboard kind that are probably good for a few months. The Sun Stop also has an advantage in that it is cut to fit the Saab windshield, so there are no gaps around the edges. Lacey has

been making a similar product for small airplanes for several years.

The Sun Stop is installed with Velcro fasteners. Small adhesive backed disks are attached directly to the inside of the windshield, and the Sun Stop is pressed into place. In the winter, the Sun Stop can be placed over the outside of the windshield to make quick work of snow and ice removal. It can be folded for stowage in the plastic pouch that is included in the price.

How well does it work? Very. On some recent days with outside temps in the mid-80s, the interior stayed in the 90s. Without the Sun Stop, the inside temp got as high as 120°. It is particularly helpful if your Saab does not have A.C. as it takes less time for the interior temp to match the outside after the car has been parked in the sun for hours. Since Saab is known for its "greenhouse" for outward visibility, it's nice to have something to combat the negative effects of all that glass.



Saab

9000 MODELS FROM CORGI

Corgi Toys of Great Britain has included the Saab 9000 as one of the models in its "Turbos" series. Their 1/43rd scale models come in two colors, white or red, with numbers and sponsorship decals, like a good race car needs.

The series is obviously aimed at the youngsters and not the serious model collector. The striping is usually crooked, the paint is often missing on the edges, as though the model was packaged before it was dry. But the price reflects that. I found these at a local KayBee Toy Store for \$2.29 each. Corgi's part numbers are CB106 and CB107.

NEW ROWLAND PARTS CATALOG

Last year I reviewed Rowland Motors parts catalog for 96s, 95s, and Sonetts. Rowland has recently published a new catalog that includes those cars plus the 99, 900, and 9000. It is much bigger, and again lists only some of the "fast moving" parts. Rowland carries plenty of other Saab parts (they are a Saab dealer after all), including many parts that are not available through the regular Saab dealer network.

Rowland's Parts Manager, Rich Roberts, is a Saab fanatic who drives a 96 and likes racing and rallying. So he searches for parts for the older cars, and for performance parts for competition or street. His interests, and those of his employer, make for one of those rare animals... a Saab dealer who is

truly concerned about the Saab owner.

See Rowland's ad in this issue to order their latest catalog.

"CUSTOM" RADAR DETECTOR?

While at my local Saab dealer the other day, I noticed a display for "The SA-200 Remote Radar Detector". The brochure was identical to those for the K-40 radar detector.

Those of you who read the Radar Detector tests in the big automotive publications (Road & Track, Sept 86; Car & Driver, April 87) will know that the K-40 detector is little more than a BEL unit in a different case. BEL Electronics markets the Micro-Eye brand of radar warning systems. As far as I know, the only real difference between a Micro-Eye remote detector and the SA-200 is the Saab logo and the price. The SA-200 is vastly inflated since it is "sold exclusively through Saab dealers", and allows them one more expensive option to tack on to your new Saab.

Your best bet is to look for a Micro-Eye or other top rated remote detector. (A remote detector helps eliminate theft. Escorts and Passports are popular with thieves because they can be grabbed quickly and peddled easily.) Though the SA-200 may well be a good detector, and it should be if it's using BEL electronics, you'll be many dollars ahead to look elsewhere.



Sunlight Reflecting Shields That Keep Your Car Cool!

- Sun Stop installs in seconds to the inside of your windshield.
- Reduces interior temperatures in parked and locked cars.
- Attractive metallic ripstop nylon fabric keeps dash and seats cool while preventing fading of upholstery.
- Stores in its own neat pouch when not in use.
- Custom fit for your car and guaranteed.

State make, model and year.

\$39.95 includes postage and handling (CT. residents add sales tax).

Send check to:

SUN PRODUCTS, INC.
P.O. Box 202
Middletown,
CT 06457

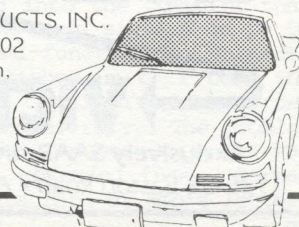

— 87 CONVENTION MEMORIES —

T - Shirts — 100% Cotton, L & XL
Features 5 Saabs, 92 thru 9000 \$8.00

Posters — 92 and 9000
With Old and New Logos \$2.00

— Video Tape Coming Soon —

ADD \$2.00 POSTAGE & HANDLING PER ORDER

TULSA SAAB CLUB

c/o RAY KURR
405 W. MIAMI
BROKEN ARROW, OK 74011
(918) 451-2899

Some of the cars at the 1987 National Saab Owners Convention in Tulsa, OK, at the Concours and on the Gumball Rallye.

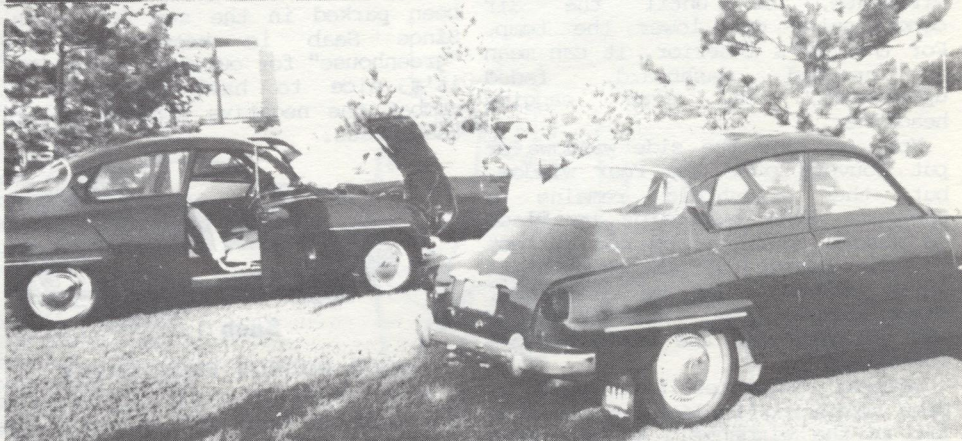

(312) 489-SAAB

SERVICE ABOVE AND BEYOND, INC.

- Quality Service
- New and Used Parts
- Transmission Exchange



1512 N. Throop • Chicago 80622

Exclusive SAAB Parts Center

The area's most extensive inventory at competitive discounts.

(215) 886-8660

Free delivery or UPS

SAAB

VICTOR

Exclusively SAAB since 1958.

1125-35 Easton Road • Abington, PA

STEERING SYSTEM REPAIRS

The power steering pump on 900s & 9000s is of a General Motors type. Eventually, the pump seals break down and allow fluid to seep into the canister. This causes pitting and poor steering assist. Eventually the leak becomes enough to be visible outside the rack and pinion gear. At that time, replacement with a new unit is usually required. However, MOOG Corp. rebuilds these pumps and sleeves them with stainless steel. Practically indestructible. This is time consuming and costly, but cheaper in the long run because the unit is strengthened, alleviating multiple replacements. The unit is bench tested after rebuilding, before being sent back to the customer or shop.

Don't try to save money when having ball joints or tie rods repaired or replaced by reusing the CV-joint boots. Spend a little extra to be safe and have new boots put on. The boots that are advertised nationally as a DIY project will serve in a pinch, however they come with one side slit open. After slipping them over the joint, you need to seal the opening with a special adhesive and this has to harden in a controlled area with no less than 65° F. for 6 to 8 hours. It is much better to use OE type CV boots.

Inspect your CV boots periodically by turning your wheels to the limit of left and right. Wipe the boot and pinch each fold of the bellows and check for cuts, small holes, and leaking grease. Replace leaky boots as soon as possible since moisture and dirt getting into the CV joints can quickly destroy them.

(I recently passed a MOOG Front End and Alignment Clinic. If you have any questions about Saab front ends, call or write to me)

Margrit Adler
1507 W. University Av.
Champaign, IL 61821
(217) 356-9244

REAR WIPER KIT TROUBLES

Thanks for the very timely article regarding the rear window wiper for the 900 hatchbacks in the June NINES. My wife and I had just taken delivery of a 1987 900S, and we'd paid an extra \$400 to have the wiper kit installed. After reading the article I realized that the system on my car was not operating as advertised. The dealer, per factory instructions, had wired the switch for the rear wiper into the front wiper system. The rear wiper was always on whenever the fronts were. In light rain, this meant a constant squeaking on a nearly dry rear window. I do a great deal of driving for work, and it was annoying to listen to this for two hours or better.

After calling [NINES' editor] to

verify the accuracy of the newsletter's data, I returned to the dealer to have the rear wiper rewired. It seems that the harness the factory provides will only reach to the center of the dash and that the factory recommendation is to wire the kit into the front system whenever there are no more open switch ports, as was the case with my "S". After a short discussion, the service manager agreed to splice a harness into the existing one which would enable the switch to be installed, even if it meant placing it under the headlight switch.

The result was quite favorable! The wiper now pulses three times after actuating the switch and there is no more extra noise to deal with. They also installed the extra washer pump that was with the kit which now means I no longer have to run the front washers for 30 seconds to wet the back window. I would highly recommend to anyone interested in purchasing the rear wiper kit to check with their service department first on their installation technique. \$400 is quite a price to pay for a rear wiper and not have it work as designed.

Other thoughts on the new "S"... the refinements made since we bought our '79 900 EMS are fantastic. The power steering, brakes, windows, and door locks spoil you. The handling is much improved. I've pushed it hard more than once, yet have not reached its limits. I do notice the power band on the 16 valver is at the high end. It's a little slow off the line, but really pulls hard from 3500RPM on up.

Our "S" has the new passive restraint system. It seemed a little strange at first but has now become very convenient. A by product was the new seats which are quite comfortable and adjustable while you drive; very nice on a long trip.

The only glitches are a notchy shifter at low RPMs, some exterior panels and interior trim, rugs, etc. are not fitted as well as they should be on a car of this price. Even so I'm still very pleased.

Mike Brown,
Hatfield, PA

96 SEAT REPLACEMENT

If your 96/95 V4 seats are split badly or you're tired of vinyl, try 99 seats. The rails are the same width and with a little creative hacksawing you can remove the driver's special brackets as well as the end stops. Grind or file smooth, then just drill the rails to match the 96 brackets and bolt down with some 5/16" bolts. You may want to use the wedge shaped spacers from the 96 seats to tilt the 99 seat bottoms backwards. These seats are lower and headroom is amazing. A good 99 rear seat can be skinned and the upholstery is fairly easy to apply to a similarly skinned V4 rear seat -- the effect is extremely convincing. The fully adjustable

SAAB



- Giant Killer Sonett V4
- Striking Viking 9000
- Made in Trollhattan (Troll)
- Go Yump a Swede (Rally 99)
- Old Saab-ers do it W/2 Strokes
- My 1st Wife... Was against rallying

The shirt is a Screen Star Best. Pick your shirt color, size, and the print. Shirt colors: Lt. Blue, Yellow, Aqua, Pink. Adult sizes: S,M,L,XL. Youth 6-8, 10-12, 14-16. Price \$8.00 (Add \$2.00 shipping per order.)

Tell Tees

547 Main St. Tell City, IN 47586

front seats are great for that much needed nap.

Robert Allen
Hamden, CT

DEALING WITH FUSE CORROSION

The Super FybRglass Eraser made by Rush is the best thing I have ever seen for cleaning electrical contacts. I've used it on lamp bases and sockets and on fuses. You can get them at stationery stores.

Wayne Hadland
Moss Beach, CA

Up until '84 models, all Saabs used open ceramic fuses. Whenever any electrical component stops working, these fuses are the first suspect. The fuse may look OK, but look for minimal corrosion at the critical contact areas. I'm amazed at the number of problems related to these old world fuses. In a pinch always try wiggling the fuse for a non-functioning component. I had bad static on the stereo traced to an arcing corroded fuse that still allowed the fan to run. Also, it won't hurt to tighten the grip on a fuse by bending the holding terminals in a bit.

Several companies make stainless steel ended glass replacement fuses, which are excellent. Disconnect the battery ground, pull the fuses one by one and use the appropriate sized twist drill, by hand, in the holes at each end of the fuse socket. A Dremel bit shaped like a small countersink is good too. Replacing one by one, check that the proper amp fuses are used.

Robert Allen
Hamden, CT

[No sooner had I finished typing this article into the computer than I noticed the turn signals on my 99 were only semi-functional. Suspecting a bad flasher unit, I took the car down to the local shop to replace the flasher relay. The problem wasn't in the flasher unit, it was caused by a corroded fuse. Reread the first paragraph of Rob's letter.

TW]



NEW DISTRIBUTION CENTER OPENS

A new parts distribution center, built by Saab-Scania of America to serve its eastern and southern regions, was scheduled to open in Meriden, Connecticut on August 17.

The new center, on a 165-acre site, will serve 175-180 Saab dealers in Saab's eastern and southern regions and will also be stocked with parts and accessories for Scania Class 8 trucks and Scania transit buses operating in North America. Meriden is approximately 20 miles south of Hartford.

Combining 136,000 square feet of warehouse space with 8,000 square feet of office space for administrative support personnel, the distribution center was officially turned over to Saab-Scania on July 1 by C. H. Nickerson, of Torrington, Connecticut, major contractor for the building.

Saab began moving stock from its Orange distribution center on July

13. Approximately 30 trailer truck loads of material per day are being moved from Orange to Meriden. All stock is expected to be moved by August 16, with the center fully operational by August 17. Approximately 70 employees will operate on a two-shift basis.

Inside the distribution center, 14 storage racks measuring 27-feet high by 210-feet long will hold thousands of numbered parts and accessories required to support Saabs in both regions.

Eight 9-foot high by 40-foot long carousels holding smaller parts and faster moving accessories will feed into a 1100-foot long conveyor belt system moving these items to packers who prepare them for shipping.

There are also five shelves measuring 27-feet high by 50-feet long for storage of slower moving parts.

As a part of the parts storage system, cranes guided by wires

From the latest
SAAB SOUNDINGS
(Copies of Saab Soundings, Vol. 25, #1, are available by sending two 22-cent stamps to the Saab Club.)



AN ERA ENDS

After 18 years and more than 614,000 cars, the Saab 99 went out of production this year. The car was a success from the moment it was launched, with almost 20,000 built in its first full year of production in 1969. After the launch of the Saab 9000, the 99 was redesignated the 90.



STAMP OF APPROVAL

The Swedish post office has issued a 25-kronor stamp honoring the SF340 turboprop airplane.



Genuine SAAB Parts
at
Discount Prices

JACK SAFRO

TOSA IMPORTS
6102 WEST NORTH AVENUE • MILWAUKEE, WI 53213
1-800-242-2003 1-800-225-2528

embedded in the center's floors will traverse the aisles between the center's racks. Operators on the cranes will need only to move down the aisle and to raise or lower the crane to pick a specific part from a particular bin.

Shipments of parts and accessories will enter and leave the center through 15 bays, designed for safe loading and unloading of truck cargo. Called Dock Loks, the devices attach themselves automatically to the rear bumper of a truck to prevent it from accidentally rolling away from a loading dock, should a driver forget to set the handbrake.

One specially designed loading dock will be used by Saab dealer personnel. The dock includes an elevator which can be lowered or raised to accommodate vehicles of various heights such as vans or cars to load them more efficiently.

99, 900 & 9000 Parts, cont.

Used 900 parts, approx 5k mi, factory Turbo front air dam, \$90. Saab rubber floor mats, black, 4pc set, \$25. F&R Koni shocks, \$80. Homemade fuel press. gauge, \$25. Fuel injector, \$12. J.V. Miniatas, 9700 Windsor, Overlnd Pk, KS 66206. 913-648-7758.

Parting out '74 99EMS 2dr, 75k mi, 4-spd trans, \$350. Hood, \$50. All in good, clean, sound condition. K. Hopp, RD#1, Pottstown, PA 19464. 215-469-6459 eves.

Factory Intercooler w/intake pipe & air bottle, \$250. Calloway intercooler, larger than stock, \$250. '78-80 turbo exhaust manifold, \$200. Tom Burton, Montague, MA. 413-774-4515, nights 774-3260.

Rear deck shelf from '86 9000T, tan. Includes Phillips series 2000 woofers & mid-range, plus high-rise tweeters. \$250 +exch for new shelf. Bruce Berlinger, 6 Baysite Ln, Falmouth, ME 04105. 207-781-2833.

4 15" Steel-belted radials, \$150. Other 15" tires & wheels, steel & EMS alloy. Many other parts, write with needs. Kenneth Wyle, 251 W State St, Waverly, IL 62692. 217-435-9777 eve & wknds.

Windshield from '82 900, no cracks, stone nicked, \$50. Mike Rand, 122 E284, Willowick, OH 44094. 216-585-1288.

WANTED, ALL MODELS

SAAB sales brochures, posters, manuals, parts books, promo items... the older & odder, the better. Also want correspondence from other collectors for trading. Rob Allen, Hamden, CT. 203-248-8798.

5-door 900 in top condition, loaded, Turbo OK. Also want one good Pirelli CN-36. Jay Hansen, 1028 Par 4 Cir, Kalamazoo, MI 49008. 616-323-4123 days, 382-4195 eves.

3/4 cam & steel timing gears for V4. Dean Nelson, 2090 Oakwood Dr, Moundsview, MN 55112. 612-780-9762.

Backup lens for '68 95, round. Blue wheel centers for Sonett III. Rear hatch latch cover for S-III. Rt front side marker lens for S-III. John Hurd, 1219 Eldorado, Kalamath Falls, OR 97601. 503-884-1733.

Complete wiring harness wanted for '73 Sonett. Will Heinzmann, 38560 MacIntosh Ct, Mt Clemens, MI 48043. 313-463-0639 or 313-465-3466.

Backissues of Saab Club Newsletter to complete Club's set. Need all prior to 2/75, plus 10/76, 2/77. Copies OK. Tim Winker, 218-724-1336.

Repair manual for 78 99EMS. Terrance Tobias, 26 Constable Ln, Columbia, SC 29223.

Window trim strip, metal & rubber, for '77 3dr, Rt side, bottom. Martin Berger, 1868 Selma Ave, Youngstown, OH 44505. 216-746-6897.

850cc engine & good front seats to fit '66 96 Monte Carlo. Erika or Tom Nelson, PO Box 25, El Rancho, CO 80401. 303-526-9138.

Rear headrests, green, wanted for '79 900. Also need RF T/S lens and bumper filler strip for '78 99. B. TenCate, 4020 Allen Rd, Tecumseh, MI 44286. 517-423-6155.

TULSA CONVENTION

Cont. from page 1
past the Philbrook Art Center, the Thomas Gilcrease Museum of Western art, and Oral Roberts University.

Legendary Saab rally driver Erik Carlsson was the guest speaker at the Saturday evening banquet, explaining why Saab is no longer involved in World Cup Rallies, and telling tales of what it was like to drive in last October's "Long Run". Saab-Scania's Director of Corporate Communications, Len Lonnegren, spoke briefly about the most recent NHTSA crash test of a Saab 9000, in which the 9000 fared very well. The evening wrapped up with an entertaining auction of Official Convention goodies (one of those "Ya hadda be there" events).

The Delaware Valley Saab Club has volunteered to put on the 1988 National Saab Owners Convention in Wilmington, Delaware. It will be held in conjunction with the 350th Anniversary of the settlement of Swedish and Finnish immigrants near Wilmington.

CRASH TEST

Cont. from page 1
vehicles are manufactured and equipped, or due to slight variations in test conditions."

After the 1986 crash test of a 9000 Turbo indicated potential injury criteria in excess of NHTSA guidelines, Saab-Scania of America declared the results invalid due to human error, and not representative of the crash worthiness of the 9000. The 1987 results appear to reinforce Saab-Scania's position.

The 1987 NHTSA test results are printed below.

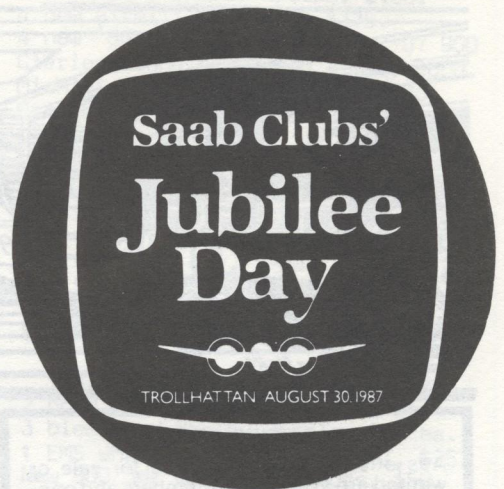

SAAB JUBILEE

Cont. from page 1

Saab films shown throughout the day. There is a live stage show beginning at 10am and repeated at 4:30pm, which features Swedish performers and a talk by Rolf Sandberg, Deputy General Manager of the Saab Car Division.

The activities move to the airport next to the factory at 1pm with an Air Show of veteran and new airplanes, followed by a parade of historic Saab cars from the factory museum.

A few final notes for those who plan to attend the festivities in Trollhattan: You must contact Paul Florance for a pass to ensure admittance to the Saab Clubs' Centre. If you are planning to pick up a new Saab through the IDS program on Saturday, let Paul know that as well. He would also like to know how many plan to attend the "Final Night In Sweden Dinner" to be held in Stockholm on Sept. 11th. The dinner is being arranged by the Club Sonett Sweden, and will include a harbor tour of Stockholm by night. Send him a stamped, self-addressed envelope for passes, a commemorative decal, and final details on the Saab Jubilee Celebration. Paul can be reached at:

126-1/2 Main St.
Seal Beach, CA 90740
(213) 493-6707.

	1987 NHTSA Test of Saab 9000 at 35 mph	Maximum Permissible Injury Criteria at 30 mph
Head Injury Criterion (HIC) driver/passenger	584/440	1000/1000
Chest deceleration (G's) driver/passenger	37/35	60/60
Femur load (lbs) driver - left/right	120/346	2250/2250
passenger - left/right	435/638	2250/2250

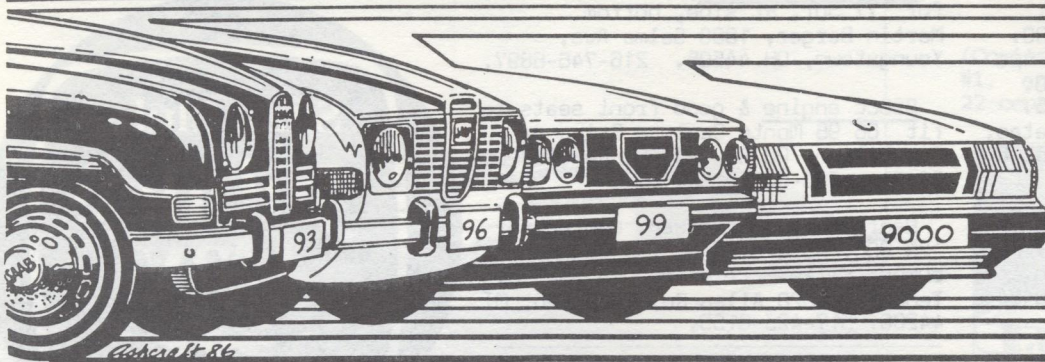

SAAB SWAP

CLASSIFIED ADS

CLASSIFIED AD RATES

Ads offering parts or Saabs for sale or wanted are available to members and non-members. Ads are limited to 25 words, plus name, address, and phone number. Ad copy will be abbreviated and excess words deleted where possible. Enclose sufficient funds with your ad, we will not bill. No ads will be taken by phone. The Classified ad rate is based on the total dollar amount listed in the ad.

Under \$200	Free
\$201 to \$900	\$2.00
\$901 to \$2000	\$5.00
Over \$2001	\$10.00
Ads without a price listed ...	\$10.00

DEADLINE: Second Friday of each month for the following month's issue, i.e. the second Friday in January for the February issue.

COMMERCIAL ADS: Contact Editor for rates and info. Deadline, First Friday of each month for the following month's issue.

MISCELLANEOUS FOR SALE

Quantum Formula Saab vintage race car. Immaculate pro restoration by Barber/Saab mechanics. Many extras, info package available. \$15,000 obo. Scott Olson, 101 Whiting St, #3-J, Winsted, CT 06098. 203-379-0194.

'69 Sonett V4 prepared for SCCA GT-4. Dual port exhaust & heads. '87 record: 2nd & 3rd at Rockingham. Mike Tucker, 2324 Davis Dr, Matthews, NC 28105. 704-846-4098.

Bosch injector cleaner & tester, new, commercial type, \$150. Kenneth Wyle, 251 W State St, Waverly, IL 62692. 217-435-9777 eve & wknds.

Saab literature, '66-'82. Large selection of brochures, road tests, post cards, etc, \$1 & up. Over 100 different posters (no Sonetts), \$5 & up. Send \$1.00 for complete list. Steve Vories, 310 S.E. 6th, College Place, WA 99324. 509-529-5334.

SONETTS FOR SALE

'74 Sonett, 45k mi, engine/trans/body/interior all very good. Some rust at rear pan. \$2500 obo. Charles Rappalje, 110 S. Willow St, E. Aurora, NY 14052. 716-652-9617.

'74 Sonett, one owner, have orig window sticker, solid chassis, correct wheels, easy restoration. \$2600 obo, partial trade w/cash considered. Also have Sonett parts including a solid chassis & alloys. Bill Cook, Comstock Park, MI. 616-784-4614 after 6pm.

'73 Sonett, 28k mi, yellow, Excellent Condition. \$4500. Ray Koren, 2515 Bristolwood N, Grand Rapids, MI 49504. 616-784-4328.

'73 Sonett, one owner Calif car, 75k mi on rblt eng & trans, Konis, Weber, 96 springs. \$3000 as is, or \$4000 w/fresh Ashcraft-built eng. Steve Gilbert, 2700 Neilson Wy #830, Santa Monica, CA 90405. 213-392-4263

'73 Sonett, body sound, needs some mechanical work. A/C available. MUST SELL NOW! Best Offer. Neil Simon, 2810 S. 162 Plaza, Omaha, NE 68130. 402-330-1604.

'72 Sonett, new seat upholstery, clutch, hoses, water pump, Michelin tires on alloys. End & trans vy gd. Virtually rust free chassis. \$3200 obo. Mike Tucker, 2324 Davis Dr, Matthews, NC 28145. 704-846-4098.

'69 Sonett V4, yellow. Restored, excellent condition. \$5000 obo. Lovell Comstock, P.O. Box 501, Charlestown, NH 03603. 603-826-5985 after 5pm EDT.

93s, 95s & 96s FOR SALE

'72 96, 140k mi, modified dash w/tach, Sonett-type instruments, some rust in pan, needs muffler, restorable or for parts. \$500 obo. Chris Mills, 10 Woods Ln, Chatham, NJ 07928. 201-635-7312.

'72 96, Weber carb, new paint, like new tires, clean interior, plus spare running engine. \$1450 obo. F.V. Gunderson, RD 2, Boonton, NJ 07005. 201-334-7783.

'69 95 V4 Wagon, 150k mi, white, w/'68 nose, straight body, rally exh, AM/FM cass, mechanically exc. 40k on rblt eng & trans. \$895 obo. Colin Diggs, 43 Clusterpine St, Medford, Long Island, NY 11763. 516-654-3630 after 7pm & wknds.

'70 95 Wagon, good running cond, body good shape, many new parts. Best offer. John Trice, 98 Lyons Av, Newark, NJ 07112. 201-926-1736 after 4pm.

'70 96, strong eng, Weber carb, body & interior fair, extra chrome bumpers. \$550 obo. Charles Easter, 1207 Park, Ft Wayne, IN 46807. 219-456-1342, 6-10pm.

'69 96, totally rblt V4 & trans, runs excellent, no rust on body or floor, new brakes, white w/red interior, no dents, looks good. \$750 obo. Chris Connelly, 193 Oak St, Medford, Long Island, NY 11763. 516-654-5430 before 10pm EDT.

'69 95, 125k mi, green, two almost compl. Interiors, needs work. \$500. Ken Hoover, 61 Maple, Crystal Lake, IL 60014. 815-459-8636 (H), 312-381-6850 (W).

'68 95 V4, Exc cond, new paint, roof rack, cruise control, TLC by the Great Kahuna of Saabs, Jack Ashcraft. \$2800 obo. John Hurd, 1219 Eldorado, Klamath Falls, OR 97601. 503-884-1733.

'68 96 Deluxe, whole or for parts. Interior exc except seats. Trans rblt, eng needs work. Body good. Restored in '84. \$750 obo. Bert McNamee, 122 Barrett Ln, Wyckoff, NJ 07481. 201-891-0849.

'67 96 two-stroke, restored by Europa Motors in '85. All original, mechanicals rblt or new. Beige. \$6000 invested. Sell for \$4750 or offer. Ted Marshall, Wilmette, IL. 312-256-8688.

'61 750GT, white, clean interior, new brake lines, '65 Sport axles, factory rblt 850cc eng. \$900 obo. F.V. Gunderson, Boonton, NJ. 201-334-7783.

2-STROKE & V-4 PARTS FOR SALE

Euro lights & grille, easily installed, fits '69 on 95/96, \$300. New '70 Sonett alloy wheels, \$125ea. V4 shop manual thru '73, bound, \$90. Seats in brown, red or blue, \$75ea. Lots of other parts incl 2-stroke. Rob Allen, Hamden, CT. 203-248-8798.

So Neat Stuff for Sonett IIIs: spoilers, louvers, etc. Send SASE to Re-Search, Rt 6 Box 84, Alexandria, MN 56308

Hi-performance V4 parts. Rblt new style trans, new brngs & synchros, 5.43:1 ratio, frwl lockout, \$725. Accel super coil & MSD unit, \$95. Ronal "Mini-lite" style 5-bolt alloy wheels, \$375/set. Oil cooler, remote filter & lines, \$25. "Y" exhaust, \$75. All +shpg. Ron Hunter, P.O. Box 1714, Cave Creek, AZ 85331.

V4 parts, rebuilt alternators or starters, \$65. Rear sway bar for 96 or 97, \$75. Rust free '69 96 body w/suspension. Many used V4 racing parts. Send SASE for list. Mike Tucker, 2324 Davis Dr, Matthews, NC 28105. 704-846-4098.

Fuse box cover for Sonett V4 & III up to Chassis #71501200, \$10. Can't be ordered from Saab. Other parts, too. John Ball, 4251 Yorkshire, Detroit, MI 48224. 313-882-0129.

Sonett fiberglass parts, '68 nose, body & doors, '67 nose. \$250 +shpg takes all. '66 96 grille, trunk & hood, \$100 +shpg. Al Krebs, Holicong, PA. 215-794-7098.

Wood steering wheel, \$25 +shpg. Monte Carlo seat, needs cover, otherwise perfect, \$25 +shpg. F.V. Gunderson, RD 2 Box 344, Boonton, NJ 07005. 201-334-7783.

Engine from '72 Sonett, 60k mi, \$200. Many other 96/95 trans & eng parts. Nicholas Hayden, 3385 W 86, Cleveland, OH 44102. 216-281-9823.

Rear window glass and radiator from '64 96. Bruce Alexander, 4719 Pitt, Duluth, MN 55804.

99s & 900s FOR SALE

'79 900T, black, 3dr. New turbo, valve job, water pump, rblt starter. 205 P6s, good interior. Needs work. \$1995. Ken Hoover, 61 Maple, Crystal Lake, IL 60014. 815-459-8636 (H), 312-381-6850 (W).

'86 900 Turbo SPG, 2800 mi, 5-spd, Clarion component sound system, leather, power roof, air flow kit, suspension package, mint, minor damage repaired by expert. \$15,900. Michael Caro, 278 Boston Post Rd, Orange, CT 06477. 203-795-0776.

'82 900T, 4dr, 5spd, 78k mi, New turbo, shocks, exh, trans & clutch. Intercooler, stereo, much more. Showroom condition, mech exc. \$7500. John Hulbrock, 131 Mill Brook Cir, Norwood, NJ 07648. 201-768-4621.

'77 99GL 5dr, body good, A/C, int. fair, high miles but reliable. \$1500. Tom Parker, 3705 Sharon Rd, Midland, MI 48640. 517-835-8387.

'77 99GLE, needs input shaft & other work, few dings in body but otherwise straight. \$300. Greg Kopriva, 950 Banning, Marshfield, MO 65706. 417-468-6794.

'76 99GL Wagonback, nice body, interior; peppy engine, custom cams/headers; Konis, tach, rear louvers, Sony XR57R AM/FM cass, Thrusters, all records. \$2500. Fred Greene, San Jose, CA. 408-978-5427.

'76 99GL, 2dr, 4spd, 120k mi, good tires, new water pump, front rotors, rblt calipers, cyl hd at 95k, AM/FM cass, halogen hdlts, spare cyl hd. \$1150. Dale Olson, 2421 Mayfair Av, White Bear Lake, MN 55110. 612-429-1799 eves.

99, 900 & 9000 PARTS & ACCESSORIES

4 Inca alloys from '78 99T, \$325. 4 EMS alloys, \$200. Spoiler from '78 99T, \$50. European Cibie quad round headlights, \$50. Tom Parker, 3705 Sharon Rd, Midland, MI 48640. 517-835-8387.

900 thru 16 valve dismantled cars. 16v eng compl w/FI & turbo, wiring, intercooler, brain, etc. Drivetrains for 900 & Turbos, interiors, heads, manifolds, radiators, suspension, power steering, gauges, etc... Michael Caro, 278 Boston Post Rd, Orange, CT 06477. 203-795-0776.

4 New SPG wheels w/caps, \$700. 4 new Pirelli P6 tires, \$375. 4 new '86 900T wheels, \$700. '87 900 Clarion sound sys, used 2 mos, \$800. Michael Caro, 278 Boston Post Rd, Orange, CT 06477. 203-795-0776.

Parting out: '86 900T 16-valve, automatic, complete, nice leather. '86 900 8-valve, 5-spd, 9000 mi. '84 900T, nice blue interior, 54k '81 900 base car, 5-spd. '79 900T, red interior. Dennis Sweeney, 207 E. Church St, Ligonier, PA 15658. 412-238-4556.

Trailer hitch, 900 w/trunk, \$75. 2 good used "S" wheels, \$100 ea. 3 blemished Shelby wheels, \$90 ea. 1 EMS wheel, \$75. 1 New steel, \$25. New 900 3dr wind deflectors, \$50. Km/hr speedo for 9000, \$90. Tach/speedo cluster for '83 turbo, \$125. Rob Allen, 203-248-8798.

New 99 front spoiler w/hdwe, \$65. 99 Sport pin-striping pkg, \$20. Cassette holder for '83-on 900, \$20. '82 900T front spoiler w/hdwe, \$40. Ara Margosian, 5 Ingalls Terr, Swampscott, MA 01907. 617-599-4987 or 617-536-5116.

Steering wheel, 3-spoke from '85 900T, \$80 +shpg. 2 OEM 900 hdlit assemblies w/sealed halogens, \$60 +shpg. David Leong, 3087 Hartman Wy, San Diego, CA 92117. 619-592-4852.

New molded front carpet for 99, \$50. Steven Rossi, Trails End, 37 Pawson Trail, Branford, CT 06405. 203-481-0533 eves & wknds.

Black vinyl bra for 83-86 900, embossed SAAB logo, new in box, \$60. Mike Emmerson, 3475 Woodfront Pl, Indianapolis, IN 46222. 317-925-1283

99 Parts from '74 99L & '78 GLE. 2.0l cyl head, \$110. '74 4spd trans, rear lights, seats, all glass, FI equip, etc. Send SASE for list. James Mackay, Box 464, Wheaton, IL 60189. 312-668-4438.

Continued on Page 17

MEMBERSHIP/SUBSCRIPTION

NAME _____

ADDRESS _____

CITY _____ STATE _____ ZIP CODE _____

PHONE _____

SAABS OWNED _____

(Year & Model)

Please check appropriate box(es):

- FIRST YEAR \$18.00
 RENEWAL \$15.00
 CANADIAN Add \$3.00 U.S.
 INTERNATIONAL ... Add \$7.00 U.S.

Individual back issues (from Jan. '86 on; no June, Aug./Sept. left) are available for \$1.50 each; 3 or more \$1.00 each.

- Collection of 10+ back issues \$10.00
 SAAB Club Decals, \$1.00 each.

SEND TO:

SAAB CLUB OF NORTH AMERICA
2416 London Road, Unit 900
Duluth, Minnesota 55812-2221

1340 HARTFORD AVENUE
JOHNSTON, RI 02919
401-831-8850 in RI

**SPECIAL INTEREST
CARPARTS**

Call Toll Free 800-556-7496
or 800-851-5600 Today!
Monday-Friday 8:30-7:00 EST
Saturday 10:00-4:00 EST
Sunday WE REST!!!

SPECIAL INTEREST SPEAKS SWEDISH!!!

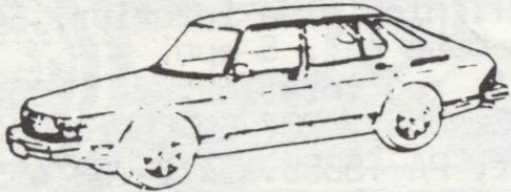

SAAB SPECIALS

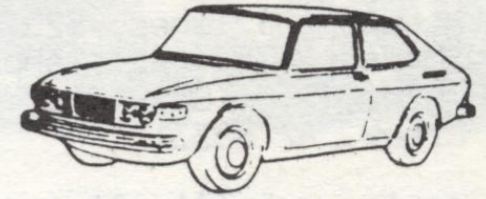

Description	Price
Lambda Sensor 99,900 78-84	\$ 59.95
Air Filter 99,900 75-84	6.95
Ball Joints - upper or lower (all models exc. 9000)	12.95
Ft. Calipers 99,900 75 on	119.95
Tie Rod Ends 95.96	6.95
Tie Rod Ends 99,900 75 on	7.95
3 Piece Clutch Kit 68 on (4-speed)	89.95
Ft. Brake Rotors 99,900 75-80	19.95
Rear Brake Rotors 99,900 70-80	19.95

Description	Price
Brake Master Cylinder 99,900 8-74 on	119.95
Brake Master Cylinder V-4 71-74	49.95
Wiper Blades 900 Turbo 79-85	3.75
Wiper Blades 95.96	3.75
Ft. Brake Pads	8.95
Rear Brake Pads	7.95
Front End Mask (Bra) 99,900 Turbo	64.50
Timing Chain 99 69-72	10.95
Carb. Repair Kit 99 69-73	12.95

If You Do Not See It, Call Us! We Can Usually Find What You Need

Prices are subject to change without notice. Payments available by Visa, MC, AMEX, Diners Club. C.O.D. orders will be an additional \$1.90. Rhode Island residents add 6%. Sales Tax. All Back Orders sent actual shipping. Any item over the UPS limitations will be sent F.O.B. Rhode Island. Prices are good only for the month they are advertised in. Copyright © 1987 by Special Interest Car Parts



2416 London Road, Unit 900
Duluth, Minnesota 55812

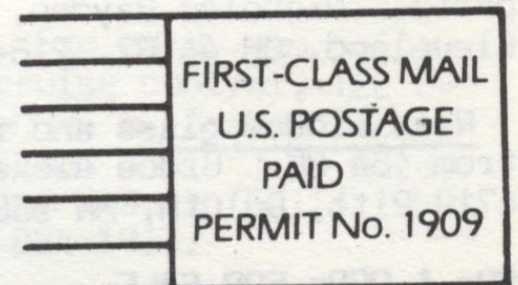

FIRST CLASS

AUG./SEPT. 1987

Exp: 87 12 R