



NINES

THE SAAB CLUB NEWSLETTER

\$1.50

May

1987

no. 159



Retiring chief executive of the Saab Car Division, Sten Wennlo, bridges the gap between the first Saab, a model 92 -- and the two millionth Saab, a 9000 Turbo.

TWO MILLIONTH SAAB BUILT

A white 9000 Turbo, that rolled off the assembly line of the main car factory in Trollhattan in early March, was the Two Millionth car produced by Saab-Scania. The new car was driven to the Saab Car Museum near the factory immediately after it was finished, to become part of the company's permanent display.

The very first series produced Saab came off a line in the same factory in 1949. Twenty six years later, in early 1976, the one millionth car rolled out. The second million was produced a lot faster -- it took only 11 years.

Since its start as a car company, Saab has produced a variety of models, ranging from the original Saab 92 to the current 900 and 9000 series available today. The Saab 92-93 series was built in some 73,000 copies over a 10-year period; while the Saab 95 Station Wagon and Saab 96 Sedan were in production for nearly 20 years, during which time 658,000 were produced. The Saab 99/90 appeared in 1967 and the production was ended early this year, after 613,000 had been built. The Saab 900 line, which appeared in late 1978, has already accounted for 590,000 units.

RESTRUCTURING AT SAAB-SCANIA

Separate automobile and commercial divisions have been established within Saab-Scania of America, Inc., in order to streamline operations in all areas of the corporation's activities, according to President Robert J. Sinclair.

"With our ever increasing involvement in importation and marketing of Scania heavy trucks, as well as the manufacturing of Scania

city transit buses, and the strong growth of our Saab automobile business, the time has arrived for a basic restructuring of our company to position us for continued growth," said Mr. Sinclair.

Heading the new Saab Car Division is Sten O. Helling, who has been appointed Executive Vice President of the company and Deputy Chairman of the corporation's Executive Committee, a new entity with Mr. Sinclair as Chairman.

At the same time, Eugene G. Agres was named Executive Vice President - Administration, responsible for finance and internal support functions. Mr. Agres was previously vice president for finance and administration.

Also appointed vice presidents are:

Kenneth F. Adams, V.P. - Finance. Mr. Adams is also treasurer of the company, a position he has held since 1974.

Peter A. Berla, V.P. - Marketing Services, from national advertising and sales promotion manager.

William F. Murray, V.P. - Parts and Service, from national parts and accessories manager.

John Phelps Clark, V.P. and Corporate Counsel, from secretary and general counsel. Mr. Clark also has interim responsibilities for the direction of the company's new Commercial Vehicles Division, which consists of Scania truck marketing, Scania bus manufacturing and Scania bus marketing.



NINES Editor tries out Saab's new Passive Restraint System. Details on page 4. (Nancy Bergman photo)

FROM THE BACKSIDE

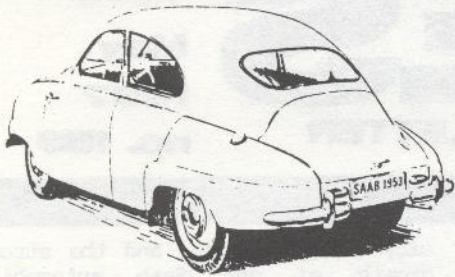

I do a lot of reading each month. I subscribe to about a dozen magazines, primarily of the automotive type, with a few computer magazines tossed in to help keep the office work a little more efficient. There's a pause in the workday whenever the new **AUTOMOBILE, CAR & DRIVER, ROAD & TRACK, SPORTS CAR, AUTOWEEK** or **ON TRACK** arrive.

There are times when a story is "leaked" to one of the major magazines, so we all read about it there first. Then again, they have reporters and stringers who can seek out that stuff. When I can, I publish any news that may have appeared in one of those magazines, giving credit where it is due. Saab-Scania's P.R. folks, Len Lonnegren and Karen Nobile, are very helpful in sending releases, and the Tech Services department sends all the latest Service Informations to keep Saab owners informed (they are no longer publishing Service Tips). I research and write a few stories when I can. But I rely on the membership for the bulk of what gets published each month.

There are always magazines that I don't see, European or auto industry periodicals primarily, that sometimes have stories on Saab. Members often copy or cut out those articles and forward them to me. (One of the more interesting ones lately was from **WARD's Auto World**, which indicated Saab would not join into any more alliances like the one that produced the Saab 9000. All future vehicle projects will be strictly in-house, though subsystems like antilock brakes would still get joint development with the component suppliers.) Some folks send along driving impressions of Saabs from their local newspaper.

Many regional clubs send their publications as well. Some are one short page with meeting notices, others are pretty in depth with lots of tech stuff and good information

that somehow reached their editor, but didn't make it to my mailbox. There are sometimes good tech articles which may get "borrowed" for **NINES** (with proper credit, of course). I'm always looking for more articles of the "How I fixed my Saab" variety, including performance tuning stories.

50th Anniversary

There is no more news on the Saab 50th Anniversary celebration in Trollhattan August 30th. There is another group organizing to make the trip, however. As published a couple of months ago, there will be a flight leaving from New York's Kennedy Airport on August 28th. Andy Federowski has organized a similar group fare out of Chicago's O'Hare Airport on the same date. It is also a two week trip, returning from Stockholm. Round trip air fare is \$789. Call Andy at (312) 902-1200 ext. 2610, for details.

Though I am planning to make the trip to Sweden, my schedule will be a bit different. The 1000 Lakes Rally in Finland is being held beginning August 26th, so I'm hoping to catch the start of that, then travel to Trollhattan for the International Club gathering. I also have to be back in the U.S. for my brother's wedding September 12th.

Tulsa Convention

Several Saab-Scania dignitaries will be on hand for the National Convention as in past years, including rally driver Eric Carlsson. No other late news on this front, as the organizers seem to have things pretty well together already. Send in your registration soon, so the Tulsa Club can get an idea of how many T-shirts to print up and work on other details that have a longer lead time.

Passive Restraints

Saab's version of the Federally mandated passive restraint system is now available on the 900S. Saab chose to try a belt system first as the cost is lower and the development time shorter. Saab engineers do want to gain experience with both the belt system and air bag systems, so air bags will be available on one of the 9000 models in the near future.

Thanks to Dave Becker and Mark Sanders at Steve Lisle VW-Saab in St. Paul for the chance to try out the passive seat belt. As one who always uses his safety belt, the passive system holds little interest. The lap belt still has to be buckled manually, anyway.

Drive carefully, and we'll meet again next month.

NORFOLK, VA area -- contact Alan Tim Winker Bellinoff, (804) 340-7097.

REGIONAL CLUB NEWS

APPALACHIAN SAAB CLUB -- The May meeting will be a picnic at Panther Creek State Park near Morristown, TN. For info: Wendell Francis, Rt. 5, Box 334, Dandridge, TN 37725. (615) 397-2172.

CENTRAL ILLIANA SAAB CLUB -- The British Are Coming! Meet with British Saabers Tony and Meta Percy, May 23rd, 4:30pm, at the Country Mansion in Dwight. Reserve your spot by 5/10. Call Margrit Adler, 1507 W. University Ave, Champaign, IL 61821. (217) 356-9244.

DELAWARE VALLEY SAAB CLUB will take a trip to the Gast Car Museum in Strassburg, PA on Sunday, May 17, 2pm. For info contact Doug Signorovitch, (215) 622-7047

GREAT LAKES SAAB CLUB will meet Sat., May 9th, 1pm, at Keenan Saab in Grand Rapids, MI, for a Technical Seminar. That will be followed by a Swedish Pot Luck at Kathy & Tad Gilliams'. Jim Laman, (616) 335-5215.

NEW ENGLAND SONETT CLUB -- Annual meeting to be held at the Museum of Transportation, Larz Anderson Park, Brookline, MA. It is scheduled for Sunday, June 7th. P.O. Box 4362, Manchester, NH 03108.

TULSA SAAB CLUB -- meets the 4th Tuesday of each month at 7:30pm at Mazzio's Pizza, 5119 S Sheridan, Tulsa. (Note change in meeting location.) Contact Paul Glavas, (918) 250-2150.

TWIN TIER SAAB CLUB -- Meetings held the 1st Saturday, 2pm, at Alex Barbier's house in Waverly, NY. Nick Pellegrino of Foreign Motor Repairs will be at the May 2nd meeting. Call Alex at (607) 565-2711 for directions.

WEST MOUNTAIN SAAB CLUB (New York/New England) -- Spring Rallye 87 on May 25th. We will assemble in northern CT for a straightforward TSD rallye and parade to Lime Rock Park, where we'll watch the Barber Saab Pro Series race. All Saabers in northeastern U.S. encouraged to attend. David Sullivan, 314 Union Av, Framingham, MA 01701-6319. (617) 879-8288 after 6pm; or Mike Blair, (617) 525-3872.

WESTERN PENNSYLVANIA SAAB CLUB -- Spring Picnic will be Saturday, May 16th, at North Park. Prizes, live music, food, Vintage Saab Show. Call Andy Bittenbinder, (412) 364-4780.

Saab Club of North America

Editor & Publisher: Tim Winker, 2416 London Rd., Unit 900, Duluth, MN 55812

(218) 525-3253, 9 a.m. - 8 p.m., except Sunday

ASK BOB

Send your questions to:

ASK BOB
c/o NINES
2416 London Road, Unit 900
Duluth, MN 55812-2221

"ASK BOB" is a regular feature of NINES. Submit your questions with as complete information on the problem as possible, also giving the year and model of SAAB. Problems that are of general interest will be answered here. Questions regarding High-Performance tuning and modifications will not be considered for publication in this column.

Neither Bob, NINES, nor the Saab Club will be responsible for repairs undertaken as a result of information in this column. For a proper diagnosis, it is recommended that you have your car serviced by an authorized Saab dealer.

Can you tell if the Turbo boost gauge calibration corresponds to any particular boost pressure?

J.C., NJ

My experience is that when doing service on a turbo equipped car, I use a good gauge whose dial is calibrated in pounds per square inch. I don't feel there is any spot on the Saab gauge that I could tell you is your maximum boost point. It seems to vary slightly car to car.

I've had my '83 900 aligned every 1000 miles, and my alignment shop is continually removing adjustment shims. At 100,000 miles, I have only one left on each side. Where do I go from here?

T.G., MI

First check ride height as the springs may have sagged. As a last resort, SAAB makes some offset inner suspension pieces that will solve your problem. Remember, there are lots of springs for different years and models.

My '85 900 has had a starting problem from day one. When first started in the morning it goes from 300 to 1000 rpm and back and forth for about 15 seconds. Any fix?

B.R., NJ

Your SAAB dealer has a kit for this one.

The heater knob vibrates on my '85 900 when it's in the heat range.

W.S., PA

There is a SAAB service bulletin on this [possibly S.I. 01/87-915, March 87 NINES]. See your dealer.

How do I reset the EXH light which came on soon after the dealer performed the 30,000 mile service?

H.M., MA

He should have done it as part of the service. However, if you want to do it, remove the bottom of the dash on the driver's side (3 - 10mm bolts) and feel up over the clutch pedal to find a small speedometer cable coming down to a VDO counter. Right beside where the cable attaches is a button. Push it. Fixed. There is also a sheet metal screw that sticks through in the same area. Watch out. Ouch.

The shop manual for my '86 9000 says there is no drain plug for the transmission. Also, how can 10W30 motor oil be considered sufficient in a transmission?

A.O., CA

Again I urge you to go with the guys that built the car. If indeed you want to change the oil, get a suction gun and put a long tube on the end. 10W30 oil is OK because the gears are loaded much lighter in a transverse transmission.

I'm considering changing springs and shocks on my '79 900T because the springs are sagging and the shocks are shot. Can I do this myself? Where can I get the springs and tools?

J.J., NJ

Your letter gives me the impression that you're not too mechanically inclined, and I urge you to have your dealer tackle this one. First, there are many different springs for different years, 5 doors, 4 doors, 3 doors,

turbo, non-turbo, etc. Second, he has the tools to do it. I doubt any tool but a SAAB tool would do this job, and that means you'd have to buy one from your dealer for a one-shot repair. There is also considerable chance of injury; there is a lot of power in the springs and old gas shocks. Remember, a shock absorber is merely a dampening device. It WILL NOT correct for weak or sagged springs.

I know it would appear that many fixes I give say "Take it to the dealer". Well, don't get the impression that is my standard answer, it most definitely is not. BUT there are certain fixes and adjustments that I simply feel are beyond the capability of the "ASK BOB" letters. When I feel that you (or any SAAB owner) can fix it, I'll tell you how. But if I think it needs special training, tools, and parts, I'll suggest that you take your SAAB "home".

BOB

CLUB SPECIAL - 1/3 OFF!

For a limited time only
The popular Mixer® and Antiturbo®
wind deflectors can be Yours at
incredible savings!



The Mixer®
Originally \$75.00
Now Only

\$49⁹⁵
per pair

Available for:
Saab 900 - 4 door

For more information and to
order, Call: 1-201-751-0444

Or send check or money order to:

 **Cosbar International, Ltd.**
P.O. Box 775
Livingston, NJ 07039

Please include \$5.00 for shipping and
handling

C.O.D. orders are available

The Antiturbo®
Originally \$90.00
Now Only

\$59⁹⁵
per pair



Antiturbo®



SERVICE SUBJECTS FROM SAAB

	Recall	FUEL PRESSURE HOSE
	269	Safety-related NHTSA No. 87V-013 Some M86-87 900S & 900 Turbos

RECALL 269, 900 FUEL HOSE

S.I. 03/87-944, R-3 (\$1.50)

Saab-Scania has notified the NHTSA that a defect which may be safety related exists with late 1986 and early 1987 900S and 900 Turbo models.

The defect is that the rubber fuel hose between the pressure regulator and injector fuel rail may rupture due to stress resulting in a fuel leak, and possibly, a fire.

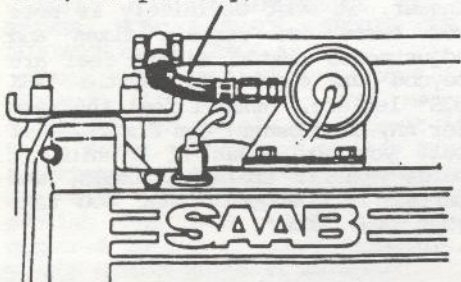

These vehicles are being recalled by Saab-Scania of America to install a new design of this hose:

1986 900S, 900 Turbo
G2025755-
G3019628-
G7029285-

1987 900S, 900 Turbo
H2000001-H2012867
H3000001-H3010345
H7000001-H7018747

Owner notification letters were sent out in late March. If you are the owner of one of these vehicles and have not received a notification letter, please contact your nearest Saab dealer to arrange for repairs.

CORRECT THERMOSTAT APPLICATION

Application: 16 valve engines
900 - S.I. 03/87-943, A-2/p.201
9000 - S.I. 03/87-945, B-2/p.7

Because of the similar appearance of the 8V and 16V thermostat, it is possible to install the incorrect thermostat in the 16V engine. The result could be a temporary loss of heater output when the thermostat is fully opened.

The 16V thermostat 88-17-538, can be identified by its locating tabs which insure its proper alignment in the cylinder head. Additionally the lower disc is perforated to allow for coolant circulation to the heater when the thermostat is fully opened.

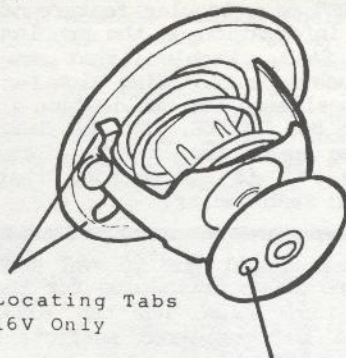

Locating Tabs
16V Only

Bleed Hole-16V Only

Use only genuine Saab three stage thermostats. Aftermarket units do not always have the same opening characteristics nor do they have the same flow design. Improper thermostat usage could cause any or all of the following: Overheating and possible engine damage, low or no cabin heat, sludging of the engine.

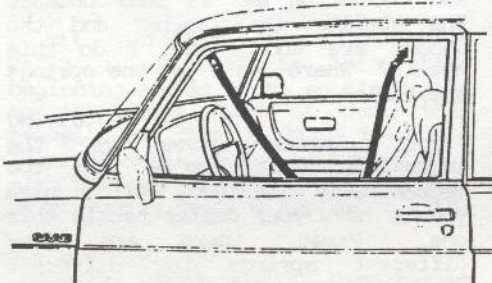

PASSIVE SEAT BELT SYSTEM

Application: 87-1/2 900S 3dr
S.I. 03/97-946, A-8/p.103 (\$1.00)

From approximately March 1987 wholesale deliveries, the 900S model will be equipped with a motorized passive seat belt system. This introduction takes place to ensure compliance with the 10% passive restraint phase-in requirements set forth by the Department of Transportation.

This S.I. gives some basic information regarding the new system. The vehicle Owner's Manual also has passive seat belt system information for the operator.

VIN Information

The Federally required 17 character VIN incorporates a new designator to identify the 900S with a passive belt system. Position number 5 will show the letter "K" (instead of a letter "S").

YS3 A K 3 6 D X H2000001

K = S model with Passive Belt

Radio Information

The radio/cassette unit is the same as before. The lower dash or kick panel has been enlarged to provide improved anti-submarining restraint. A redesigned center console and modified radio amplifier mounting reflect this change. The amplifier has been moved outward

slightly and the tidy box has been replaced with a grille. The Turbo equalizer cannot be installed. The amplifier may still be removed with the radio removal tools.

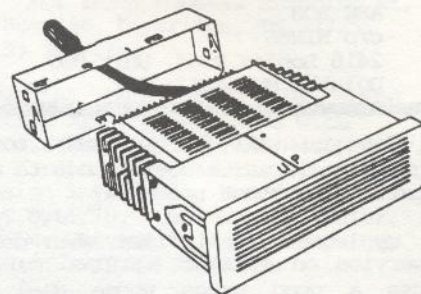

Modified Radio Amplifier

System Maintenance

The system requires no maintenance other than an occasional lubrication of the belt rails. Saab recommends that this be done at intervals of 30,000 miles (or every 15,000 miles if the belts are activated more often than normal). The only lubricant that may be used is Saab P/N 02-01-285 (Gleitmo 300). Other types may run out of the rail and contaminate other parts of the system.

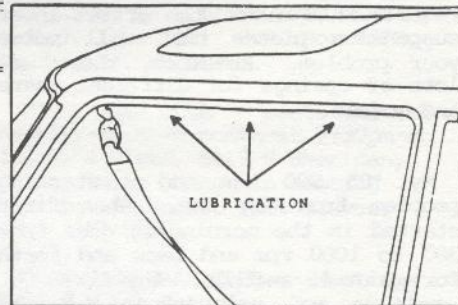

LUBRICATION

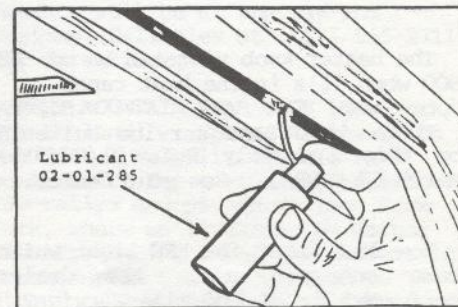

Lubricant
02-01-285

Operating Sequence (Driver's side)

Parked: The driver's shoulder belt is always stored at the A-pillar.

Entering: When the driver sits down, the belt will remain at the A-pillar until the door is closed and the ignition is turned on. At this point the following will occur:

- The belt will travel to its locked position on the B-pillar.
- An indicator light located in the instrument cluster will flash while the belt is in motion.

The traditional light warning light and buzzer will be on for a maximum

SERVICE SUBJECTS continued

of eight seconds. The buzzer will cancel automatically after eight seconds or as soon as the driver fastens his lap belt.

The lap belt should always be used in conjunction with the automatic shoulder belt.

Exiting: When the driver's door is opened or the ignition is turned off, the belt will return to its parked position at the A-pillar.

Backing up: As a convenience, there is an override function which will keep the belt at the B-pillar when the door is opened as long as the car is in reverse gear.

Operating Sequence (Passenger side)

Entering: When entering the car, the passenger may find the belt stored at either the A or B-pillar. If the belt is at the B-pillar it will automatically move forward as soon as the door is opened. After closing the door, the belt will stay at the A-pillar until the key is turned on - the belt will then move to the B-pillar. This will occur even if the passenger's seat is unoccupied in order to provide the driver with an unobstructed view out the side window. If the passenger enters a running car, the belt will move back as soon as the door is closed. Fastening the passenger's lap belt has no effect on the warning light and buzzer operation.

Exiting, key off: When the ignition is turned off, the passenger's belt will stay at the B-pillar until the door is opened. As soon as the door opens, the belt will move forward and stay at the A-pillar until the ignition is turned on again.

Exiting, key on: If the passenger exits the car while it is running, the belt will move forward when the door is opened and back again when the door is closed.

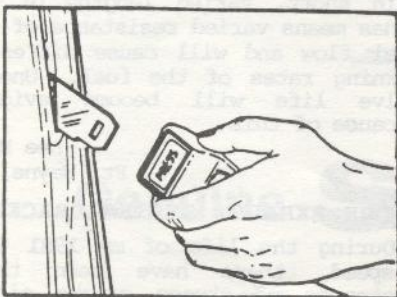

Manual Overrides

The shoulder belts have a release buckle at their upper end. The belts can be quickly unfastened in the event of a system failure. If the belt transport mechanism should fail, the belts may still be worn by using the two locking clips located in the tool kit. These adapters are different (mirror images of one another) for the left and right sides. They lock in place at the

B-pillar and are held in place by a small latch which must be pushed to one side to remove the clips.

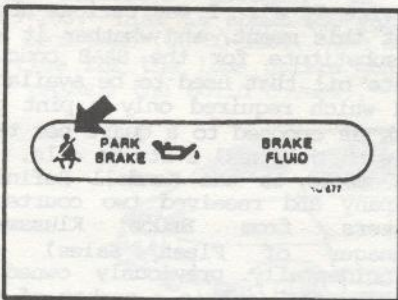
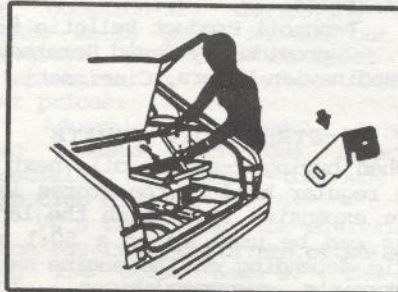
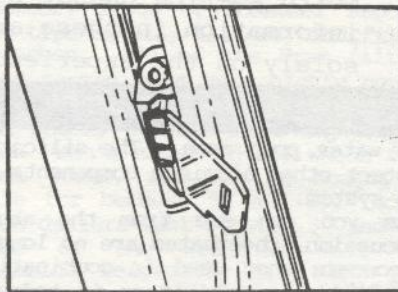

Dash Warning Light Function

The instrument cluster light will flash slowly under the following conditions:

- When the driver's belt is moving from the A-pillar to the B-pillar.
- If the belt does not lock at the B-pillar or the microswitch does not sense that it has.
- The belt is locked at the B-pillar, but there is a failure in the override system for the acceleration and tipping sensors in the belt retractors.

The light will glow continually when the shoulder belt is unbuckled and allowed to retract into its reel on either side. In the event of two simultaneous failures, a flashing light will take priority over a steady one.

IGNITION SYSTEM AMPLIFIER, PROPER HANDLING PROCEDURE

Application: All 900 and 9000
900 - S.I. 03/87-955, A-3/p.104
9000 - S.I. 03/87-956, B-3/p.7

If the ignition amplifier (power stage) is removed or disturbed for any reason, high dielectric silicone grease must be applied between the amplifier and the heat sink. This

Saab Service Tips & Service Information are provided to the Saab Club as a courtesy to Saab owners by Daniel L. David, Manager of Technical Services, and Robert J. Sinclair, President of Saab-Scania of America, Inc.

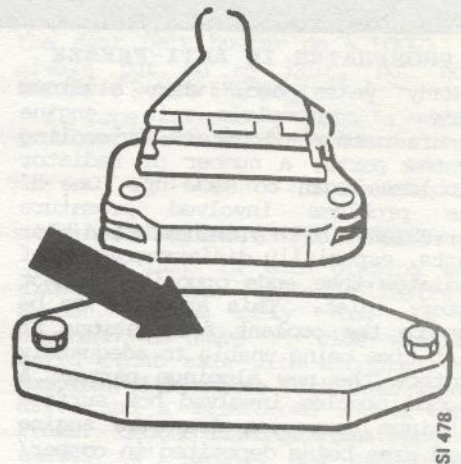

grease is necessary to ensure proper heat transfer from the amplifier to the heat sink.

High dielectric silicone grease is available at auto supply stores (Example: Permatex Dielectric Tune-Up Grease, Part No. 67VR).

ROADSPORT
MOTORING ACCESSORIES

900 SHIFT KNOB
Leather: black, brown, tan, red, blue, & gray **32.50**

ALISON ELECTRONIC IGNITION SYSTEM **64.00**
3 cyl. w/points 63-68
4 cyl. w/points 68-81

ROADSPORT
8351 Roswell Road
Suite 140
Dunwoody, GA 30338
(GA RESIDENTS ADD 5%)

CALL THIS NUMBER
Y 215-752-3000

FOR:
 - OEM SAAB PARTS
 - CLUB DISCOUNTS
 - FAST UPS SERVICE

Bob Yates
IMPORT CAR SPECIALISTS
Rt. 1 & I-95 Langhorne, PA

S A A B

TECHNICAL TALK

Technical articles written by subscribers may recommend procedures or parts not approved by Saab-Scania of America, Inc. The Saab Club of North America cannot stand behind the correctness of information in these articles, but offers them based solely on the experiences of the writers.

PHOSPHATES IN ANTI-FREEZE

Many years ago, when aluminum became commonplace in engine manufacturing and for use in cooling system parts, a number of radiator problems began to show up. One of the problems involved premature corrosion of aluminum radiator parts, especially disintegration of radiator tube ends opposite the hot water inlet. This appeared to be due to the coolant formulations at that time being unable to adequately protect the new aluminum parts. A second problem involved hot surface aluminum corrosion from the engine head area being deposited in copper/brass radiators, leading to overheating. The deposited material was found to be high in aluminum and phosphorus, and was therefore assumed to be due to a combination of aluminum corrosion and deposit from phosphate antifreeze additives. In either of the cases above, it became apparent that a new generation of coolant additives was needed.

Detailed studies have shown that aluminum corrosion is affected by coolant pH, temperature, temperature changes, and the type of inhibitor additives in the coolant. Phosphate and silicate inhibitors were also shown to have varying levels of effectiveness depending on whether the aluminum was on a hot or a heat-rejecting surface. Silicate inhibitors were found to protect well against corrosion, especially on hot surface aluminum. Phosphate inhibitors were found to offer corrosion protection primarily to aluminum on heat-rejecting surfaces. In the absence of silicate inhibitors, the phosphate inhibitors were actually observed to accelerate hot surface aluminum corrosion. This was the reason for the concern over phosphates in antifreeze. This was a valid concern in the absence of silicate inhibitor, however, when phosphates are used in conjunction with silicates, corrosion is no longer a problem.

Pennzoil Anti-Freeze is formulated to be compatible with all metal components, including today's modern systems with high aluminum content. Silicate inhibitors are used as the key ingredient for protection of all aluminum parts. Small amounts of phosphates are added to protect aluminum water pumps used in most engines. The water pump area sees more turbulence than other aluminum parts, and the silicates can be washed away. The phosphates form a stronger bond and protect well in

the water pump area. The silicates protect other aluminum components in the system.

As you can see from the above discussion, phosphates are no longer a concern when used in combination with silicate inhibitors in today's modern antifreezes, such as Pennzoil Anti-Freeze.

Pennzoil Product Bulletin #346 provided by David Horstmeyer Scandinavian Motors, Cincinnati, OH

2-STROKE OIL UPDATE

When buying 2-stroke oil, next to the regular kind in the stores is a more expensive type which the label says can be used up to a 50:1 mix ratio depending on the engine manufacturer's recommendations. This oil is labeled "B.I.A. Certified for Service TC-W". I was curious about what this meant, and whether it was a substitute for the SAAB concentrate oil that used to be available and which required only a pint per tank as opposed to a quart per tank as with the usual 2-stroke oils.

I wrote to the Kendall Refining Company and received two courteous letters from Bruce Klusmann (Manager of Fleet Sales) who coincidentally previously owned a 2-cycle SAAB and is a member of the SAAB Club. His first letter stated, "B.I.A. TC-W stands for Boating Institute of America, two-cycle water-cooled. In order to be so certified, the oil must pass the most stringent testing requirements currently used in the oil industry. Benefits of a BIA certified oil compared to normal 2-cycle oils include superior resistance to corrosion during a storage period and reduced deposits in the combustion chamber and exhaust port area."

In March '87 I received a second letter which said, "We have finally been able to obtain a sample of SAAB HI-M oil concentrate for examination. After extensive analysis it was determined that this product contained a solvent to aid in mixing, approximately 50% bright stock, and a calcium sulfonate which was most likely added to prevent deposit formation from the bright stock. Bright stock is the heaviest oil used in 2-cycle formulation and is considered to be that portion which contributes most to lubrication and load carrying ability. I suspect the large amount of bright stock used was to counteract the effect of only using one pint of oil to 6 or 8 gallons of fuel. Current BIA formulations use approximately

one-half as much bright stock and have superior additive systems for preventing deposits and controlling corrosion during engine storage periods. For this reason I would suggest using a BIA oil, but at a mixture ratio of approximately 32:1 (8 gallons of gas to 1 quart of oil). It is likely the engine would operate with no problems at a ratio of 50:1 but I feel it is best to err on the conservative side."

Douglas Rugh
Sevierville, TN

ON FUEL LINE LENGTH

I'll have to throw out an opposing viewpoint to David Stanley's comment that the length of fuel injector lines on continuous systems are unimportant. (March 87 NINES).

Even on continuous fuel injection, it is important that injector lines are of matched lengths and matched inside diameters. Shorter lines will offer less fuel flow resistance and the combustion chamber's fuel-to-air-flow ratio will be richer. The longer lines will offer more resistance to fuel flow, hence the mixture will run leaner.

The average pressure, expressed as the Brake Mean Effective Pressure (BMEP), in each cylinder must remain equal. Less fuel molecules (lean mixture) means lower combustion pressure and will possibly show up as an erratically rough running engine. Combustion chambers experiencing the leaner mix will have a shortened valve life. Leaner mixture will burn hotter, eventually warping or burning the valves.

In short, varied lengths of the lines means varied resistance of the fuel flow and will cause different burning rates of the fuel. Uneven valve life will become evident because of this.

Lee Beck
Ft. Wayne, IN

MORE EXHAUST SYSTEM CRACKS

During the life of my 1981 900S 5-speed, there have been three instances of stress cracks either immediately before or after the catalytic converter. In each case we were able to have the cracks MIG welded. The problem appeared to be a lack of support for the converter which is suspended by the exhaust manifold and the muffler hanger. GM cars in comparison have a support at the converter. It was simple to add a bracket, using rubber to prevent floorpan vibration.

Dennis DeLeonard
Germantown, TN

ANOTHER 9000 FANATIC

I have just read Herb Hirsch's letter in the April issue. I, too, have a 9000 with 18,000 miles on it and share his favorable observations: the car is a delight and a vast improvement over my 1981 900 Turbo, especially in terms of mechanical reliability.

I can shed some light on a couple of his questions and offer some minor 9000 tips of my own.

1. My central locking recently failed (see below), and fortunately the access to the fuel filler door lock described in the Oct. '86 NINES was available on my car, despite its lower VIN than the one cited in the Service Tips. Owners might check this out before an emergency arises. If there are 9000s without this access, it should be possible to remove the trunk lining without damage to get at the lock.

2. Getting around reverse gear "block out" is often easier than the way mentioned in the March '86 Service Tips: keeping the clutch depressed, shift into first, then into reverse.

3. My central locking failed when fuse 16 (10 amp) blew. A replacement 10A also blew. Although I have not yet seen this in Service Tips, Service Manager and Saab Wizard Armano Giovacchini at B & B Saab in Santa Clara told me that a bulletin has been issued saying that slightly increased current draw is normal with wear. A replacement 15A fuse has been fine.

4. I badly rounded two oil drain plugs before I discovered this: my 9000 has a 1/2 inch hex head, not the 13mm that I had assumed, having nothing but metric tools on my 900.

One-half inch is 12.70mm, and the extra .30mm is enough to do in the plug, even with a good box wrench.

5. Regarding oil changes, all readers should check out the February issue of **Consumer Reports** for tips on oil, filters, and filter wrenches. All of the Fram filters they tested were very highly rated. Although they didn't test the Saab OEM model, it can't be any better than Fram's model PH-16, which fits most Saabs, and can be bought on sale for between \$2 and \$3. Local Saab dealers want between \$7 and \$8. Some of the wrenches that the magazine recommends are also good for the hard-to-get-at 9000 filter.

6. For 900 and 9000 drivers who are occasionally destroying fog lights while going in and out of driveways, there are at least two alternatives to outrageous dealer list prices:

* Advertisers in NINES. I have been pleased with Tosa Imports, especially with their discount to Saab Club members.

* VW's list prices for equivalent Bosch fog light parts are often more than 15% below Saab's. The VW equivalent for the 9000 (and 900?) lens reflector assembly is VW #123-266. List is about \$30 versus \$36 from Saab (02-80-560). The same is true for the lens grille guards (to replace the solid covers). VW#

for the pair is 123-272 (same as Saab P/N 02-80-628).

The complete lamp with housing and mounting, however, appears to be unique to the 9000.

7. Extra window decals warning of the uselessness of ripping off the new anti-theft radios are available from Saab as P/N 02-79-190.

Finally, a question: What's the easiest way to "temporarily disable" the seat belt buzzer on a 9000? I always put on my belt, but not before I start the engine.

I hope everybody else's 9000 problems are as minor as mine.

Bruce Seaman
El Granada, CA

96 LIMOUSINE INFO SOUGHT

The 96 Limo in this drawing was allegedly seen in Trollhatten, Sweden, in the early '70s. It is supposed to have 7" wide wheels, solid front axle with kingpins, an American V-8 engine with rear wheel drive and a reinforced ladder-type frame. Ground clearance was approximately 8"; brakes and suspension details are unknown. Current whereabouts of this car are also unknown. Send any information to:

Rich Roberts
Rowland Motors
517 E. Pike St.
Seattle, WA 98122

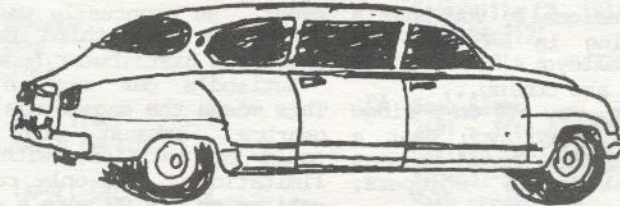

SAAB
PARTS

Genuine **SAAB** Parts
at
Discount Prices

JACK SAFRO

TOSA IMPORTS

6102 WEST NORTH AVENUE • MILWAUKEE, WI 53213

1-800-242-2003 1-800-225-2528

Exclusive **SAAB** Parts Center

The area's most extensive
inventory at
competitive discounts.

(215) 886-8660

Free delivery or UPS

SAAB 

 **VICTOR**

Exclusively SAAB since 1958
1125-35 Easton Road • Abington, PA



Saab's reputation for reliability was established by winning rallies like the RAC and Monte Carlo in the 96.

OLYMPUS ODYSSEY

It's early Friday morning, December 5th, 1986. You are standing quietly with 200 other people lining both sides of a curving dirt road in a southwestern Washington forest. Fog clings to the hilly treed slopes and the air is very damp. The people around you include rallyists, camera crews and photojournalists from around the world and a handful of curious local residents. Occasionally you hear a helicopter flying in and out the deep far off valleys. This is the first sign they are coming...

A moment later, way off on a ridge perhaps a mile away, you hear a "wailing" sound. The crowd becomes very quiet. Someone whispers, "They're coming..."

The wailing becomes more intense, punctuated with explosive rapp-rapp-rapps. Suddenly, a quarter mile down the valley someone screams "Car!" Crowd control whistles shriek loudly up and down the forest road. Everyone backs up five yards, even the experienced European photographers.

Then just out of sight you hear it. The road is literally being torn apart, screaming, wailing, thrashing, upshifts, downshifts, gravel catapulting through trees and bushes -- and then you see it. It roars by like a starship approaching light speed. It was Juha Kannunen in a Peugeot 205-TT16 4WD Turbo. You didn't even have time to take a picture. Your camera hangs limply around your neck. You can't believe it. No car can go that fast on a dirt road. But it did, and in the next 12 minutes, six more Group-B supercars roar by. You are totally stunned, but you were lucky. You had the opportunity to see the B's.

For 1987 they have been banned. Too fast. Right. With four-wheel-drive, 450+ horsepower and 2000 pounds overall weight, these vehicles are closer to fighter aircraft than automobiles.

But this story is also about

Saabs. Three Saabs from the north-western part of the U.S. entered the internationally sanctioned Olympus Rallye. This rallye is in the same league as the famous Monte Carlo, East African Safari and 1000 Lakes. Two of the Saabs were from the Seattle area.

An exceptionally fine drive by Goran Ostland in a '78 99 had him placed as high as 17th overall late on the second day of this four day event. He eventually was forced to retire on the third day with a collapsed distributor bushing.

Ostland's car ran in Group A. This means the engine was stock, but gearbox, exhaust and suspension could be modified, within certain limitations. The only real modifications on his 99 were a close-ratio gearbox, stiff springs, Bilstein shocks and days of careful preparation. Even with these limited changes, Ostland's "old" Saab blew the doors off many newer cars.

And then there was the 96. What a time the Swedish photogs and reporters had! They couldn't believe a Saab 96 was actually going to compete in the Olympus. Apparently it had been years since a 96 had appeared in a European rallye of this importance. And due to FIA rules, the Olympus was the last World Rally Championship event the 96 model was eligible to run. The rules allow a car model to run WRC rallies six years after it has ceased production, and the last 96 was built in 1980.

The 1972 Saab 96 of John Vanlandingham completed three of the four days. The car ran strongly in Group A, running as high as 24th overall at one time. He was finally forced out with gearbox problems when the ring and pinion broke.

To make his car legal for Group A, Vanlandingham had to bring his car up to 1980 specs. This included 1980 style park lights, taillights, and bumpers. The car is repaired now and Vanlandingham cruises the

streets of Seattle, with the 96 still in full rallye trim. It's quite a sight!

All of this brings up an interesting question: Will Saab return to International Rallying? Today Saab is moving toward higher (meaning price) automobiles, and currently sell their entire annual production. I believe they feel they don't need stock bodied race cars to sell their street Saabs, and for now this is true.

Saab-Scania of America sponsors the SAAB-Barber race series. As most of you realize, these open wheeled race cars use standard Saab engines. How much of these Saab-powered race cars do the spectators equate with the Saabs they see on the street? Countless numbers of automobile companies currently compete on race courses worldwide. Some of these are Audi, Ford, Fiat, Lancia, Peugeot, Porsche, Toyota, General Motors and GM of Europe, Nissan, Rover, Ferrari, and Mazda. These companies race because it helps improve their product as well as sell it. Did you recognize any of these names? Of course you did. Saab 9000s and Turbo 900s could be competitive in Group A rallying, and wouldn't it be great to see them back in competition with recognizable stock bodies?

For now it will be up to enthusiasts like Ostland and Vanlandingham to uphold the racing heritage of Saab. I wish them and their counterparts elsewhere in the U.S. and Europe the best of luck!

Rich Roberts
Bothell, WA

96 TAKES LA LOOP PRIZE

Lester Ewing's 1968 Saab 96 took the prize for the highest finishing Saab in the 1987 running of LA LOOP, a 24-hour rallye around Louisiana. Despite some brake problems, Ewing placed fourth in the open class. Initially his co-driver expressed some uncertainty as to whether or not she wanted to spend 24 hours in the PRO-Rally prepared 96, but the final placing put the team in good spirits by the end.

"ESCAPE TO WISCONSIN"

OFFERS SAAB PRIZE

Competitors driving Saabs will compete for a Marque award at the "Escape to Wisconsin" National Road Rally on June 13th. The rally, put on by the Land O' Lakes Region of SOCA, will be run out of Menomonie, WI. Last year's ETW was the SOCA Outstanding National Rally of 1986.

There will also be a Divisional Road Rally, "The Horse You Road In On", Friday June 12th. As an added incentive, the entry fee for those who ran no more than one National Rally last year will be half-price. Details on entry (or working) are available from Dave or Rachel Fuss, (612) 424-4219.



MECHANICS LIST

Once again, a list of independent repair shops, body shops, special services, and Saab dealers drawn from member recommendations and the membership list. It is not to be considered an endorsement by NINES or the Saab Club, and is meant only as a reference guide for members.

Saab-Scania of America also publishes a booklet listing all authorized Saab dealers, which is updated regularly. It is available through your local dealer or from Saab-Scania in Connecticut.

This list is by no means complete. If you have an addition or correction, please send it to the Saab Club at the address below.

MECHANICS LIST

c/o The Saab Club
2416 London Road, Unit 900
Duluth, MN 55812-2221

- | | | |
|--|--|--|
| <p>AK Lee Johnson
P.O. Box 2777
Kenai AK 99611</p> | <p>CA Masada Motors
9027 Sepulveda Blvd.
Sepulveda CA 91343</p> | <p>CA European Autoteile, Inc.
Byron Won
1311 - 67th Street
Emeryville CA 94608
415-654-9121
Saab parts & accessories</p> |
| <p>BC Viking Automotive Ltd.
Jann Thulin
115 Charles St
North Vancouver BC V7H 1S1
929-1410
Ind. Saab, Volvo, M-B repair</p> | <p>CA J & B Imports
Bud Clarke
1547 Struck
Unit L
Orange CA 92667
Saab & Volvo repair</p> | <p>CA Saab Saver
2601 - 35th Ave.
Oakland CA 94619
415-532-SAAB (-7222)
Saab repair</p> |
| <p>BC Swedish Auto Sport Inc.
Bob Young
8930 Shaughnessy Street
Vancouver BC V6P 3Y5
321-1049
Ind. Saab Repair</p> | <p>CA Sven's Import Car Service
Sven Aberg
653 Avenue of Flags
Buellton CA 93427
805-688-1027
Ind. Saab Repair</p> | <p>CA Eurotechs
Bill Makel, Service
Parts Mgr: Jack Deal, Sales
Mechanics: Bill, Nick, Jason, Charles
211 Cedar St.
Santa Cruz CA 95060
408-427-3599
Ind. Saab service & sales</p> |
| <p>CA Swedish Service
Anders Karlsson
11671 Gateway Blvd.
Los Angeles CA 90064
Ind. Saab & Volvo repair</p> | <p>CA Parker Automotive
250-B San Antonio Ave.
Mountain View CA 94040
415-941-0342</p> | <p>CA Import Auto Recycling
980 - 17th Ave., C-7
Santa Cruz CA 95062
408-462-3458</p> |
| <p>CA Swedish Advanced Auto Bay
Lewis Norris
15616 Inglewood Ave.
(1/2 block S. of I-405)
Lawndale CA 90260
213-536-0161
Ind. Saab Repair & Parts</p> | <p>CA Saabcraft
Ted Bunding
912-C West Evelyn
Sunnyvale CA 94086
408-730-0109
Ind. Saab Repair</p> | <p>CA T & S Motors
1394 - 4th St.
San Jose CA 95112
408-297-4665
Ind. Saab repair</p> |
| <p>CA Vasek Polak Saab
Parts Mgr: David Schoenoff
356 So. Sepulveda
Manhattan Beach CA 90266
213-376-0935, -372-5202
800-662-6143 U.S. toll-free
Saab dealer</p> | <p>CA Embarcadero Automotive
210 Brannan St.
San Francisco CA 94107
415-546-1384
Ind. Saab repair</p> | <p>CA Saab Factory
Paul Perry
1245 Campbell Ave.
San Jose CA 95126
408-241-7222 (-SAAB)
Ind. Saab Repair</p> |
| <p>CA Greg's Auto Body
Greg Ganter
9347 Santa Fe Springs Rd.
Santa Fe Springs CA 90670
213-946-5400
Body Shop, Saab & Volvo spec.</p> | <p>CA Perry-Key Body Shop
28953 Mission Blvd.
Hayward CA 94540
415-537-1175</p> | <p>CA Eldon Penner
501 Barhan Ave.
Santa Rosa CA 95404
707-525-1635
Ind. Saab repair</p> |
| | <p>CA Swedish Auto Salvage Yard
1051 - 26th St.
Oakland CA 94607</p> | |

- CO The Saab Shop
Mark Cline
3701 South Santa Fe Dr.
Englewood CO 80110
303-762-0672
Saab repair ('80 & up)
- CO Mile High Body Shop Inc.
Jerry Danner
519 Lipan
Denver CO 80204-4906
303-595-4646
New & used parts, used cars,
repair service, body shop
- CO Saab Center
Jim Addison
5310 E. Pacific Place
Denver CO 80222
303-691-9404
Ind. Saab service & parts
- CO Green Mountain Motors
Tom Ellis
4419 Broadway
Boulder CO 80302
303-449-7380
Saab & BMW repair
- CO Independent Saab & Subaru Ser.
4635 'E' Park Vista
Colorado Springs CO 80918
Ind. Saab repair
- CO Durango Small Car
Steve Rogers
138 Bodo Drive
P.O. Box 2412
Durango CO 81301
303-259-3460
Ind. Saab repair
- CO Bighorn Motors
Dick Zeder
152 W. 6th St.
Glenwood Springs CO 81601
303-945-6544
Saab Dealer
- CT Shoreline Auto Service
Burt Tucker
80 No. Main St.
Route 1
Branford CT 06405
- CT Sir Don of Scania
Don Everson
381 Copse Road
Madison CT 06443
203-245-1757
'Damsels Saved, Dragons Slain,
Saabs Serviced'
- CT Eriksson Industries
Nat Wentworth
42 River St.
Old Saybrook CT 06475
203-388-4418
Saab Machine Shop
Rblt engines, trans, heads
- DE Sports Car Service, Inc.
Bill Jacobson
3500 Governor Printz Blvd.
Wilmington DE 19899
302-764-SAAB (-7222)
Ind. Saab Repair
- FL Saab Services Inc.
John Schreiber
825 N.E. 11 St.
Ft. Lauderdale FL 33333
763-1496
Ind. Saab Repair
- GA Accord Performance
Brian McCall
1771 Jody Dr
Marietta GA 30066
- GA S&J Automotive
Jack Baxter
1491 Howell Mill Road
Atlanta GA 30318
404-351-SAAB (-7222)
Ind. Saab repair
- IA Ron's Auto Repair
119 S. Washington
Ames IA 50010
515-232-8555
- IA British Motors Ltd.
517 Scott Ave.
Des Moines IA 50309
515-244-8791
Ind. Saab repair
- IA Meyer Garage
Main Street
Meyer IA 50455
515-737-2239
Saab dealer
- IA Friedley Saab
Mechanics: Dennis Rosauer
4227 University Ave.
Cedar Falls IA 50613
319-277-1140
Saab dealer
- IL Frew Enterprises
Latch Frew
727 First Avenue
Des Plaines IL 60016
312-299-7153
Ind. Saab repair
- IL Fields Saab
3 Waukegan Road
Glenview IL 60025
312-998-9110
Saab dealer
- IL Swedish Import Auto Works
2772 Skokie Valley Rd.
Highland Park IL 60035
312-432-8510
Ind. Saab & Volvo repair
- IL Europa Motors
2414 W. Route 120
McHenry IL 60050
815-385-0700
Saab & Subaru dealer
Parts, service & body shop
- IL Petersen Automotive
Jon Petersen, Owner
Mechanics: John, Drew, Mike
7626 Parkside Ave.
Skokie IL 60077
312-675-6540
Ind. Saab & Volvo repair
- IL Flikkema Motors
2424 E. 176th St.
Lansing IL 60438
312-474-1933
Saab dealer
- IL Wigglesworth Imports
705 E. Roosevelt
Chicago IL 60605
312-293-1970
Saab dealer
- IL Service Above And Beyond
Fred Cappeler
1512 N. Throop St.
Chicago IL 60622
312-489-7222 (-SAAB)
Ind. Saab mechanic
- IN Gibson Motors
Frank Gibson
Main & Jackson Streets
P.O. Box 186
Perrysville IN 47974
317-793-3512
Saab dealer
- LA Swedish Automotive Service
37376 Manchac Park Dr.
Prairieville LA 70769
- MA Mecca Motors
30 Penniman Rd.
Allston MA 02134
617-787-1707
- MA Charles River Saab
20-32 Watertown Street
Watertown MA 02172
617-923-9230
Saab dealer
- MA Quantum Mechanics
45 Huntington Ave.
S. Yarmouth MA 02664
617-394-5193
Ind. Saab repair
- MD Danneman's Auto Service
100 Lafayette Avenue
Laurel MD 20707
Ind. Saab repair
- MD Scandinavian Import Service
Alan Tetervin
7404-A Westmore Rd.
Rockville MD 20850
301-340-SAAB (-7222)
Ind. Saab repair
- MD Scandinavian Motor Works Inc.
Paul Keith
84 Main Street
Reisterstown MD 21136
301-833-9393
Ind. Saab & Volvo repair
- MD Rosemont Motors
Eddie Gunneau
Frederick MD 21701
- MD Brewer's Saab, Inc.
Kevin Brewer
Main Street
Maugansville MD 21767
301-739-0420
Saab dealer

- ME Porsche Plus
Ralph & Paul Small
2 Heath Street
Old Orchard Beach ME 04064
207-883-2656
207-934-7090
Ind. Saab, Volvo, BMW, M-B
- ME Auto Motion
Willy Lewis
333 Route 1
Falmouth ME 04105
207-781-3903
Ind. Saab Repair
- ME Darryll Fotter
Fairfield St.
Oakland ME 04963
207-465-3272
- MI K & N Automotive
Mechanics: Kirk, Nick, or Don
1240 Jewett
Ann Arbor MI 48104
313-665-9944
Ind. Saab Repair
- MN Morrie's Imports, Inc.
Parts Mgr: Dan Kuether
12520 Wayzata Blvd.
Minnetonka MN 55343
612-544-0376, MN 800-742-5764
US 800-328-5714
Saab dealer
- MN Mothers Motors
Ron Converse
350 Medina St.
(County Rd. 19)
Loretto MN 55357
612-479-2262
Ind. Import Repair
- MN Andrews Auto Rebuilding
Charles Andrews
Route 4, Box 247
Brickton Road
Princeton MN 55371.
612-389-3805
Saab body shop & used cars
- MN Viking Parts & Repair
Parts Mgr: Elmer Salo
Route 4, Box 247A
3 Brickton Road
Princeton MN 55371
612-389-3776
Saab Parts & Repair
- MN The Phoenix
Bob Labresh
3715 Oregon Ave. S.
St. Louis Park MN 55426
612-933-7284
Ind. Saab repair
- MN Shockley Motors
Phil Shockley
2605 County Road H
(New Brighton)
Minneapolis MN 55432
612-784-5432
Ind. Saab mechanic
- MN Swedish Express Inc.
Mark Strohm
Mechanics: Jeff Rapp
335 S. 1st Ave. E.
Duluth MN 55802
218-722-1530
Saab & Volvo repair & parts
Hours: M-F 8am to 5:30pm
- MN Twin Port Collision Repair
Steve Nelson
Parts Mgr: Brad Anderson
1831 W. 1st St.
Duluth MN 55806-
218-722-6266
Body shop
- MN Odberg Ryan Saab
Parts Mgr: Gene Leopold
2224 W. Superior St.
Duluth MN 55806
218-722-3317
Saab dealer
- NC Townsend Imports
Thomas Townsend
944 S. Chapman St.
Greensboro NC 27403
- NC Eurasian Import Center
Charles 'Bucky' Curtis
105 W. Greenville Blvd.
Greenville NC 27834
(919) 756-2705
Ind. repair shop
- NE Auto Tech
Dan Bruckner
2611 N. 84th St.
Omaha NE 68134
Ind. Saab Repair
- NH Hookset Saab
1 Kennedy Drive
Hookset NH 03106
Ind. Saab repair
- NJ Parkfield Motors
232 N. Washington Ave.
Bergenfield NJ 07621
201-385-7736
Saab dealer
- NJ Jerseyville Automotive
Howard Long Jr.
56 Jerseyville Ave. (Rear)
Freehold NJ 07728
201-308-0120
Ind. Saab repair
- NY Lighthouse Motors, Inc.
Danbury Road
Route 6
Brewster NY 10509
914-279-8066
Saab dealer
- NY Dr. J Foreign Cars
Jamie Solberg
Route 25A
Mt. Sinai
Long Island NY 11766
516-928-6626
Ind. Saab repair
- NY Baldwin Foreign Auto Repair
Bruce Baldwin
P.O. Box 32
New Lebanon NY 12125
518-794-8729
Ind. Saab repair
- NY Brownell Motors, Inc.
Mechanics: Pat
P.O. Box 413
Route 52
Fishkill NY 12524
914-831-3000
Saab dealer
- NY Swedish Automotive Inc.
Dana Hart
971 Spencer St.
Syracuse NY 13204
- NY Henneken
Guido Henneken
17 Washington
Binghamton NY 13901
772-9844
Import car repair
- NY A-Roar Imports
Peter Allen
19 Kelter Court
East Aurora NY 14052
- NY Motor Sport Service
Jack Lawrence
Parts Mgr: Pat Lawrence
1400 E. Second St.
Jamestown NY 14701
716-665-4200
Ind. Saab repair
Sonett, 99 specialists
- NY Foreign Motor Repair
Nicholas Pellegrino
282 Enfield Main Road
Ithaca NY 14850
607-272-8259
Ind. Saab repair
Hours - M-F 8am to 6pm
- OH The Swedish Solution Inc.
Dan Schindler
Parts Mgr: Erny Colonga
Mechanics: Bob, Alan, Gary
27999 Miles Road
Orange Village OH 44022
216-248-1022 in Ohio
800-556-PART U.S. order line
Saab Parts & Service
- OH Wolf Import Motors, Inc.
Parts Mgr: Robert Childs
1605 Mentor Ave.
Painesville OH 44077
216-354-5689
216-951-SAAB, Cleveland no.
Saab & Subaru dealer
- OH Anycar Automotive
John Negus
687 E. 152nd St.
Cleveland OH 44110
216-851-5661
Ind. Saab & BMW repair
- OH Elite Motors (DeFeo Saab)
5640 Whipple Ave. N.W.
North Canton OH 44720
216-497-0448
Saab dealer
- OH Scandinavian Motors
1635 Madison Road
Cincinnati OH 45206
513-221-SAAB (-7222)
Ind. Saab repair

- OR T. Scandia Motors
11133 S.W. Greenburg Rd.
Tigard OR 97223
503-684-6465
Ind. Saab repair
M-F 8am-7pm, Sat 8am-4pm
- PA Dennis Sweeney
207 E. Church St.
Ligonier PA 15658
412-238-4556
Used Saab parts
- PA Country Motors Inc.
Mechanics: Albert Sefcik
620 Evans City Road
Butler PA 16001
412-482-2156
Saab dealer
- PA Shugart's Auto Service
115 E. Strawberry Av.
Mechanicsburg PA 17055
717-697-4913
Ind. repair
- PA PARRformance
Rick Parr
Parts Mgr: Trevor Thomas
Mechanics: Tim Brown, Tony Aeillo
1229 Brunnerville Road
Lititz PA 17543
717-627-7222 (-SAAB)
Ind. Saab & Volvo repair
New & used parts
- PA Swedish Motors
Rich Kushner
573 Essex Street
Essex & Decatur
Marietta PA 17547
717-426-2202
Ind. Saab & Volvo repair
- PA Swedish Underground
Lee Smith, Owner
2112 Lycoming Creek Road
Williamsport PA 17701
717-322-6077
- PA Moser Import Service
Bill Moser
P.O. Box 401
Pt. Pleasant PA 18950
215-297-8000
- PA Victor Sports Cars, Inc.
Parts Mgr: Daniel Stella
1125-35 Easton Road
Abington PA 19001
215-886-8660
Saab dealer
- PA Bob Yates, Inc.
Parts Mgr: Dave Andrews
1222 E. Lincoln Hwy.
(U.S. Hwy 1 & I-95)
Langhorne PA 19047
215-752-3000
Saab dealer
- PA Clews & Strawbridge
Steve Boody, Service Mgr.
Parts Mgr: Jim Malin
310 Lancaster Pike
Frazer PA 19355
215-644-5054 service
Saab dealer
- PA Werner Motors Saab
Alan Werner
1250 N. Broad St.
Lansdale PA 19446
215-855-9077
Saab dealer
- PR Stuttgart Motors
Avenida Kennedy
Puerto Nuevo PR 00920
809-781-0102
Saab dealer
- SC Sports Car Centre Ltd.
Richard Koenig
Laurel Bay Road
Beaufort SC 29902
803-846-4884
Ind. Saab Repair
- SD Lambs Automotive & Radiator
Tom Lamb
920 - 2nd
Sturgis SD 57785
605-347-3449
Ind. Saab repair
- TX French's Foreign Car Service
Tom French
925 Luke Street
Irving TX 75061
214-399-1222
Ind. Saab repair
- TX Phoenix Motor Works
Terry Sayther
1508 Fortview Road
Austin TX 78704
312-442-1361
Ind. Saab repair
- UT Boyd Davis
165 W. 9210 So.
Sandy UT 84070
801-255-7200
Ind. Saab mechanic
- VA David Baugher
9704 Lownd Dr.
Manassas VA 22110
703-369-7325
2-stroke crankshaft rebuilding
- VA BSR Imports, Inc.
315 W. Main St.
Charlottesville VA 22901
804-296-1110 Service
804-977-6760 Sales
Saab dealer
- VA Loki Automotive
Ted Tucker
Box 68 Route 1
Earlsville VA 22936
804-973-5298
Ind. Saab repair: 93 thru 97
2-stroke & V4 only
- WA Rowland Motors, Inc.
Parts Mgr: Rich Roberts
517 East Pike Street
Seattle WA 98122 3696
206-328-2303, 800-562-5510 (WA)
800-426-2202 U.S. order line
Saab Dealer
V4 parts specialists
- WA Fairchild European Auto
2011 Iron St.
Bellingham WA 98225
206-671-6190
- WA Circle & Square Imp. Car Serv.
Alex Fowler
2621 Cape George Rd
Port Townsend WA 98368
- WI Gesch Enterprise
Larry Gesch
4445 N. 124th
Brookfield WI 53005
414-783-5530
Ind. Saab repair & parts
- WI The Foreign Car Repair Shoppe
Mike Mathias
2345 W. Mill Rd.
Milwaukee WI 53209
414-228-7511
Ind. Saab mechanic
- WI Tosa Imports
Parts Mgr: Mike Etzel
6102 W. North Ave.
Milwaukee WI 53213
414-771-2340
Saab dealer
- WI Sullivans II
Jack & Scott Sullivan
Baraboo WI 53913
- WI Import Motors
315-B E. Madison St.
Eau Claire WI 54703

FINNS FIND LEWIS FANTASTIC

Racing against some of the best northern European race drivers, 1986 Barber Saab Pro Series Champion Willy Lewis of Portland, Maine, recently was able to show that Americans can drive fast on ice too. In a race in the Finnish Saab Championship, featuring identically prepared Saab 900 Turbo Sedans, Lewis placed second.

On a lake at Lohja, outside of Helsinki, in temperatures around the 20 below mark, Lewis pitted his skills against some very fine talent including John Llewellyn of Great Britain, winner of the British Saab sedan championship; Sweden's Anders Norstedt, the reigning European Rallycross champion; Jouko Kallio, 15 time Finnish driving champion; Timo Reini, Finnish Ice Racing Champion; and Markku Kussijarvi, currently the points leader in the Saab series.

As Lewis enthused, "These were the best drivers I've ever driven against... the level of professionalism is unbelievable."

Despite the bitter cold, the event had drawn some 5,000 spectators and no less than 150 competitors to the frozen lake. To gain a place in the feature race, Lewis had to run his Saab in both qualifying heats and a semi-final. He easily made the feature's starting grid, and when the green flag fell, found himself in a drag race to the first corner with eventual winner Kuusijarvi. Unable to beat him into the turn, Lewis was relegated to an unsuccessful race long chase in the snow dust behind the leader.

Lewis also did some driving in the Ice Challenge Endurance series in Minnesota and Wisconsin. The car was one of the Stock class Archer Racing Chevy Spectrum Turbos. He won the warm weather shortened Mankato, MN, race, and co-drove to a second place at LaCrosse, WI, with Steve Potter.

MURILLO TAKES TWO

Ken Murillo has taken a strong early points lead in the 1987 Barber Saab Pro Series by winning the first two races. Murillo won both the Miami and Road Atlanta races, but only by fractions of seconds. Details on the first several races in a future issue of NINES.

WORKERS WANTED FOR PENN RALLY

Saab Club members will again be acting as stage workers at the Susquehannock Trail PRO Rally in Wellsboro, PA. The rally is held the weekend of June 5-7th. If you are interested in being a part of this group, and seeing the top rally cars and drivers in the U.S., contact:

Gary Thomas
113 Irving Place
Ithaca, NY 14850
(607) 277-0501

Passive Restraint System Features

SAAB

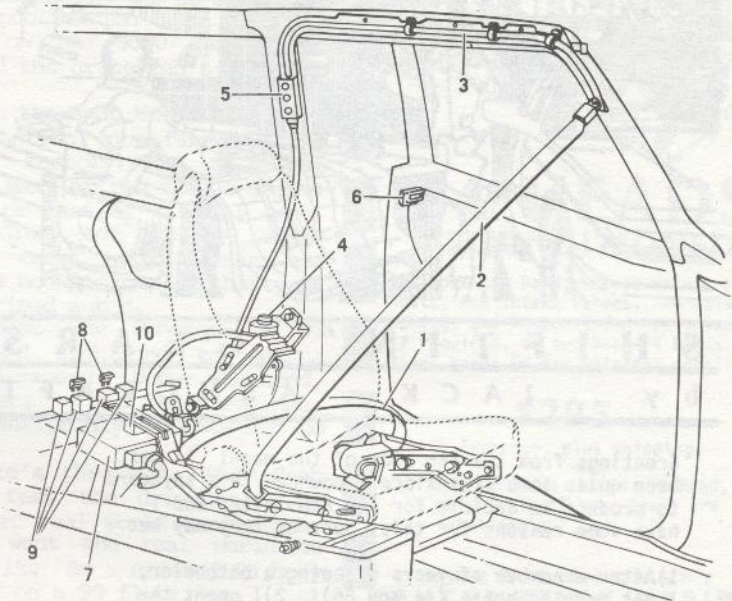

1. Manual lap belts, the inertia reel is mounted on the seat frame.
2. Passive shoulder belts—the inertia reel is also mounted on the seat frame and includes a sensor which tells the ECU if the belt is retracted or extended and a solenoid which allows the ECU to override the normal belt locking mechanism when adjusting the seat position.
3. Transport mechanism guide rail, mounted on roof and pillars.
4. Transport mechanism drive motor—includes a built-in limit switch to turn the motor off when the belt reaches the A-pillar.
5. Belt lock—provides a secure anchor point for the belt at the B-pillar. Includes a limit switch to turn the drive motor off.
6. Door lock position sensor—this switch is triggered by movement of the door lock in much the same manner as the "door ajar" system on the 9000.
7. Electronic control unit—shares the same 25-pin connector and outward appearance as the APC and Lambda boxes.
8. Fuses, 25 amp—each supplies power to one drive motor.
9. Relays—a pair of five-pin "either/or" relays per drive motor. Each relay alternately supplies power or ground to the motors as a means of reversing rotation.
10. G-force sensor—in the event of a collision, this sensor will interrupt a 12 volt signal to the ECU preventing the shoulder belts from releasing if the door is sprung open or the wiring harness is damaged.

99 PAINT JOBS

I am interested in hearing from anyone who has received, or been turned down for, one of Saab's paint jobs on the '76-'78 99s. They turned us down saying the original owner purchased the car before 1/78. My car is a '77 99EMS whose VIN fits Saab's requirements. Date of purchase seems to me to be irrelevant!

[Last year, Saab-Scania agreed with the Federal Trade Commission (FTC) to repaint certain cars sold after December 31, 1977. The cars affected were built at the Saab plant in Belgium, and can be identified by the VIN number, the fifth digit of which should be a "7".]

Lewis Eig
36 Fawn Hill Dr.
Monsey, NY 10952

CLOSEOUT ON CONVENTION GOODIES

'86 T-Shirts (M, XL only)	_____	\$6.00
"Troll" T-Shirts (M, L, XL)	_____	\$7.00
'86 Convention Posters	_____	\$2.00
"SAAB CLUBS" Lic. Plate	_____	\$4.00
"SAAB CLUBS" Lic. Bracket	_____	\$3.00
(Specify Model & Year)		

Add \$2.00 Shipping Per Order.
Send To:

SAAB CLUBS OF GEORGIA
1491 Howell Mill Road
Atlanta, GA 30318

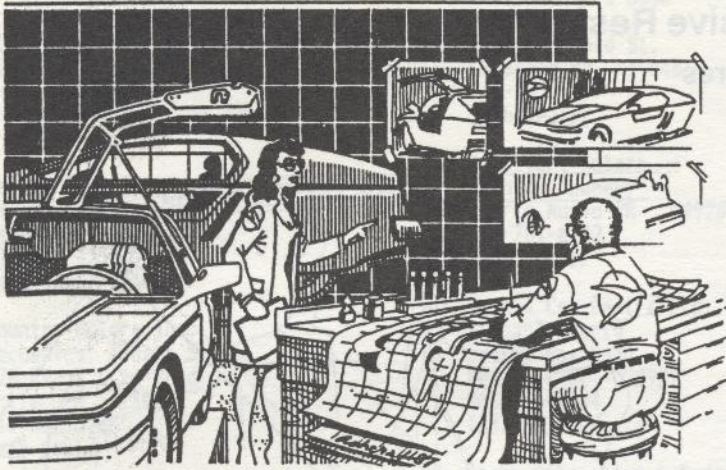

S H I F T I N ' G E A R S

by JACK ASHCRAFT

Greetings from the far side of the moon! It has been quite some time since I pounded this keyboard to produce an article for the Newsletter and I have some reasons for this, poor as they may be:

1) After a number of years of being a bachelor, I got married again (in Nov 86)! 2) I spent the largest part of 1986 on three major Saab restoration projects (a 95, a 96 and a Sonett), and 3) I have done some major realignments of properties and massages of taxes for 1986-87. Very little time was left over for ANYTHING, including the SAAB Newsletter. But, as things will, all has settled down once again and I can do some "regular" things once more.

Several things learned during the restorations were: 1) the price of restorations has taken a sharp upturn due to the cost of parts going up dramatically due to currency fluctuations. 2) You can no longer buy the brake light switches for Sonetts. Solution was to install a purely mechanical switch that operates when you depress the brake pedal all right but because the pedal moves a switch physically and not hydraulically. The switch is off a Honda and mounts on the bracket that was formerly used to hold the switch that turned on the low brakes warning light. This is located between the brake and the throttle, under the sheet metal plate on the floorboard. 3) Michelin MXL tires in a 175/70SR-15 are a wonderful replacement tire for the late Sonett, which has the offset aluminum rims. The offset rims assure that the wide Michelin tire doesn't rub the coil spring in the front. Adequate tire clearance is maintained all 'round. Best prices were from TELETIRE, a mail order outfit that regularly advertises in Road & Track, Car & Driver, etc. These are the same tires as fitted in stock trim on my new Ford Tempo GL Sport and on either car they hang on tenaciously in either wet or dry conditions, seldom squeal even when pushed quite hard, and give impressive stopping in wet or dry. Here is a case where a modern tire can dramatically up-grade an older car. They ARE wide enough in section that they would be a problem on standard 95/96/97 rims. The late aluminum Sonett (or similar) aluminum rims are a must.

About those pesky tail lights....

Any of us who have had Saab 99s and the later Sonetts know that the tail lamp/stop lamp/ back-up lamp/license lamp bulbs all seem to get mysteriously loose in their sockets and stop working--just about the time that snotty little town cop is following us. One of the members suggested changing all the sockets and that will certainly solve the problem. An interim fix can be done by taking a piece of clothes hanger wire and making a 90 degree bend in the end of it, with the bent piece being left about 1/4" long. Make sure the lights are OFF, take off the lens, take out the bulb(s), and reach into the socket with the bent wire. Hook it behind the brass connector piece, and pull the brass connector as far out into the socket as you can with the wire. Clean up the bulb, shoot a bit of contact cleaner onto the bulb and into the socket, and replace everything. It will work until the next time the brass contact gets tired (which may be some months) and then you can repeat the process.

Sonetts and headliners....

Most Sonett headliners have either come down about your head and shoulders or else will soon as the old Swedish glue gives up the ghost and the thin sponge rubber between the upholstery and the glue deteriorates. When you replace it, you can leave the front and rear glass in place if you want to. Simply push back the rubber seal at the glass and cut the old upholstery loose with a razor knife. Pull the windlacing down above the doors. Pull out the headliner. You will have to remove the roll bar. Fit the new headliner. I contact cement mine in with the help of a second person. Get it centered in the car and put it in place, working from the center of the top outwards in all directions. When you get to the windshield glass, trim back the new upholstery so it will tuck under the rubber seal at least 3/8". Pry back the seal and smooth the headliner material in behind it. Repeat the process at the back window. Wrap the headliner around the sides above the doors the way the old headliner was put in. Replace the windlacing around the doors and the roll bar and the job is done. The expensive glass is not disturbed and your pulse rate stays down where it is supposed to be.

On Sonett Roadsters....

Just re-read George Vapaa's article (Oct 86 Newsletter) on his Saabster. I have a 72 Sonett with its insides burned out that could benefit from a similar fix. I plan to rework it but have not decided whether to do it as 1) a Saabster like George's, 2) a very modern T-top coupe with full rear skirts and a targa roll bar, 3) a soft, rounded, late-50s Italianesque coupe, or 4) a whole hog revamp to look like a late 30s Alfa or Talbot Lago in 3/4 scale. Stay tuned.

Jack Ashcraft

GOOD & BAAD BOOKS ON SAAB

SAAB 9000 turbo/9000i

by Marcello Pirovano

It looks nice on the coffee table. That's about the most positive thing that can be said about this Italian publication, one of the Supercar series of books published by Automobilia. The text is in three languages, Italian, English and French, which means each language takes one third of the allotted word space. At only 96 pages, with lots of photos and drawings, there aren't many words. The entire book can be read in under two hours.

It's pretty, with lots of color photos and multi-color drawings that make it more of a "browse" book than a reference. But all those drawings look mighty familiar. The final page tells the story. "The publisher would like to thank Sidauto S.p.A. for permission to reproduce a few drawings from the Saab 9000's use and maintenance manual." They've been lifted from Saab-Scania AB's own publications (see below).

To be fair, there are several pages of early design drawings and photos from Giorgio Giugiaro's Ital Design studios, along with quotes from Giugiaro on how the 9000's personality was developed to differentiate it from the Lancia Thema and Fiat Croma. There is also a "driving impression" section, which gives a few of the high and low points of the 9000 on the road. But the majority of the book relies on artwork direct from Saab-Scania.

At \$34.95, this is certainly not a quick purchase item. For those who have easily expendable income, or who must have every book written on Saab or the 9000, it is a nice addition to the home library. The high price must come from the quality of the paper and binding, because there isn't much in the way of research. You might want to wait awhile, as this is the type of book to show up on the "publishers' closeout" tables at the local bookstore.

SAAB 9000 — Engineering Features

The 1987 version of this "brochure" (as it is called on the title page) is just over 100 pages in length and gives the company impression of their top-of-the-line model. It is easy to read, has a full Index and Technical Specs section, and plenty of easily understandable drawings, diagrams and photos. Best of all, it's free from your local Saab dealer.

The engineering theme begins on the cover with a computerized drawing of the 9000 in front view. The book is broken into five major headings; Performance, Roadholding, Comfort/Safety, Form/Flexibility, and Quality. At the beginning of each section is a quote from the review of a top international car magazine. Following each section is

a summary of the characteristics in outline form. In between is the reasoning behind virtually every function of the 9000. It is also up to date, covering the 9000S and the 4-speed automatic transmission.

Sure, it's "the company story" and all that, but until someone puts together several chapters on the car's development, it is probably the best publication that will be available on the 9000 series for awhile. And the price can't be beat.

The Cars in the Saab Museum

In Trollhattan, not far from the main Saab factory, is a museum containing many of the famous Saabs; the first or last of a model line, design studies, and factory racing and rally cars. Saab-Scania has published a book featuring thirty of these enshrined autos.

You'll meet The Monster, a 93 stripped and lightened to set a world speed record. Under the hood, six cylinders -- two 748cc engines, mounted transversely, crankshaft to crankshaft.

Then there's the Toad. When Saab wanted to test the drivetrain for the 99 under real world conditions, it didn't want the real world to know about it. So a widened 96 body was mounted on a 99 floor pan.

Ever wonder what became of Saab models 94 and 98? They're in there, too. The 94 was the original Sonett, while the 98 was a hatchback design similar to the 99 Wagonback for the 96 series.

The book is all in English, with many color photos. A nice addition to any Saaber's bookshelf. The only problem is you can't buy it in the U.S. It is available only at the Saab Museum. Just one more reason to visit the home of Saab in Sweden.

Service Information Manuals

Independent Saab repair shops and backyard mechanics who like to keep on top of any updated information published in addition to the Factory Repair Manuals can purchase the five volume Saab Service Information Manual Set. The set consists of the five S.I. Supplement books covering all S.I.s from 1971 through 1985, plus Service Tips and Recall Guides. Though Saab does not have a list price for the set, it should retail for less than \$100. If you don't want the entire set, individual S.I. Supplements are also available. Part numbers and suggested retail prices are listed below. The dates are when the S.I.s were published, not dates of models covered.

Supp#	Dates	Part No.	Price
#1,	1/71-10/79	02-90-957	\$16.90
#2,	11/79-8/81	02-91-286	17.70
#3,	9/81-12/82	02-91-369	13.45
#4,	1/83-10/84	02-98-711	13.45
#5,	11/84-12/85	02-77-244	15.25
Complete Set		02-90-155	---

These books may be ordered through a Saab dealer. Contact your local SAAB Parts person for details.

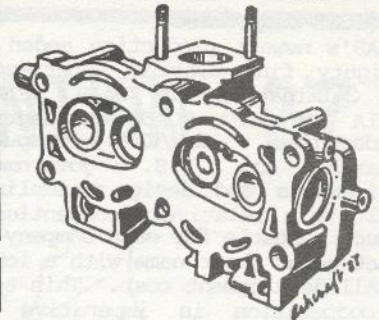

V4 HEADS RECONDITIONED

Includes new hard exhaust valves and seats, new intake valves, new valve springs and keepers, and new guides if required, on two Saab V4 heads. These heads OK for unleaded gasoline.

\$295

Exchange, plus shipping.

Add \$50 core charge per head, refundable if your heads are rebuildable.

**JACK ASHCRAFT
AUTOMOTIVE DESIGN
270 WILSON ROAD
CENTRAL POINT, OREGON 97502
503-779-0731**

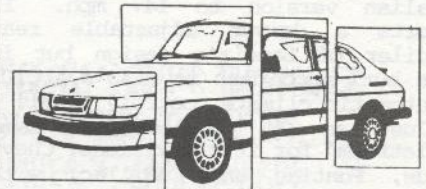

PARTS

EUROPEAN
AUTOTEILE
INC

DISCOUNT PRICES ON
NEW, USED, REBUILT PARTS & ACCESSORIES

- BODY PANELS
- ENGINES
- TRANSMISSIONS
- UPHOLSTERY
- SUSPENSION COMPONENTS
- CLUTCH KITS
- TURBOCHARGERS
- COMPLETE LINE OF ACCESSORIES

EVERYTHING FOR YOUR SAAB!

WE SHIP DAILY • OPEN SATURDAY

1311 67th ST. • EMERYVILLE, CA 94608

(415) 654-9121

U.S. TOLL FREE ORDER LINE

(800) 621-0851 ext. 111

NOTES FROM THE COUNTRY SAAB STORE

The Great Compromise

SAAB's newest production sedan is a mighty fine driving experience. The Culmination of SAAB, FIAT, LANCIA and ALFA ROMEO engineering philosophies, CAD/CAM computer research and U.S. government requirements and design guidelines result in a relatively conventional product suitable for each company to market under their name with a lower overall development cost. This type of cooperation is imperative to smaller companies, financially speaking. New model research and development is very costly and is considered a gamble.

This four way design forms a less expensive but all new platform for the individual manufacturers to highlight and complete with engineering and details which reflect the opinions and ideas of their respective "in house" engineers.

The SAAB 9000 was the first of the four to be sold to the public. SAAB's version, although keeping the "strut" front suspension after years of proper double A-arms, utilized the solid beam axle in the rear, rather than the independent suspensions of the others.

The Swedes put their mark on their version just as FIAT and the rest did theirs. The SAAB 9000 TURBO is no longer the most powerful of this family of front wheel drivers. The Lancia Thema 8.32 is powered by a Ferrari built V-8 pulling the Italian version to 147 mph. It sports a driver adjustable rear spoiler of Lancia's design but in the burl wood dash is SAAB's A.C.C. (automatic climate control) panel!

Just as GM produces the same "platform" for its divisions; Chevy Olds, Pontiac and Cadillac, with each putting its own identity around similar internal structures, so have many other manufacturers from different nations. We can now purchase a Toyota called Nova produced by NUMMI (a joint GM/Toyota combine in California), a Honda called a Rover, a Peugeot called a Citroen, the list goes on. The world is growing smaller as a matter of economics. Ever increasing government regulations contribute to co-op development and could be blamed for the lack of small innovative car manufacturers, and the obvious "cloning of cars". It's been said by many automotive experts that by the turn of the century over half the car companies we know of now will be swallowed up by the larger conglomerates or simply close their factories permanently.

The Meddling Bureaucrats

EPA, DOT, NHTSA, CAFE, the Claybrooks and Naders have succeeded in depriving us of automobiles of character. A fresh idea or innovation is scrutinized, criticized or scratched from the drawing board due

to the conformity laws the "do-gooders" have dreamed up. Enthusiasts and manufacturers alike groaned in 1968 as we lost the anachronistic but entertaining Austin Healy 3000, the loveable Mini Cooper and other cars of character. Ever tightening emission controls turned the barking four cylinder sports machines into wheezing temperamental turtles. By the mid-70s companies like Citroen bid the U.S. market a disgusted adieu, depriving us of the fabulous and safe DS and the advanced SM. Battering ram bumpers and other federally mandated safety and emission laws were like steroids to formerly lean and graceful driving machines. Old existing designs gained weight; add on emission controls reduced fuel economy and power.

Soon most car manufacturers began with clean sheets of paper as the dust settled and we began to accept the government's requirements. As a result, fuel injection replaced the carburetor, new engine designs integrated the clean burn efficiency, bumpers, beams, side markers, etc. were designed in, not tacked on. Crash standards and strict fuel economy limits brought computer assisted "strength with light weight" engineering. The CAFE (Corporate Average Fuel Economy) standards are now easily met by large manufacturers. If the average for a model year is 26.9 mpg, GM can, for example, insure that they'll sell enough Chevettes, getting an EPA laboratory rating of 42 mpg, to keep their CAFE up to standards. Even with the gas guzzling 15 mpg land yachts still being sold, GM thus conforms to the standard. Jaguar, Ferrari and Porsche pay outrageous fines each year for not meeting the standard required.

SAAB's product for the future years had to utilize all these requirements in the basic elements of conception. Computers were used to form the efficiency of the conceptual car. Sixteen Sason in the 99/900 design helped engineers build a structure heavier than necessary. The overbuilt sturdiness of their car was not limited by manufacturing costs and efficiency experts. Made up of many small stampings of various thickness and welded into one unit, many times by hand, produced a very safe strong (though somewhat heavy by today's standards) automobile.

Our beloved 96 was dropped in 1980 not due to lack of interest but because of its cost to profit ratio. It was not feasible to continue to build this thirty year old design, sell it at a competitive price and still make a profit. This can and may spell doom for the 90/900 series. It actually cost SAAB less to produce a 9000 shell from a few large stampings than a 900 with its numerous compound assemblies.

The computer is the efficiency expert. It knows the structure has to absorb enough impact to meet basic crash standards. Then considering light weight and ease of assembly the form becomes a compromise. Its final blueprint for a panel must never be over built, too heavy or too complex. The computer cannot understand the logic behind the heavy gauge boxed windshield pillars of the 90/900 when it can "pass the test" by bonding the windshield to two stampings of roof and pillars. The computer doesn't care if the strength does not exceed expectations, it's content with "just good enough".

The Real World

Anyone who has explored the structure of the 90/900 and the 9000 could understand why crash tests of the latter proved that it's less than impressive. The long nose of the 900 and its inline engine provide much more impact force absorption than the short nosed, transverse layout of the 9000. Though the 9000 utilizes space in a most efficient manner compared to the similar sized 900, it lacks the extra margin of safety the old design has. Take note: Once the windshield is removed from a 9000, the car's structural rigidity is so drastically reduced that it should not be moved or it will flex and deform!

Calculated data aside, a report in the March 23rd **Automotive News** states that two General Motors staff engineers were killed in a head-on collision of their rented Saab 9000 and a BMW 7-series car driven by a BMW test driver. The two individuals testing the BMW were not seriously injured. The accident occurred in Sweden in an area often used for cold-weather testing of cars.

Living In The Past

My seven year old son is just as intrigued and entertained with the electronic controls and displays in a 9000 as he is in a 93, choke out, pull starter yanked, and it pops to life. Each and every progressive change and advancement in technology has produced bittersweet results. If, as purists, we allow the 9000 to mature as we did when the 93 became the 96, which became the V4, when the 99 stirred us all up in 1969, and the 900 Turbo put SAAB in the spotlight, it can be the SAAB for our future. It's a blast to drive, roomy as a bus and needs less mechanical attention than a lawn mower. The gearbox doesn't leak and blow holes in its case, it doesn't boil over in a summer traffic jam, fuel economy is tops with more power than ever and its styling won't grow old. Let's hope it doesn't rust like an Italian car.

Rick Parr
PARRformance
"the Country SAAB Store"
Lititz, PA

NATIONAL SAAB OWNERS CONVENTION '87

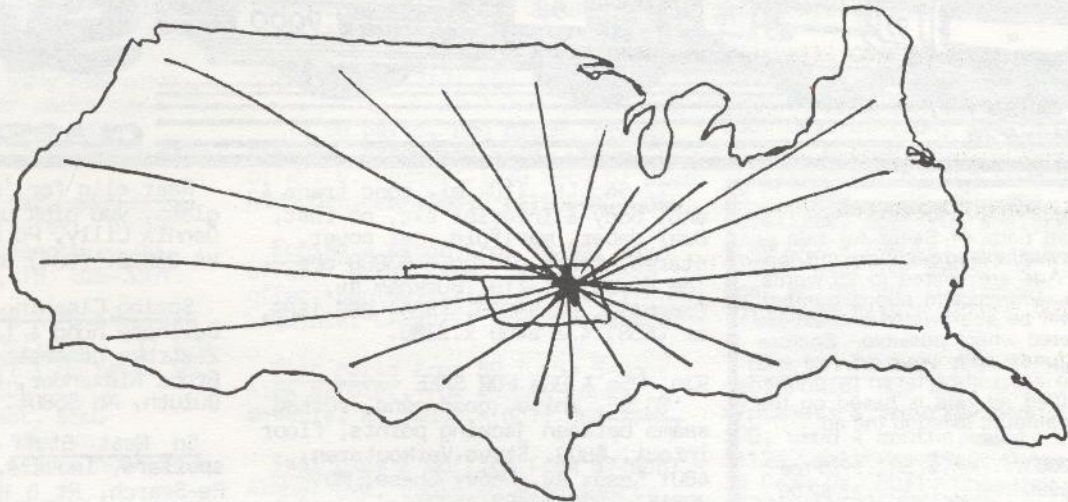

JULY.. 24TH , 25TH & 26TH... 1987 TULSA, OKLAHOMA
 CONVENTION FEES: \$50.00 PER PERSON - AFTER JUNE 1ST 1987 (SEE SPECIAL BELOW)

FEE INCLUDES: FRIDAY EVENING GET AQAUINATED PARTY W/ FREE BABY-SITTERS
 SATURDAY CONTINENTAL BREAKFAST, SWAP MEET, TECH SESSIONS, CONCOURS
 BOX LUNCH, ROAD RALLY, FREE TIME, SIGHTSEEING, SPECIAL EVENTS,
 AWARDS & BANQUET W/ FREE BABY-SITTERS.

SUNDAY CONTINENTAL BREAKFAST W/ TECH SESSION INSTRUCTORS'. EDITOR TIM WINKER
 SPECIAL EVENT: GUM BALL RALLY FOR SERIOUS RALLIERS, ONLY 30 CARS TO ENTER
 REGISTRATION FEE: \$10.00 (1ST 30 TO REGISTER) TROPHIES & CASH AWARDS

ALL ROADS LEAD TO TULSA, OK. IN JULY '87

LIST SEPARATELY

REGISTRATION FORM

NIGHT PHONE A/C.

NAME

ADDRESS

CITY

STATE

ZIP

SPECIAL RATE: \$ 45.00 PER PERSON ... BEFORE JUNE 1ST 1987
 \$ 50.00 PER PERSON ... AFTER JUNE 1ST 1987

ENCLOSED \$ ____ .00

SPECIAL EVENT: GUM BALL RALLY \$10.00 PER CAR YES/NO

MAKE CHECKS PAYABLE TO "TULSA SAAB CLUB"

SEND TO: JIM GLAVAS

2705 SO. 74TH E. AVE. TULSA, OK. 74129

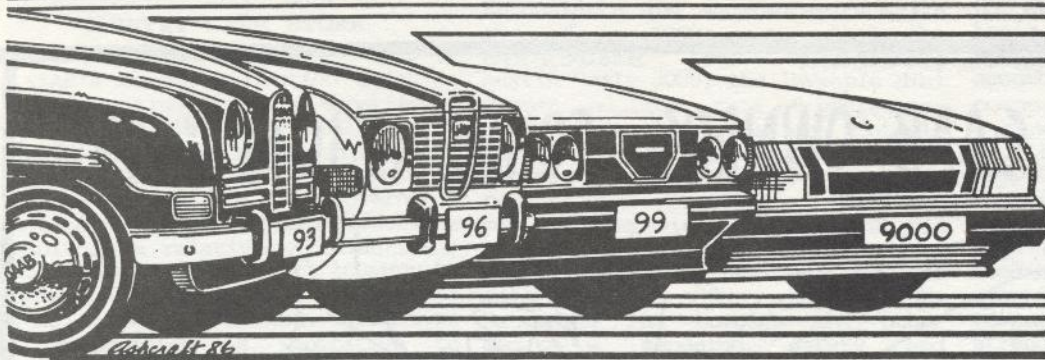

SAAB SWAP

CLASSIFIED ADS

CLASSIFIED AD RATES

Ads offering parts or Saabs for sale or wanted are available to members and non-members. Ads are limited to 25 words, plus name, address, and phone number. Ad copy will be abbreviated and excess words deleted where possible. Enclose sufficient funds with your ad, we will not bill. No ads will be taken by phone. The Classified ad rate is based on the total dollar amount listed in the ad.

Under \$200	Free
\$201 to \$900	\$2.00
\$901 to \$2000	\$5.00
Over \$2001	\$10.00
Ads without a price listed ...	\$10.00

DEADLINE: Second Friday of each month for the following month's issue, i.e. the second Friday in January for the February issue.

COMMERCIAL ADS: Contact Editor for rates and info. Deadline, First Friday of each month for the following month's issue.

SONETTS FOR SALE

'84 & '85. Full roll cage. Sister car to Jack Laurence's. Ready for engine & wheels. \$4800 w/eng, \$3800 w/o. Dave Miller, 5 Parkview Ave, W. Caldwell, NJ 07006. (201) 575-0150

'73 Sonett, only 200 miles on full race engine, king-kong trans, custom paint, AC, new interior, brakes, MSS exh, Konis, alarm, more. \$3900. Edgar Steele, 3211 Longfellow Dr, Belmont, CA 94002. (415) 594-0588.

'73 Sonett, engine runs fine, body in good condition, clutch work needed, trans overhaul 18k ago. \$1075 or best offer. William Gilland, Hudson, WI. (715) 386-7650.

'72 Sonett, orange, looks & runs great, 48K mi. Also '67 Sonett II, chassis #168, red, blown engine, otherwise good condition. Need garage space. First \$4500 takes both. Lori Imhof, 118 Camp St, Emmaus, PA 18049. (215) 965-6660.

'72 Sonett, 108k mi, good tires, mags, good compression, shaky trans. \$900 obo. Michael Nagatkin, 3901 NE 11th Pl, Renton, WA 98056. (206) 226-0770.

'72 Sonett, 110k mi, good trans & eng, body & interior exc, no rust, Dual Weber, manifold, car cover, stereo. Needs clutch. \$3000 obo. Tom Remedios, 1191 Bucknam Av, Campbell, CA 95008. (408) 866-1689, or (408) 432-9400 x.2380.

93s, 95s & 96s FOR SALE

'70 95, white, good cond, rusted seams between jacking points, floor intact, \$800. Steve Verkouteren, 4801 Essex Av, Chevy Chase, MD 20815. (301) 652-4492.

'67 95, very good drive train, rblt Sonett trans, V-4, MSS exhaust, body looks good, but has rust. \$800. Tom Kirkpatrick, 13873 Crey Colt Dr, Gaithersburg, MD 20878. (301) 340-6435.

'65 95, bright blue, 850cc tri-carb mixer, rblt crank, discs, very good cond but has had rust work. \$1200. Steve Verkouteren, 4801 Essex Av, Chevy Chase, MD 20815. (301) 652-4492.

Collector Clears Out... 95s & 96s, 2 strokes & V-4s. Conditions & prices vary. Write or call for details. Serious inquiries only please. Matt Steva, 6608 Portage Rd, DeForest, WI 53532. (608) 846-9332.

3 '67s, 2 V-4s, 1 2-5. Bad engine in 2-5 but body in great shape. One V-4 needs overhauling, one is for parts. \$350 for all. Rodney Owens, Rt 5, Law Rd, Jackson, TN 38305. (901) 423-0216.

2 STROKE & V-4 PARTS

Roof rack for 95/96, \$30 +shpg. Michael Nagatkin, 3901 NE 11th Pl, Renton, WA 98056. (206) 226-0770.

'74 Sonett NOS parts; 4 Bosch plugs, points, condenser, thermostat, rear axle mount, rear brake shoes (used), & Service manual, \$40 +shpg for all. Alex Gentile, 528 Circle Dr, Bridgeville, PA 15017. (412) 941-5320.

'72 Sonett parts incl all gauges, shift linkage, glass, lights, seats, fuel tank, window struts, & more. Must go by 8/1/87. W. Noel Einolf, 7519 Tanglewood Rd, Richmond, VA 23225. (804) 320-2371, 6-10pm.

Rear clip for '68 Sonett, no glass, you pick up. \$100 obo. Dennis Lilly, PO Box 1932, Grafton, VA 23692. (804) 898-4368, 10am-12pm.

Spring Cleaning Sellout - '64 Bullnose hood & tail lens set, \$35. 2-stroke generator/water pump, \$10. Bruce Alexander, 4719 Pitt, Duluth, MN 55804. (218) 525-2884.

So Neat Stuff for Sonett IIIs: spoilers, louvers, etc. Send SASE to Re-Search, Rt 6 Box 84, Alexandria, MN 56308

Air conditioner from '72 96. Best offer. Bob Heimer, 1036 Oneida Av, Davenport, IA 52803. Days - (319) 322-6216.

'72 V-4 engine & tranny in working order. \$75 each obo +shpg. Other V-4 parts too. Eric Way, Ithaca, NY (607) 277-3836.

99s & 900s FOR SALE

82 900 Turbo 4-dr, silver, 65k mi, good condition, \$7200. Dan Horton, 832 W Upham St, Marshfield, WI 54449. (715) 387-6085.

'77 99GLE, some problems in diff, but can be driven. \$350. Milton Davidson, 2193 Southeast Blvd, Salem, OH 44460. (216) 337-9260.

'75 99EMS, 107k mi, sunroof, AC, Konis, new front tires, runs good, some rust. \$1295. Marvin Conyers, 5879 Hempline, St. Louis, MO 63129. (314) 846-5651.

'75 99LE, 2-dr, 4-spd, new clutch incl hydraulics, rblt alternator, Texas car, no rust. \$1200 obo. Grant Gongoll, 109 W 36th St, Minneapolis, MN 55408. (612) 825-3191

'74 99LE, 4-dr, 4-spd, stereo, fogs, 83k mi. Clean rust-free Southern car. Recent alternator, headliner, tires, brakes, exhaust, battery. \$2100. Jim Laman, 763 Larkwood Dr, Holland, MI 49423. (616) 772-5002 days, 335-5215 eves.

'73 99LE, 4-dr, 4-spd, 121k mi, very good body, tach, recon head, new exh, new ft brakes, \$995. Marvin Conyers, 5879 Hempline, St. Louis, MO 63129. (314) 846-5651.

'72 99 113k mi, very little rust, strong eng but needs timing chain. \$300. Also parting out '73 99. Scott Sawyer, 4 Alderwood Rd, Auburn, ME 04210. (207) 782-0549.

'71 99E, EFI, 74 automatic, new brakes, shocks, water pump, timing chain. Has broken piston ring. Needs seat covers, minor body work & paint. No rust. \$900 obo. Tom Starr, Seattle, WA. (206) 767-0405.

'70 99 rblt eng, many new parts, marginal body, super parts car. \$300. Rich Kotlarz, Box 345, Warroad, MN 56763. (218) 442-5301.

'70 99, Colorado car, good body, runs poorly. Make offer. Julee Hammerberg, 715 Pleasantview Rd, Duluth, MN 55803. (218) 525-3301.

99, 900 & 9000 PARTS & ACCESSORIES
Spring Cleaning Sellout - '71 B-W automatic, \$50. '71 1.85 head, \$50. Freewheel trans, \$50. OEM chrome bumper set, \$50. 2 99 hoods, no mud, \$60 ea. EMS interior, best offer. Much more. All prices +shpg. Bruce Alexander, 4719 Pitt, Duluth, MN 55804. (218) 525-2884.

99 Parts, 69-78, 1.7, 1.85, 2.0L engines, trans (man or auto), compl units or parts, Body metal, glass, doors, susp, drivers & axles, gas tanks, bmprs, hdlt & t/l assy, P/S, A/C sys, interior parts, inj sys & parts, wiring harnesses, instrument panels, calipers, steering columns & racks, lost of misc 99 parts. Reasonably priced for quick sale. Neil Lindemann, P.O. Box 3153, Ann Arbor, MI 48104. (313) 994-5236.

900 and 99 parts, new cars every month. Black 99 Turbo, nice body and interior, you build power train. Any combo B-eng turbo/4-spd/APC eng/5-spd. 4 & 5-spd trans. '82 Turbo parts car, blue/blue. Alloy wheels. Set of SPG wheels, \$600, trades considered. Dennis Sweeney, 207 E Church St, Ligonier, PA 15658. (412) 238-4556.

900 thru 16 valve dismantled cars. Complete 16vLv setup, drivetrains for 900 & Turbos, new wheels, interiors, heads, radiators, power steering, dash, relays, rear clips, and much more. Michael Caro, 278 Boston Post Rd, Orange, CT 06477. (203) 795-0776.

Parts from '74 99L & '78 99GLE. Too numerous to list. Send SASE for list of parts & prices. James Mackay, PO Box 464, Wheaton, IL 60189-0464. (312) 668-4438.

'72 99 parts, eng block, crank, pistons, Stromberg carb. Make offer. D. Rosser, 1270 Sec. St Pike, Richboro, PA 18954. (215) 357-2062.

Engine & 4-spd from 76 99, make offer. Hatch from '78 99T, make offer. Dan Gallatin, PO Box 17, LaQuinta, CA 92253. (619) 564-4047.

Misc parts from 80 Turbo 5-door. Alex Barbier, The aplmer House, Waverly, NY 14892. (607) 565-2711.

Tail pipe & muffler from 87 900T. Almost new, replaced with sport muffler at 200 mi. \$100 firm. James Feinberg, Atlanta, GA. (404) 633-5776.

New Garrett Turbocharger with water jacketed center housing, fits 78-80, \$360. Turbo exhaust manifold, \$150. Tom Burton, Montague, MA. (413) 774-4515 days, 774-3260 eves.

Euro-style 9000 headlights, list \$161 ea, will take \$250 obo for set. Navin Dimond, 2075 S University Blvd, Ste #D-270, Denver, CO 80210. (303) 337-1746.

4 185/65x15 Hakkapelitta snow tires, 2 almost new, 2 half worn. Swedish Express, 335 S 1st Av E, Duluth, MN 55802. (218) 525-1530.

Pirelli 195/60VR15 tires, 1200 mi, list \$115 ea, will take \$85 ea obo. Navin Dimond, 2075 S University Blvd, Ste #D-270, Denver, CO 80210. (303) 337-1746.

4 New Mag wheels from 87 9000 Turbo. Use as extra set for rallying or winter. \$390 for the set. Richard Lyschik, 100600 Rock Run Dr, Potomac, MD 20854. (301) 299-9709 eves, 897-5666 days.

3 185x15 Pirelli P-8 tires, 20,000 mi. Hears like new. All 3 for \$80. Joe Jessen, New York, NY. (212) 250-0113 after 6pm wklys.

Pirelli CN36, 175/70x15, new, \$60. Sony XR75B head unit w/XM-21 amp. \$200 obo. 79 900T steering wheel, \$50. Dave at (304) 594-1900 6-10pm.

Clarion AM/FM cass from 87 Turbo, 18 presets, code, 80w amp, equalizer, spectrum analyzer w/manual & removal tool, mint. New, \$1200, sell for \$895. M. Uhryk, 50 Lost Hollow Rd, Dillsburg, PA 17019. (717) 432-9433.

Clarion factory AM/FM removable radio/cass, 80w amp, equalizer w/presets & security code, from 86 SPG, used 4 months, mint. List \$1125, sell for \$749. Peter Colpo, 24 Park Dr, RD#1, Cheswick, PA 15024. (412) 265-3008.

WANTED, ALL MODELS

Oil Warning Relay for oil injected 3 cylinder engine. Frederick Little, Heath Stage, Shelburne Falls, MA 01370. (413) 625-6184.

European headlights for 85 SPG. Will trade set of U.S. legal. Roland Halper, 33512 Periwinkle, Laguna Niguel, CA 92677. (714) 496-0464.

93 brake master cylinder (new) or rbltd kit, 93 taillight lens, 93 hood emblem, early style Sonett alloy wheels. Randy Cook, 58 Cinderella Lane, Ft. Walton Beach, FL 32548. (904) 863-3428.

Original upholstery material (fabric) wanted for Sonett III seats. Joe Osterbauer, 3505 Belden Dr, Minneapolis, MN 55418.

MEMBERSHIP/SUBSCRIPTION

NAME _____

ADDRESS _____

CITY _____ STATE _____ ZIP CODE _____

PHONE _____

SAABS OWNED _____

(Year & Model)

Please check appropriate box(es):

- FIRST YEAR \$18.00
- RENEWAL \$15.00
- CANADIAN Add \$3.00 U.S.
- INTERNATIONAL... Add \$7.00 U.S.

Individual back issues (from Jan. '86 on; no June, Aug./Sept. left) are available for \$1.50 each; 3 or more \$1.00 each.

- Collection of 10+ back issues \$10.00
- SAAB Club Decals, \$1.00 each.

SEND TO:

SAAB CLUB OF NORTH AMERICA
2416 London Road, Unit 900
Duluth, Minnesota 55812-2221

SAAB PARTS



HUGE INVENTORY OF FACTORY PARTS AND ACCESSORIES FOR V-4, 99, 900 and 9000

V-4 CATALOG, \$3.00
(REFUNDABLE)



517 East Pike Street
Seattle, WA 98122

"THE ENTHUSIAST PARTS STORE"

SAAB
ROWLAND MOTORS

U.S.A. PARTS ORDER LINE

1-800-426-2202

WA STATE PARTS ORDER LINE

1-800-562-5510

INFORMATION, SEATTLE LINE

(206) 328-2303

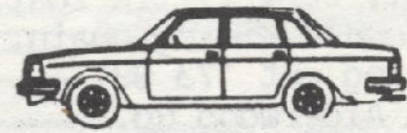

WEBER 34 ICH 1 BBL CARB
FOR V-4, INCL. LINKAGE .. \$150

Call for info on Weber 32/36 kit
for early 99s and "Big Throat"
for fuel injected 99s and 900s

SPORT CLUTCH PACKAGE — For
99/900; Rally, Autocross or
towing. Pkg. includes Disk,
Pressure Plate and Bearing.

'69 - '75 \$105.00

'76 - '83 \$95.00

KYB Gas-a-just shocks for 96,
Sonett, 99, 900

— PLUS UPS —

MASTERCARD & VISA ACCEPTED

SWEDISH EXPRESS, INC.

335 S. 1st Avenue East
Duluth, MN 55802
(218) 722-1530



2416 London Road, Unit 900
Duluth, Minnesota 55812

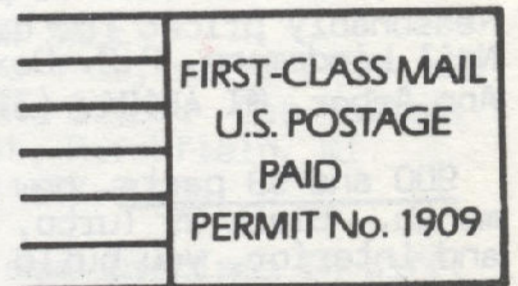

FIRST CLASS

MAY 1987

Exp: 87 12 R