

THE SAAB CLUB

NOVEMBER 1985, NEWSLETTER #142

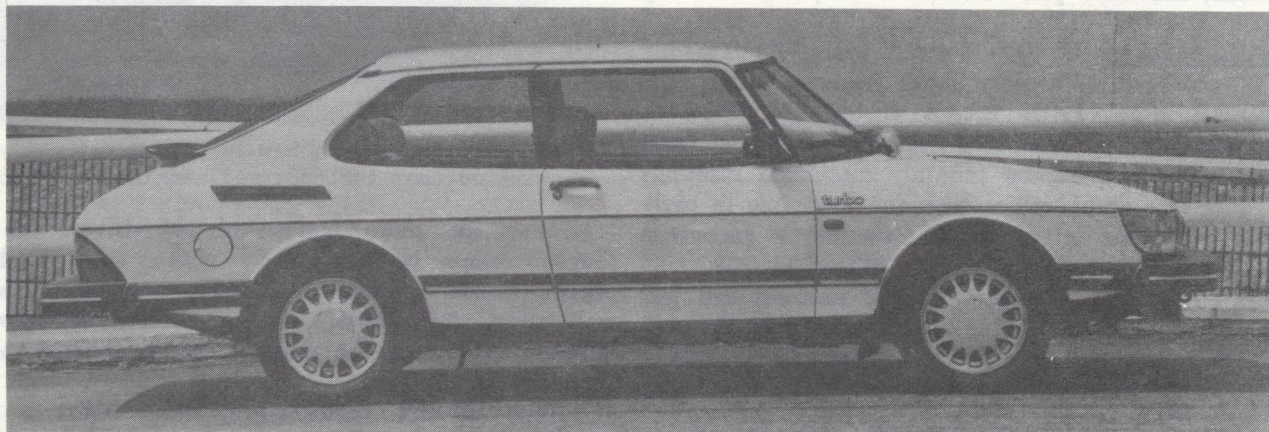

NEW 900's FOR 1986

Orange, CT -- The Saab 900 line is expanded for 1986 to include 3 body configurations and 3 engine choices. And for those patient enough to wait, a 900 Turbo convertible will be ready for summer.

This year the news from Saab is a second version of the 16-valve engine with twin camshafts, a naturally-aspirated (non-turbocharged) version, which powers the 1986 900S models. This engine has improved response at low speeds, giving the car smoother acceleration and reducing the need for gear-changing. So the car is easier and more satisfying to drive.

Inherent in the 16-valve engine design is better combustion efficiency. With 4 valves per cylinder, the spark plug can be placed in the center of the combustion chamber. This means that the fuel is ignited quickly and evenly: there are no hot spots in the combustion chamber and the compression ratio can be safely raised. And of course the higher the compression ratio, the better the efficiency.

The new engine boosts the horsepower of the 900S from 110 to 125.

To match the higher performance of its new engine, the Saab 900S rides on wider 195/60 R15 steel belted radial tires and the seats are the same deeply contoured bucket seats as in the 900 Turbo. Anti-theft radio

Standard equipment on the 900S includes sunroof, alloy wheels and an electronically-tuned radio with anti-theft circuitry that disables the radio until a secret code is typed in by its rightful owner. In addition, all Saabs are prewired for installation of a burglar alarm.

The 900S is available in 3 body styles: 2- and 4-door sedan and 3-door hatchback.

The 900 Turbo is even sportier this year with anti-sway bars front and rear and ventilated front disc brakes as standard equipment. The anti-sway bars improve handling by spreading the cornering force on all 4 wheels. As a bonus, this makes the tires last longer.

There are 3 versions of the 900 Turbo.

Purists prefer the base model, which most closely resembles the original Saab Turbo. It sports Saab's shark-tail rear spoiler, alloy wheels, black trim around the windows, and velour upholstery. Inside, the radio is completed by a graphic equalizer with an 80-watt amplifier.

NEW 900's continued on page 2

Saab Clubs of North America

Editor and publisher: Carolanne Curtis, 60 Charles St., S. Meriden, CT 06450
(203) 238-0508 9 a.m. — 8 p.m. except Sunday

Consultants: Dick Grossman, Jack Ashcraft, Ted Tucker & Rich Kushner.

CLUB NEWS

ATLANTA SAAB CLUB--Meets the first Monday of the month at ChiChi's, 5275 Roswell Rd NE, Atlanta. Dinner is from 7-8 pm with meetings starting at 8. Call Lou Savage for more info. 404-394-2310.

SAAB CLUB NATIONAL CAPITAL AREA--meets the Second Wednesday of each month at the Bethesda Regional Library, 7400 Arlington Rd. Bethesda, MD at 8 pm. For more info, contact Toby Turpin, 301-384-6732.

TULSA SAAB CLUB-- meets every 4th Tuesday at 7:30 pm at the Hardesty South Regional Library.

WEST MOUNTAIN SAAB CLUB (MASS.) -- had a fall rally on October 6 with individual and team events. We hold regular monthly discussion meetings plus quarterly event rallies with the next one in early Hanuary. Anyone interested in attending is encourage to do so. Contact David Sullivan 617-879-8288.

PENN-LANCO SAAB CLUB is forming and will meet the 1st Tuesday fo the month at Bube's Brewery in Central Hotel on Market St. 1 block off Rt. 230 in Mt. Joy, PA at 8 pm. For details call Tim Brown 717-627-2417.

OREGON SAAB CLUB--people interested in forming a group in Oregon should send a SASE to Willy McBride, c/o 2529 SE 14th Ave., Portland, OR 97202. Include year and model. Free copies of parts breakdown with Saab part numbers available for V4s.

UPDATE TO TRAILER HITCH WIRING

I am submitting a supplement to the article I wrote you on the hookup for amber trailer lights for the Saab 900 (Sept. '85 newsletter). The design called for a relay with a capacity of one amp per lighting circuit. If the user decides he needs brighter lights, which most of the trailers are, then he must use the following relay instead of the one specified: Radio Shack P/N 275-247 SPDT Miniature PC Relay 12 VDC coil 3amp contacts \$2.99 each.

Kenneth Williams, Old Saybrook, CT

EDITORIAL TRANSITION CONTINUES

This issue comes to you through the collaboration of Tim Winker, the new editor and myself. We will work together again on the next issue and in January, Tim will be on his own!

Carolanne Curtis, Editor

MEMBERSHIP/SUBSCRIPTION

Dues for membership/subscription are as follows:

First year, third-class mail	\$14.00
First year, first-class	\$15.00
Renewal, third-class	\$11.00
Renewal, first-class	\$12.00

First-year membership includes two back-issue newsletters and Club emblem.

A collection of 20+ back issues is available for \$10.00

NEW 900's FOR 1986, cont'd. from p. 1

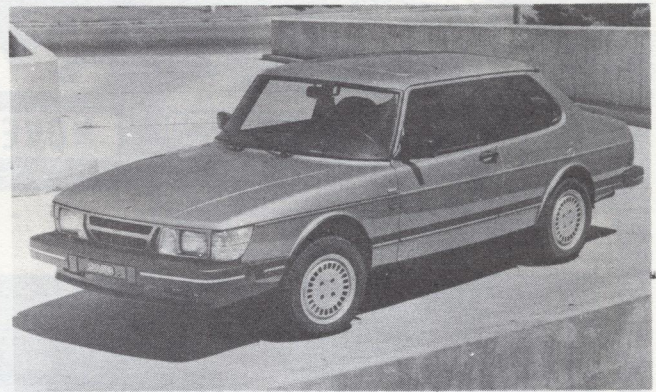

The Saab 900S gets a new 16-valve, naturally-aspirated (not turbocharged) engine for 1986.

For the more luxury-minded driver, the 900 Turbo can be specified with the Exclusive Appointments Group. This includes leather upholstery, fog lights, and an electrically-powered sunroof to replace the manual sliding sunroof that is standard on all Turbos.

For all-out performance, Saab offers a third version of the 900 Turbo: the limited-edition Special Performance Group. Reflecting the nature of this road-burner, the Turbo SPG comes in one color only (dark grey metallic) and with only the 5-speed manual transmission.

The SPG package includes aerodynamic lower body fairings, 3-spoke light alloy wheels, tires certified for sustained speeds of over 130 miles per hour, leather seats, fog lights and a power sunroof.

Saab 900 gets engine upgrade

The Saab 900 is powered by a fuel-injected overhead cam 2.0 liter engine, upgraded for 1986. A new fuel enrichment system contributes to better driveability when cold. The intake air preheating system of the 900 engine has also been modified. The engine warms up more quickly, which reduces wear and saves fuel.

For all its practicality, the Saab 900 comes with a high level of standard equipment. Air conditioning, central locking, heated front seats, and remote control outside mirrors are standard. Other features include low-pressure gas shock absorbers, halogen headlights, tach, map reading light, velour upholstery. The Saab 900 is available as a 3-door hatchback or a 4-door sedan.

All 1986 Saabs with manual transmission get a shift indicator light which helped improve fuel economy an average 9.11% in EPA tests.

The 1986 Saab 900 Turbo, 900S and 900 will be available October 1st, from 343 dealers nationwide.

Later in the model year, Saab-Scania of America will introduce a new, larger car, the Saab 9000, which spearheads the Swedish automaker's entry into the upper end of the European sports sedan class.

REPAIR/REBUILD/REPLACE A 99?

I would like to offer my view on the "repair/rebuild/replace—the-old-Saab" debate. My 1977 99GL 5-door spent its first three or four years in the Chicago area, accumulating an average number of rust holes, parking lot dents, and general wear and tear. Several more years in Southern California in salt air and strong sunlight contributed to the deterioration of the paint. Some unscheduled off-roading and a collision contributed to a considerable alignment problem. In early 1985 I looked at the dents, rust, oxidized paint and crooked alignment and decided it was time to do something about the situation.

As I saw it, I had three options. The first was to buy a new Saab, the second was to overhaul my present 99 and the third was to buy a new car of a different make. A trip to a local Saab dealer convinced me that both the 900 and 900 Turbo were out of my price league, regrettably ruling out my first option.

Next, I considered my third option; to buy a new car of a different make. I valued my 99 for its practicality, safety, and uniqueness, and decided that if I were to buy a new car the maximum I would spend was \$10,000. (I know the dollar figure severely limited my choices of new cars and that there are many used cars available for less than that amount, but I was very reluctant to buy a used car with potentially hidden problems.) Using practicality, safety, cost and uniqueness as my discriminators I attempted to identify a suitable car. It probably comes as no surprise that I could not find such a car.

Therefore, I was driven to my second option and I began to investigate the possibility of overhauling my 99. The list of jobs which needed to be performed included bodywork, paint job, alignment, check of motor and transmission integrity, and general repair and replacement of neglected systems of the car. I made an extensive list of work that I wanted performed and set out to collect estimates. After speaking to several body and mechanic shops I concluded that if I were to proceed with this avenue I would want a complete paint job (remove the doors,

trim, motor, and interior; repair all the dents and rust; change the paint color from brown to red), and engine overhaul, a transmission overhaul, and such additional work as was required to produce a car which I could reasonably expect to drive with a minimum of problems for at least another four years.

I collected several estimates locally from respected shops, was unpleasantly surprised to find the cost in excess of \$5000, and then called in Andrews Auto Rebuilding of Princeton, MN. They came to Seattle to evaluate my car and then returned to Princeton to work up the estimate. In the meantime I investigated insurance.

My concern about the insurance was whether I would be able to recover the cost of overhauling the car should I wreck it shortly after the work was performed. I found that many companies will write policies based on my dollar figure rather than that determined by the Blue Book, and that doing so would approximately double my premium (which was rather low). This was welcome news, and was a factor in my final decision.



When the AAR estimate arrived in the mail I was happy to find it substantially below the figures I collected in Seattle. This convinced me to keep the 99 and go ahead with a major overhaul.

I chose to personalize my car by the addition of an airdam, louvres, new tires and rims, and engine modifications, adding considerably to the cost of the project, but by no means exceeding the figure I had set for a new car.

Through the coordination and assistance of my father, the Andrews, and the bank I picked up my "new" car on Labor Day weekend. The thoroughness of the job, which really amounted to a restoration, was better than I had expected. The appearance and performance of the car was greatly enhanced. After having put approximately 2500 miles on the car I have concluded that the money was well spent: the motor is extremely strong, the transmission is quiet and smooth, the handling is greatly improved, and the car is a real head-turner.

If other members are considering a similar course and would like to ask me questions, they are welcome to call me at (206)-655-1983 from 8:00 to 5:00 PST.

R.H. Eric Goss, Seattle, WA

 *The Classic Swede* 

SAAB 95&96 PRESERVATIONISTS
FORMERLY OF ASHFIELD, MASS.

NEW ADDRESS
THE CLASSIC SWEDE
RDI BOX 209
MONTOURSVILLE, PA. 17754

ALL INQUIRIES INVITED

Y A T E S

*Because you are a SAAB owner,
you are special to us.*

*Because we are a SAAB dealer,
we strive to be special
for you.*

BOB YATES SAAB
Langhorne, PA 19047
215-752-3000

**A
A
B**

SAAB SERVICE TIPS

COLD ENGINE DRIVEAWAY, M84-85 900's

A service kit (P/N 88-18-015) is now available for improving the driveaway of the car immediately after starting from cold at ambient temperatures between 59 and 77 degrees F. See S.I. 07/85-769 (available from the Saab Club with SASE with \$.39 postage and \$2.00) for diagnostic steps to perform prior to determining the need for this kit. The kit is primarily intended for naturally aspirated models but will also fit the 1984 Turbo. It cannot be adapted to earlier 8 valve engines.

Installation of the service kit involves fitment of a new cold-start enrichment switch and rearranging the positions of the thermo-contact and thermo-time switch. Modification Details

1.) Drain the engine coolant to a level below the thermostat housing.

2.) Remove the thermo-time switch (Fig. B, Pos. 2) from the intake manifold and the thermo-contact from the thermostat housing (Fig. B, Pos. 1). Install the thermo-time switch in the spot vacated by the thermo-contact at the thermostat housing. Test the thermo-contact as described below. If OK, install at the intake manifold at the spot vacated by the thermo-time switch. If not, replace with a new thermo-contact (P/N 75-06-322 M84-85). Testing the Thermo-switch:

Test the temperature setting of the thermo-contact removed from the thermostat housing.

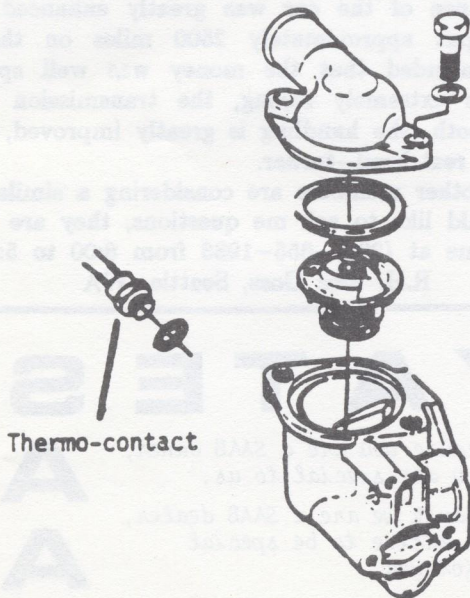

Figure A

Saab Service Tips -- September 1985

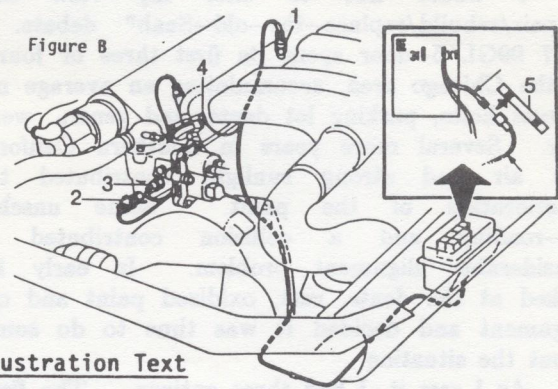

Illustration Text

Relay Holder
Red/Yellow wire connections

1. Thermo-contact	75-06-322
2. Thermo-time switch	83-61-362
3. New Cold-start enrichment switch	75-34-910
4. Ground connection	
5. Diode (delete)	85-30-966

The thermo-contact must be tested in a glass of water to meet the following specification. Thermo-contact: Closes at 66 +/- 6 degrees F.

Opens at 77 +/- 6 degrees F.

Mix warm and cold water to achieve a temperature of 66 +/- 6 degrees F. (Measure with a thermometer).

Connect a continuity tester to the terminals of the switch and submerge the switch in water. Allow the switch to stabilize with the water for at least one minute.

If the switch contacts do not close, replace the faulty unit with a new thermo-contact.

Re-fit the thermo-contact and gasket at the intake manifold.

3.) Rearrange the existing cable harness for the thermo-time switch and auxiliary air valve so that the original thermo-time switch connection at the intake manifold now goes to the relocated thermo-time switch at the front of the thermostat housing.

4.) Remove the blank plug from the thermostat housing and fit the new Cold-start enrichment switch with gasket supplied in the kit (75-34-910). Connect the cables from the original thermo-contact removed earlier to the new switch (Fig. B, Pos. 3).

5.) Pour the coolant back into the cooling system. Bleed and pressure test the cooling system.

6.) ~~Connect the new cable harness supplied in the kit (95-55-897) to the relocated thermo-contact in the intake manifold (Fig. B, Pos. 1).~~

continued next page...

The Club thanks Mr. Daniel L. David, Manager of Technical Services at Saab-Scania of America, and Mr. Robert J. Sinclair, President of Saab-Scania of America, for continuing to provide Saab Service Information bulletins.

SAAB SERVICE TIPS Continued

7.) Run the ground cable for the new cable harness under the intake manifold and connect it to the rear of the auxiliary air valve mounting bolt (Fig. B, Pos. 4).

8.) Run the new cable harness along the existing front cable harness to the Emission Relay Panel. Secure the cable harness in position, using the 4 clips supplied in the kit (Fig. B).

9.) Remove the Emission Relay Panel and the relay holders and run the new cable harness through the bottom rubber grommet.

10.) Remove and delete the diode (Fig. b, Pos. 5) and connect the yellow/red cable of the new cable harness. Do **not** connect the disconnected green cable. Isolate with electrical tape.

11.) Re-fit the relay holders and Emission Relay Panel.

12.) Start the vehicle and bring to full operating temperature. Check and, if necessary, adjust the pulse ratio of the Lambda system. The following values are recommended after fitting the service kit. Setting value: 45 - 55%.

REPAIRING INOPERATIVE DOOR LATCH

Saab S.I. 09/85-785: The opening mechanism may become inoperative due to the tie rod working loose from the mount for the hatch handle. This may occur from a tie rod bushing that is too narrow and is not secured in its mounting bracket.

Check the tie rod bushing and replace it if the groove in the bushing does not match the dimensions in the drawing (1.8mm + 0.2, -0.0mm). The bushing must be secured by the bracket.

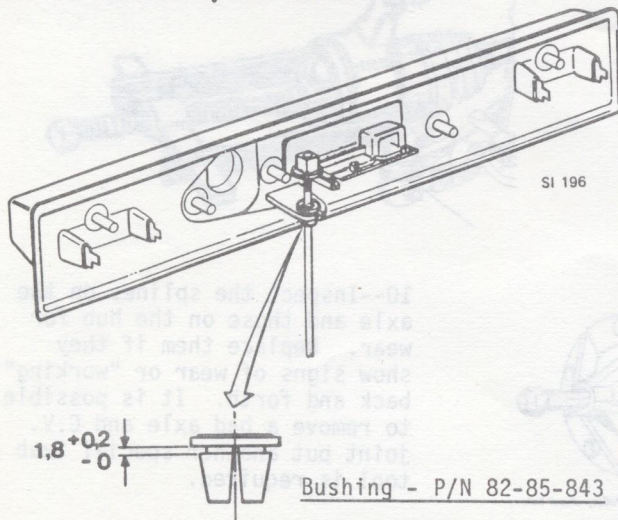

MORE SAAB SERVICE TIPS

Saab All-Season Antifreeze Coolant has recently been released by Saab. The coolant (phosphate-free) is exactly the same as the Factory fill and up until now phosphate-free coolants have

Continued next column...

been generally unavailable in the U.S.

The Saab brand coolant has excellent corrosion protection against damage to the radiator, cylinder head and other aluminum components. Phosphate-free coolants in general help prevent solder blooming in the radiator.

Saab warranty repairs require the use of Saab coolant of a coolant with the same specifications.

1.) Fuel tank overpressure should never be noticed on M83 1/2 and later, 900 models when the gas cap is released. These cars are equipped with a pressurized canister within the fuel tank and do not require tank pressurization. Should overpressure occur, check the fuel tank vent line for obstruction or kinks by applying pressure with a hand-held pump from the tank side.

2.) A new intercooler has been introduced into early 1986 900 Turbo production. The new intercooler is built with plastic tanks instead of aluminum. The core is still aluminum as with earlier versions.

3.) Do not use road-tar solvents to remove debris from plastic tail light, front cornering lights, reflectors, painted plastic surfaces or plastic mirror housings. These solvents attack plastic surfaces (most noticeably, plastic lenses) and can cause small cracks in a very short time. Instead use a paint prep solvent (Acry-Leen, Prep-Sol) to remove oil based debris. In any case, be sure to wash the surfaces with soap and water immediately after cleaning with solvents.

4.) Child safety seats sold by Saab (P/N 02-74-001) require a separate belt (P/N 02-74-027) when used in the center seat position. The separate belts bolts up using the existing center belt mounting bolts. The existing Saab center belt can be retained or removed depending on your preference.

SAAB SPORT & RALLY SELLOUT

I have received a list of Saab Sport and Rally parts currently on closeout which may be of interest to some of you. Most of these are for V4's, though there are a few items for 99's. Most prices have been drastically reduced in order to make these items affordable to V4 racers and rallyists. All items must be purchased from a Saab dealer, require a special Sport & Rally order form with the customer's signature, and quantities are limited. Orders will be handled on a first-come first-served basis and no back orders will be carried.

The list of these parts is available at your dealer, or I can furnish a copy with a SASE and \$1.00 for copying (it's 5 pages long).

Questions regarding application of these parts should be directed to the Sport & Rally Department, Saab-Scania of America, Inc., Saab Drive, P.O. Box 697, Orange, CT 06477.

Carolanne Curtis, Editor

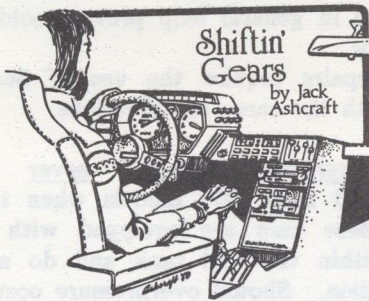

REPLACING A FRONT WHEEL BEARING--SAAB 95, 96 & 97

Installing a front wheel bearing isn't as tough as it might seem. You do have to have a few tools and then you can do the job with the axle in the car. Here's how its done:

1--Jack up the car and block it, remove the hubcap, then the spare tire and rim.

2--Bend the lock tabs out of the way on the 2 brake caliper securing bolts and remove the bolts (5/8" socket). Pull the brake caliper off the disc and hang it up with a piece of wire so it doesn't dangle on its own umbilical cord, the brake hose.

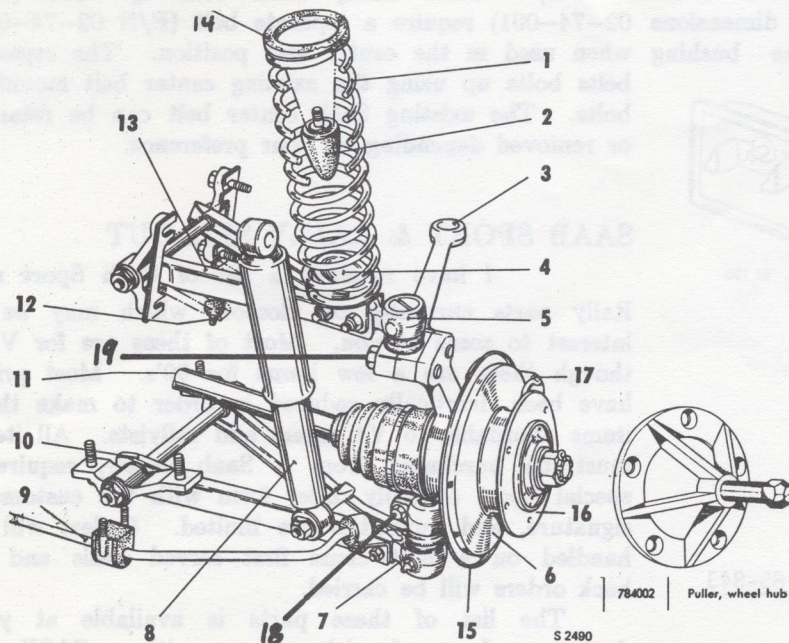

FRONT SUSPENSION, LEFT

- | | | |
|---------------------|-----------------------|-----------------------|
| 1. Coil spring | 7. Lower ball joint | 13. Upper control arm |
| 2. Rubber bumper | 8. Shock absorber | 14. Rubber spacer |
| 3. Steering arm | 9. Stabilizer bar | 15. Protective shield |
| 4. Spring support | 10. Lower control arm | 16. Hub |
| 5. Upper ball joint | 11. Inner drive shaft | 17. Brake housing |
| 6. Brake disc | 12. Rubber bumper | |

SAAB

Oct. 1989

3--Remove the cotter key on the big center nut of the axle and throw it away. Remove the big center nut on the axle (1 5/16" socket and an impact wrench are needed now and later, too).

4--Now you do need a special tool. Use the Saab brake drum remover tool No 784002 and pull the hub and brake rotor off the axle. **SEE BELOW...**

5--Remove the brake disc dust shield plate. (7/16" socket on some models, phillips screwdriver on the others).

6--Remove the retaining bolt on the LOWER ball joint (5/8" socket on one end, 11/16" socket on the other end). **#18, BELOW, LEFT...**

7--Bend back the tabs on the two bolts behind the tie rod steering link and below the upper ball joint. Do NOT remove the two bolts on the upper A-frame that secure the A-frame to the upper ball joint! (3/4" socket). **#19, BELOW, LEFT...**

8--Remove the clamp from the boot on the inner driver, next to the transaxle (screwdriver).

9--Use a sturdy gear puller and pull the hub off the axle. The axle stays in the car.

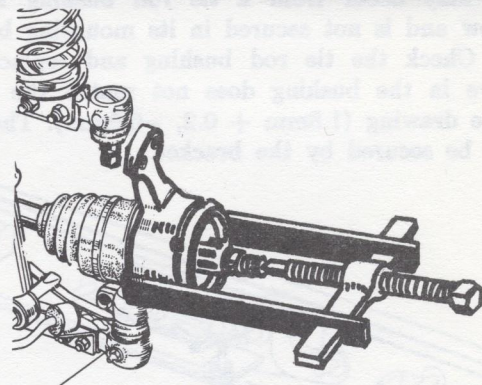

10--Inspect the splines on the axle and those on the hub for wear. Replace them if they show signs of wear or "working" back and forth. It is possible to remove a bad axle and C.V. joint but another special Saab tool is required.

11--Now take the hub you just pulled off over to your vise. Use a punch and a hammer and remove the big bearing nut and outer seal from the hub.

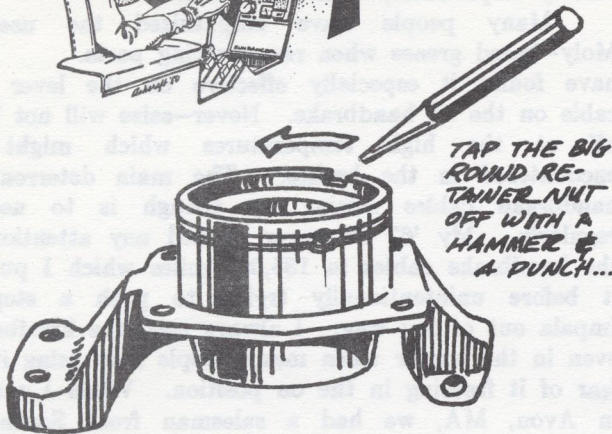
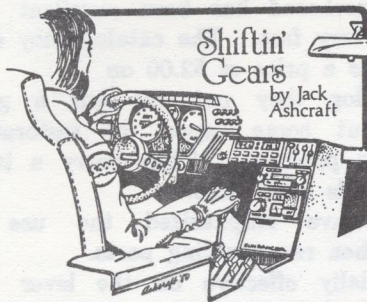

12--Turn the hub upside down and tap out the wheel bearing. In rare instances you may have to press it out with a press.

13--Now clean everything very thoroughly. Use heavy duty wheel bearing grease and grease the new wheel bearing thoroughly. Work from both sides of the bearing.

14--Change both seals.

Inner seal is Saab No 7312754
 Outer seal is Saab No 7093974
 Wheel Bearing is Saab No 7079262

15--Tap the new bearing into the hub. Be sure you only tap on the very outside of the bearing and never on the inner portion or the balls. It will help if you put just a light coat of engine oil on the outside of the bearing--it goes into place easier.

16--Replace the big round bearing retainer nut. Tap it home with a hammer and punch, then bend over the keeper ring of the nut into the recesses in the hub assembly to retain it.

17--Now go back over to the car and check the axle assembly at the inner driver. Make sure that there is grease in the slides for the bearing cups and that the bearing cups have grease in them and that the ends of the "T" where the bearing cups go are smooth and not worn and grooved. Line up the axle with the driver slides and ease them in place.

18--Place the hub assembly over the axle. Now you need a special tool made from a 1/2" thick piece of steel to draw the axle into the hub assembly a ways. Use the washer and

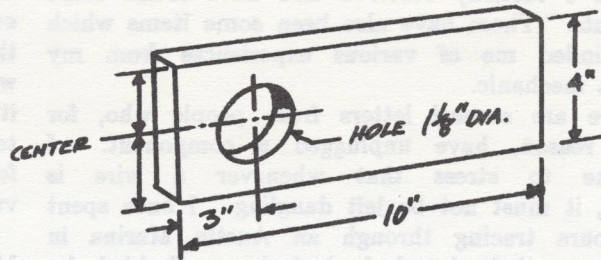

nut for the axle hub and run it up with the impact wrench. Take care not to let the nut bottom out against the splines.

19--Replace the disc brake splash shield.

20--Place the disc brake assembly back on the axle, after backing off the big nut and removing the special tool. Put the nut and washer on the axle after the disc brake assembly is on. Draw it into the proper in-out location on the axle. Check against the other side if you are unsure if you have it pulled down to the proper place or not.

21--Place the assembly onto the bottom ball joint stud. Check the inner driver at the transmission to make sure the axle "T" is into the slides as it is supposed to be.

22--Replace the 2 bolts you took out of the tie rod link just below the top ball joint. Be sure you put the tab plate back on the bolts. Tighten the bolts and bend over the retaining tabs.

23--Now put the single bolt back into the hub assembly at the bottom ball joint and tighten the bolt.

25--Put the brake caliper back on, making sure you don't misplace a brake pad. Be sure the lock plate is on the mounting bolts. When the bolts are tight, bend over the retaining tabs on the lock plate.

24--Thoroughly clean the brake disc with alcohol, taking off all the finger tracks and other collected grease from the operation.

26--Replace the tire and rim. Let the car down off the jack and/or blocks. Torque the center hub bolt to about 75 foot pounds, but bear in mind you must make the new cotter key line up in the hub. Install the new key and bend it over. Tighten the lug bolts on the rim. Put on the hub cap.

It all takes about an hour and a half once you get the hang of it. Be careful of the brakes the first couple of times you apply them after the job as they may not pull quite evenly at first, but should settle down after you use them a couple of times.

MISC. TIPS FROM ANDY PETERSON

I have been reading through some of the back newsletters I recently received and have found some helpful hints. There have also been some items which have reminded me of various experiences from my years as a mechanic.

There are several letters from people who, for whatever reason, have unplugged a component. I would like to stress that whenever a wire is unplugged, it must not be left dangling. I once spent several hours tracing through an Austin Marina in which the seatbelt interlock had been disabled by unplugging the sensor in the seat.

The wire was left to dangle on a sharp edge of the seat frame and eventually wore through the insulation. After opening the wiring harness back to the interlock relay under the dash, I found that the only wires burnt were the ones to the seat, but the potential had been there for a real disaster.

I have seen some very sloppy accessory installations with wires drooped everywhere. All additional wiring should follow the existing wiring harness wherever possible and preferable be run through its own wiring tubing. Shrink tubing can be purchased from any electric supply store. Mine came in several diameters and 4 foot lengths for under \$2.00 each. Cheap insurance against disaster. It can also be had in longer length although one can be slipped over another after the first is shrunken.

Use the proper size wire for the job.

I saw a new BMW 2800CS once which had a burglar alarm installed using bell wire. The fire which ensued the first time the car was left unattended with the alarm on cost the owner over \$3000 on a \$10,000 new car. Another experience was with a FiberFab kit car which had been wired with #10 and #12 wire throughout and had twisted, unslodere[, untaped splices every 3 feet.

My advice is if you do not know how to do a job, either get a book and learn slowly and carefully, or take the job to a competent professional before you butcher it. It costs more to have a job done over than it would have cost to have it done in the first because the mechanic has to undo the damage first.

For anyone who might be planning to do their own body work, I would recommend The Eastwood Company, P.O. Box 296, Malvern, PA 19355 for tools and body repair products. They advertise in "Car

Collector and Car Classics" which last month featured a mint Saab 93B owned by Saab Eastern Regional Service Manager Will South. The quality of everything I have purchased has been excellent and the service has been very fast. The catalog they sent with my last order has a price of \$2.00 on it.

Every catalog they put out has a good technical article about some aspect of restoration featuring one of their products. They carry a large variety of products, tools and books.

Many people have emphasized the use of Moly-based grease when reassembling parts.

I have found it especially effective on the lever and cable on the 96 handbrake. Never-seize will not burn off at the high temperatures which might be encountered in the brakes. The main deterrent to handbrake cables seizing up though is to use it regularly. My '67 96 never needed any attention to the handbrake cables in 135,000 miles which I put on it before unintentionally trying to push a stopped Impala out of my way. I always used the handbrake, even in the winter when many people stop using it for fear of it freezing in the on position. When I worked in Avon, MA, we had a salesman from Southwest Petroleum Products (SWEPCO) who sold us a penetrating oil which had Moly in it. The penetrating oil carries the Moly into a space and the Moly continues to lubricate after the light oil has dried out. This product, SWEPCO 808 sells for about \$8.00 a can. I find it to be a great lubricant for door hinges. Many shops use white grease which usually has the effect of staying on the outside of the hinge and collecting dirt. SWEPCO also makes other products with Moly in them (we used their gear oil, also).

In reference to the letter from Charles Maurer in July '84: the inner lights on the rear of the 900 are wired as fog tail lights in Europe. I do not know about Canada, but the reason this is not done on U.S. cars is probably more a question of Federal standards that Saab not wanting to provide this feature. For people with older cars, Hella makes a fog tail light which can be wired into the system with your fog lights. I don't know the number, but I have seen it in Acme Auto Supply Stores here Connecticut.

I would like to recommend Precision Automotive in Simsbury, CT for machine work. Their attention to details costs a bit more but will be worth it in the long run. They do a tremendous amount of racing work. My own experience as a mechanic working for various people over the years as shown me that people who work on race cars generally (though not always) do better work because they are more thorough.

Although I have a harder time explaining things to people who do not understand their cars, I have never minded trying to teach anyone the proper way to do a job. I sure hate having to come in behind someone who didn't know that they were in over their head until too late, though. Sometimes this is

MISC. TIPS continued on page 10

SWEDISH ADVANCED AUTO BAY

INDEPENDENT SAAB REPAIR
PARTS & SERVICE

N.I.A.S.E. CERTIFIED

FACTORY TRAINED

LEWIS NORRIS
Master Technician

15616 INGLEWOOD AVE.
LAWNDALE, CA 90260

1/2 Block So. 405 Fwy.
(213) 536-0161

PARTS MART

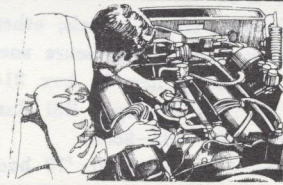

CLASSIFIED AD RATES

Ads offering parts or Saabs for sale or wanted at prices under \$200 are FREE to members and non-members, 25-word limit, plus name and address. Ads listing prices of \$201 to \$900, enclose \$2. Ads listing prices \$901 to \$2000, enclose \$5. \$2001 and up, enclose \$10. All ads without a price listed, enclose \$10.

Commercial ads: contact Editor for rates and info. We will delete all unnecessary superlatives and abbreviate where possible. Please enclose sufficient funds with ad copy; we will *not* bill.

Classified Ad Deadline

The Classified Ad deadline for the December issue will be November 13. The deadline for the January issue will be December 18. Note: the deadline for commercial ads is 1 week before the classified ad deadline.

Sonett's for Sale

1967 Sonett, 2-stroke, #189, oil inj., triple carbs., 2 elect. fuel pumps, am/fm cass., Metalers, '78 mags, 2000 mi. on eng., very cln. Allen Shapiro, 1301 Trenton Dr., Anaheim, CA 92802, 714-632-0420 days, 635-5748 eve.

1974 Sonett III, 35K mi., very orig., no rust, stored winters, 2nd owner: \$35000, Steve Anderson, 515-255-2433 evs.

1974 Sonett III, Imron orange, no rust 88K, new clutch, welded f/w, valve job, seals etc, dealer's service & parts catalogs, Konis, nice int.: \$3200 obo. Sonett II serv. man. copy: \$25. Leonard Butters, E. 206 64th Ave., Spokane, WA 99223, 509-448-9688.

95's and 96's For Sale

1958 93B, exc. orig. running cond., 70K mi., complete never repainted, new upholst avail. to create concours car: \$3500 obo. Parrformance, Litiz, PA, 717-627-SAAB.

1961 GT 750, restored, new b rakes and gas lines, '66 sport disc brakes on fr., new paint, cashmere white, GT seats, wood steering wheel, Halda speed pilot, 850 fact. rebilt. oil mix eng, Michelins: \$875. 1965 Monte Carlo, no eng. or trans.: \$65. V4 blue eng. runs well \$90. V4 black eng. 1972, 68K mi., new b.s. gear, reads reworked, unassembled incl. eng. rebld. stand: \$325. F. V. Gunderson, R.D. 2, Boonton, N.J. 07005, 201-334-7783.

1969 96 V4, 8M mi. on rebilt eng, good trans., virt. rust-free OA car: \$700. Scott Johnson, 602 2nd Ave SW, Austin, MN 55912, 507-433-4188 after 6pm CST.

1970 95, drives well, eng. and trans. in good shape, body has some dents: \$750. George Dieter, 1705 Roswell Rd. #14, Marietta, GA 30062, 404-977-2498.

1971 95, exc. cond., recent repaint, no rust, 79K mi., orig. owner, int. cln.: \$1500 neg. Timothy Smith, 4342 Reno Rd, N.W., Washington, DC 20008, 202-537-1517.

95's & 96's for Sale, cont'd.

Late 60's 96, V4, runs good but no reverse; parts car, extra trans axle, 3 extra V4 engines, 2 transaxles for 2-stroke, many other parts: \$500 for all. Tom Denton, PO Box 393, Geneva, FL 32732, 305-349-5271.

95, 96, and Sonett Parts for Sale

1974 Sonett III, parting out all except eng., trans., rear glass, & wheels, have fr. clip w/buckets, rear clip doors, seats, gauges, & more; send SASE for list of parts, prices & terms. Patrick Bolmeyer, 1407 Oak Hill Rd, Wilmington, DE 19805, 302-994-6357.

Sonett III Parts, exc. fr. fiberglass \$1000 incl. ship, \$850 you pick up; rear fiberglass \$450/\$356; doors \$125, III window \$100; used Fomoco \$25; distributor \$35; callpers \$35 ea. Mike Tucker, 2324 Davis Dr, Matthews, NC 28105, 704-846-4098.

A/C from 1973 96, \$120 complete; 2-stroke 3 sp. trans. exc. cond.

\$100; 4 '66. Sonett r&p \$100. Hybert Adams, McIntire, IA, 515-737-2235 evs.

95, 96 & Sonett Wanted

Wanted: air cleaner for Sonett V4 \$15; streamlined outside mirrors \$30 pr.; metric speedo \$10. Have parts to trade. Bill Strangfeld, 233 Burns, Cincinnati, OH 45215, 513-948-1071.

99's and 900's For Sale

1975 99LE, redone thruout mech. and int., a/c/ sunroof, am/fm cass., mags, 4 sp.: \$2500, John Linn, 214-578-1772, Dallas, TX.

1976 99GL, 4 dr., 4 sp., 114K mi., cruise, am/fm, v. gd rubber: Asking \$2695. Bill Mein, Potsdam, NY, 315-265-4867 evs.

1978 99 Turbo, beaut. cond, eng. & trans. overhauled, new MXL in Incas, KYBs, brakes, met. gray paint, best offer near \$5000. Will deliver, Dennis Sweeney, 207 E. Church St., Ligonier, PA 15658, 412-238-4556.

99 & 900 Parts for Sale

1 set of 4 drs., good to very good cond \$125 per, always stripping 99's, no lenses or grills. Service Above & Beyond, 1512 Throop, Chicago, IL 60622.

Parting out 1978 EMS, 25K mi, eng. \$400, trans. \$350, both \$650, many other parts; 1974 wagonback pass. door w/glass white \$75, taillights w/housings \$40 ea, gold seats \$40 ea, trim; 1974 Sonett II pass door, no skin, good glass, trim \$100, hood \$60, some trim. Dennis Minni, Box 36692 Strongsville, OH 44136, 216-238-0365.

'79 900 motor block, 59K mi., incl. crank & pistons, filter adaptor, flywheel, camshaft & cradle; also avail. exh. manifold, intake manifold, & throttle housing. \$450 obo will part; comp. cat. exh. sys/ no leaks \$100 obo; '78 99 Turbo trans. for parts free. James Burt 319-332-4065 5pm-9pm CST.

Want ads continued on next page

99 & 900 Parts For Sale

1971 99 parts car, no eng., trans., wheels; otherwise complete. Good body & int. \$150 u-haul; F.I pressure sensor mounts on wheel well for '73/'74 99 brand new in box \$145 + Ship; 99 fact. serv. man. thru '74 \$35 + ship. Bill Randle, 2369 NW Torsway, Bend, OR 97701, 503-382-9385.

1972 99E eng. & trans. 80K mi. \$100, '70 hood \$50. All + ship. Gary Greiner, 501 N 22 Ave W, Duluth, MN 55806, 218-727-7042.

Tires good cond. 185/65 R 15 P8 35K mi., \$25 ea. + ship. Bob Stirtz, 312-623-0656.

Complete '79 900T 5 dr for parts many 99 parts also. Dennis Sweeney, 207 E. Church St., Ligonier, PA 15658, 412-238-4556.

99 and 900 Parts Wanted

Wanted: glove compartment with hinge and lock ass'y for '74 99. R. Binks, Box 404, Helotes, TX 78023, 512-695-8859.

Wanted: alloy wheels (5.5/6.0" wide) set of four with lug nuts to fit '79 900 GLi. Jacques Roeth, 3118 Cole Hill Rd., Berne, NY 12023, 518-797-3075.

ANOTHER 99 CLUTCH PEDAL FIX

Here is a fix I used on a clutch pedal on a '78 99. As you probably know, the hole for the pin has a tendency to become "wallowed out" after a few years, and I have seen several fixes described in the newsletter. Mine was simply a variation - I drilled out the hole and used a short section of a valve guide. The hole in the guide fits the pin exactly, and I used JB WELD to cement the guide in place (not that it can really shift out of position once the pedal is re-installed).

Lynn Warren, Bellevue, WA

MISC. TIPS, cont'd.

necessary with supposedly professional mechanics. I have always been able to learn a new job by following the book, but the last mechanics job I had the boss seemed to think that everyone knows and has done every possible job on every kind of car. He would actually yell at us for looking up the proper procedures!

Andy Peterson, Granby, CT

SOURCE FOR 95/96 CLUTCH REFACING

SCNA member Ted Silvey reports that Warheim-Air Brakes, Inc., 4513 Baltimore Ave, Bladensburg, MD is an excellent source for refaced clutch discs for 95s and 96s.

From Smoke Signals, SCNA Newsletter

BRAKE DRAG CAUSED BY ROAD SALT

In the parts of the country with heavy snowfall, cheap salt, and over-optimistic drivers, Saabs are prone to problems with dragging brakes. Salt corrosion and accumulated crud hangs up the brake yoke and its grooves, preventing the outer pad from releasing. This happens more on the left than the right front wheel, and only rarely on the rear wheels. In addition to wasting fuel to overcome the brake drag, the problem causes rapid outer pad wear, and overheating, scoring, and accelerated rusting of the rotor. These are fairly expensive problems to correct in advanced stages. At the start, though, it is an interesting afternoon's project.

BRAKE DRAG continued on page 11

ATTENTION

"Maintain The Performance"
Use Genuine Saab Parts and Accessories



DIAL THIS NUMBER COLLECT

414-771-2340

FIND OUT WHO WE ARE AND WHAT YOU HAVE BEEN MISSING!!

- "TRUE" LIST PRICES
- HEALTHY CLUB AND TRADE DISCOUNTS (15-35%)
- SUPERSONIC SERVICE

(You Owe It To Yourself And Your SAAB To Check Us Out!)

GISLAVED FROST	\$99.00
<small>(175/70 SR15 On 5 1/2" 900 Steel Rim)</small>	
BLOCK HEATERS	\$23.50
<small>(New Style)</small>	
SKI GOGGLES	\$45.00
<small>(With SAAB Logo)</small>	
BRAKE PADS	\$15.00



BURAGO 1/43rd scale SAAB 900 TURBO
"CLARION" Rallye Car
List price - \$3.95
SPECIAL - \$1.95, plus \$1.50 shipping per order

BUMPER STICKERS
186,000 miles per second.
It makes sense: It's the law. or (No 55)

Printed on vinyl. Easy to apply, easy to remove.
\$1.50 each, 2 or more \$1.25 each, any combination.
(10% of price goes to Citizens Coalition for Rational Traffic Laws, Dane, WI.)

SAAB/VOLVO CATALOG AVAILABLE IN EARLY 1986, \$3.00
Svenskonnekshun
5401 Avondale St.
Duluth, MN 55804
(218) 525-3904

SAAB VOLVO

FREW ENTERPRISES INC.

Swedish
Automotive Specialists
Since 1974 - The Only Alternative

727 First Avenue
Des Plaines, Illinois 60016 (312) 299-7153

BRAKE DRAG, cont'd.

Because drag comes on so gradually, I have formed the habit of letting the car drift the last few feet to a stop, foot off the brake, once a week or so. The final stop must be imperceptible and with no tendency toward backward lurch or suddenness. In addition, steering is a bit heavier when brakes are dragging. If things have gotten bad, you will smell hot metal after a run.

To inspect, jack up and remove a wheel. Might as well start with the left front. The hub and rotor should turn easily and the inner and outer pads should be worn equally.

To repair, see that the car is solidly supported. Rotate the disc until one of the cutouts in the edge lines up with the pads, using a piece of wood to pry between the wheel lugs if necessary. Before that, though, hammer off the loose rust around the cutout. Blow out or wire brush the 2 yoke grooves (see drawing) and slop in penetrating oil.

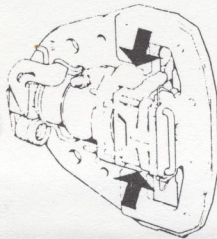

Also, oil the U-shaped pad retaining pin where it passes through the cylinder body. Note the position of the damper spring because it will fly when you pull the pin. Pull the safety clip from the inner end of the lower arm of the retaining pin and pry out the pin. To extract balky pins and brake pads, clamp on a vise-grip wrench and hammer on the knuckle pivot of the moving jaw, in the direction you want things to move. Loosen the outer pad by squeezing the protruding edge toward the rotor and the yoke with

the vise-grip. Extract the outer pad by prying or with vise-grip and hammer. With a heavy hammer, belt the yoke in a bit, which will help release the inner pad. Pinch it sideways if it is tight and extract as above.

Clean out the pad pockets with a small brush and slop more penetrating oil in the yoke grooves, but keep the oil off the direct piston's rubber dust shield. If the pads are worn enough to replace, rotate the direct piston (it presses on the inner pad) clockwise, using the special tool from Saab or a homemade approximation. This retracts the piston to clear the new pads and causes the brake fluid to rise in the reservoir. Two or three revolutions of the piston should do it. This rotation also helps free the brakes up a little. (A mechanic through the dust shield with a syringe before rotating the piston. He says it works great.)

Slip a really worn out brake pad into the inner pad pocket to stop the piston from popping out of the cylinder. With a long bar-like tire iron, pry the yoke out as far as it will go, prying against the rotor. Remove the inner pad and pry the piston back into its cylinder just until it is flush with the cylinder face. (If you get athletic and pry the piston all the way, you damage the piston seals, start a leak, and get to pay for a brake rebuild. In fact, a proper mechanic will want to rebuild both front brakes, thus doubling your expense.) Pry the yoke and piston back and forth until they move easily.

If you are installing new pads, grind about a sixteenth of an inch off the upper and lower edges of the steel backing to ease removal the next time. (Upper and lower as the pads will be when installed.) If one pad of a set has a V-groove in the rear edge, that is the outer pad. Install the inner pad first, then pry the yoke out for the outer pad. Grease the ends of the pad retaining pin sparingly, hold the damper spring in position and slide the pin home. Replace the locking clip. Apply the brakes several times -- until you have full pedal -- before starting the engine.

Piston Replacing Tool

Cut a piece of 1/8" thick sheet metal or aluminum about 7" long by 3/4" wide. Round off the corners and edges. Select a machine screw that will fit the pockets in the face of the direct piston -- about 1/8".

Drill and tap an undersize hole in one end of the metal strip and force-screw the machine screw through to protrude about 1/4". Cut the head off flush. Fit the stub into one piston face pocket and file a tang or equivalent into another. Press in with the file and pry against it with the homemade tool to rotate the piston. A better machinist than I could figure out how to position a second screw in the tool for a fulcrum, but he'd still have to press the piston in with something while turning.

G. T. Wilcox, Mentor, OH

SAAB OEM PARTS/ ACCESSORIES

- * 900 EUROPEAN HEADLIGHT
W/FILAMENT & COVER - \$110 ea.
- * FACTORY REBUILT SPEEDOMETERS
- * CONTINENTAL TS-730 165/SR15
MUD & SNOW TIRES
FIT 99 & 900 - \$41.95 ea.

- Guaranteed Low Prices • Same Day U.P.S.
- Wholesale & Retail

THE SWEDISH SOLUTION

27999 Miles Rd.
Chagrin Falls, Ohio 44022

(216) 248-1022 (IN Ohio)

1-800-556-PART

Please use knife/letter opener

Westwood CA 96137
Box 1174
Ron Lunder
86-01 F

NOV. 1985

FIRST CLASS

RETURN POSTAGE GUARANTEED

60 Charles Street
So. Meriden, CT 06450

FIRST-CLASS MAIL
U.S. POSTAGE
PAID
PERMIT NO. 1909



SAAB



VICTOR

Exclusively since 1958

SALES - SERVICE - PARTS & ACCESSORIES

Wholesale & Retail - UPS Daily Shipments

1125-35 Easton Road, Abington, PA (215) 886-8660

CLUB ITEMS AVAILABLE

- Club Patches--embroidered three-colored patches, 2-3/4"Hx4-1/4"W-----\$3.00 postpaid
- First Million Book--Saab-Scania published book by Gunnar Sjogren with Saab history and drawings Soft cover only-----\$3.00 postpaid
- 1976 Posters--16x20 poster with Mark Stehrenberger drawings of 92, 96, Sonett II, Sonett III and 99 EMS-----\$3.00 plus \$1.50 UPS
- Chambersburg '85 Posters--16x20 poster, yellow and black with a 900 autocrossing--\$3.00 plus 1.50 UPS
- Go Yump a Well-Built Swede T-Shirts are back in stock and feature a 99 rallying. -----\$7.00 plus \$1.50 UPS Specify S, M, L, or XL.
- Saab Club T-Shirts with the grill design from last year's convention logo, yellow with blue ink. Specify S, M, L, or XL. Orders will be delivered by early Nov.-----\$6.00 plus \$1.50 UPS.
- Brass Grill Badges --1-3/4x3" brass cloissone badge of Club emblem-----\$5.00 postpaid.
- Haynes Manuals-- for V4s, 99s and 900s are available for \$11.00 Third Class Mail or \$12.00 UPS. Please state model.
- Club Hats and Mugs are out of stock. We will announce when they are available again.

Please Note: Shipping costs are per order; i.e. two posters, UPS is only \$1.50. Send all orders to: The Saab Club, 60 Charles St. S. Meriden, CT 06450