

THE SAAB CLUB

SEPTEMBER 1984, NEWSLETTER #130

NEW ENGLAND SONETT CLUB--The next meeting of the New England Sonett Club is scheduled for 11 am on Sunday, October 7, 1984. The club will meet for a picnic in the Hemmings Publishing Company area in back of their parking lot in Bennington, Vermont. Hemmings is located 3.5 miles west of the intersection of routes 7 and 9 from downtown Bennington, on route 9.

Karen Hanson, Production Coordinator of Hemmings Motor News and a New England Sonett Club member has handled the meeting arrangements. This meeting will be held rain or shine as indoor facilities are available.

Members are advise to bring a picnic lunch and a blanket. A scenic drive is planned after the picnic. Due to heavy traffic during the foliage season and Columbus Day holiday weekend, additional driving time to the meeting should be allowed.

MILWAUKEE SAAB CLUB-- has rescheduled the September tech' clinic. The clinic will now be held Saturday, Sept. 22, at 9:00 am in Jim Hart's garage, 7125 N. Longacre Rd, Fox Point. The clutch assemblies in a 1980 and a 1974 99 will be replaced.

The 4th Annual MSC Kettle Kapers gimmick rally will be held Sunday, Oct. 14. Registration: 9:00-11:00 am. Driver's meeting: 11:00 am. First car out: 11:30 am. Come early and learn how to read a stick map or pre-register and receive entry materials in advance.

SE Wis. Saabers: Don't miss an event because of late schedule changes. Join MSC (\$6.00 per year) and receive a monthly mini-newsletter, parts discounts, specialty tools on loan and much more. For info on rally starting point and advance registration, tech' clinic or MSC membership, call Pat Greer, 414-964-7463.

CENTRAL ILLIANA SAAB CLUB--will meet Sept. 23rd instead of the 16th. Randy Riggs will do a session on "All about Clutches" at Margrit Adler's house, 1507 W. University, Champaign (217-356-9244);



Saab-Scania of America President Robert J. Sinclair discusses an Italian Laverda motorcycle with Erik Carlsson and John Kilroy of Milwaukee. (photo by Jeff Delahorne)

300 ATTEND SUCCESSFUL NATIONAL MEET

by Jeff Delahorne

The Swiss village of New Glarus, WI saw a Swedish invasion the weekend of August 18-19 as about 300 Saab enthusiasts gathered for the National Saab Club Convention.

Members drove from as far as California, New York, Connecticut, Florida, Louisiana, and Canada to name just a few. In attendance from Saab were President Robert J. Sinclair, Public Relations Manager Len Lonnegren, Central Region's Arsey Miller, and of course Erik Carlsson, the famous rally driver who put Saab on the map in the '60's.

The weather was sunny and warm which caused some discomfort in the un-air conditioned meeting room at the Wilhelm Tell Club, but some of the tech' sessions were held outside in the nice weather to compensate. Erik Carlsson showed slides from his run in the 1969 Baja 1000, along with interesting anecdotes, some of which cannot be repeated in print. Carlsson also managed to lose several cars following him in the rally, des-

Continued on page three

Saab Clubs of North America
Editor and publisher: Jeff Delahorne, 5805 Oneida St., Duluth, MN 55804
(218) 525-3253 9 a.m.-8 p.m. except Sunday
Consultants: Dick Grossman, Jack Ashcraft, Carolanne Curtis, Andy Buc, Ted Tucker

TWIN-TIER SAAB CLUB AT WATKINS GLEN--The first official outing of the Twin Tier Saab Club (Western New York) will be Sept. 29 -30 at the Watkins Glen race track. A hospitality area inside the track has been reserved for Saab enthusiasts during the IMSA Camel GT 500 race. Saab will try to have a 16-valve Turbo on display. For more info, contact Alex Barbier, 607-565-2711 home, 751-3458 work.

WESTERN PENN. AREA SAAB CLUB--organizing meeting. Plans are being made for a meeting the first week of November. Watch next month's Newsletter for further details. If you are interested, contact Bob Panella, 412-337-6118 after 6 pm.

ONTARIO SAAB OWNERS' ADV. DRIVING SCHOOL

Ontario Saab owners are invited to join us for the Fourth Annual Saab Owners' Club Advanced Driving School at Shannonville Motorsport Park (near Belleville) Sunday October 21, 8 am. The cost is \$60 for members and \$70 for non-members, with a \$10 deposit reserving a place. For event and club info, call Derek Hanson, 416-294-4063 or Dan Willison, 416-222-8066.

APPALACHIA SAAB CLUB-- will be meeting the third Tuesday of each month at Pennington's Fund Raising Co., 214 Market St., Johnson City, TN. Anyone interested in Saabs is welcome. For more info, call Mike Woods, 615-753-2101 or write Rt. 6 Box 349, Jonesborough, TN 37659.

SAAB CLUB NATIONAL CAPITAL AREA--is now meeting on the third Tuesday of each month, still at the Silver Spring Public Library. Outdoor session begins at 7:30 with the formal, indoor meeting at 8 pm. For more info, contact Toby Turpin, 301-384-6732.

SONETT CLUB OF SOUTHERN CALIFORNIA-- meets the second Thursday of each month at Antique & Classic, 18315 Mt. Baldy Cir., Fountain Valley, CA. For more info: SSCSC, PO Box 665, Sierra Madre, CA 91024.

SAAB CLUB OF SOUTHERN CALIFORNIA-- meets the third Tuesday of each month at the same location as the Sonett Club. Parking lot meeting at 7 pm, indoors at 8. For more info, contact Paul Florance, 54-62nd Pl, Belmont Shore, CA 90803.

MEMBERSHIP/SUBSCRIPTION

Dues for membership/subscription are as follows:

First year, third-class mail	\$11.00
First year, first-class	\$12.00
Renewal, third-class	\$ 8.00
Renewal, first-class	\$ 9.00

First-year membership includes two back-issue newsletters, Club tech sheets and emblem. Renewal notification will be stamped on the open rectangle at the top of this page. A treasurer's report will be made three times a year. This is a nonprofit organization.

A collection of 15+ back issues with Club tech sheets punched for your 3-ring binder is available for \$8.00 postpaid. Individual back issues: 75¢ each.

Always specify: 96, 97, or 99/900 for appropriate tech sheets.

YELLOW vs. WHITE FOG LIGHTS--ANOTHER VIEW

Are yellow fog lights better than white? Under certain conditions, yes; but not always. Charles Maurer offered some interesting opinions in his article in the August, 1984 Saab Club Newsletter (p. 3), but he missed some of the facts.

The purpose of a fog lamp is to light up the ground in front of the car, under the layer of fog. A white light allows the yet to see and define objects in colors that are familiar. But when there is snow on the road and in the ditches, the white on white is difficult to define, and yellow has the advantage, much like using yellow ski goggles to avoid a "snow-blind" condition.

According to Mitch Williams, a factory-trained lighting technician for Cibie and Marchal, yellow fog lenses cut the projected light by 5 to 10 percent, a figure he considers insignificant. This assumes you are using a good quality fog lamp with a high reflective range, and not the cheap \$5 discount store items. Though all 55-watt fogs can claim the same candlepower output, the quality of the lens and reflector makes a major difference in the projected light. Mitch Williams says that yellow is easier on the eyes if you normally use your fog lamps for several hours at a time. His recommendation is for yellow fogs in the snow belt, but stick to white if you live elsewhere.

Another good way to see in heavy fog or driving snow is to have your left and right side lights, including headlights, wired to separate switches. Eliminating the light on the driver's side of the car also eliminates much of the glare. This is particularly helpful if you run a lot of night rallies where fog or dust could make a difference in your leg times.

Having broken several expensive lenses on rallies and on the highway, I use and recommend protective covers. Yes, there are some disadvantages to screens and plastic covers, but with quality lamps, the light difference is insignificant. The cost is also insignificant when compared to the expense of replacing a lead-crystal lens assembly. Just look at the front of your car to see how many rocks have been repelled over the years. Look also at the lower valence, because fog lights should be installed low to be most effective.

When cleaning your lights, and you should clean them often for proper visibility, never use a handful of melted snow. The heat of a halogen bulb is much greater than that of a regular sealed beam, and the temperature differential can cause the lens to crack. Instead, carry a squirt bottle of windshield washer solution in the interior of the car where it can stay warm.

Tim Winker, Catalog Manager
Archer Racing, Duluth, MN

hakkapeliitta

Available in limited quantities, the Hakkapeliitta NR-09 snow tire can make your 95, 96, 97, 99 or 900 perform at it's best in winter slush, ice, snow and rain. The 185/65-15 is especially effective on 900 Turbo equipped with P-6's. Call now to be sure you'll have high-quality Finish-made Hakka's.

165-15--\$68 each incl. UPS

185/65-15--\$89 each incl. UPS

TAMARACK RALLYSPORT, Jeff Delahorne, 218-525-3253, 5805 Oneida St., Duluth, MN 55804.

NATIONAL CONVENTION, cont'd from page 1
 pite driving what he described as "the slowest Turbo I've ever seen." (This no doubt made those pursuing him feel even better.)

President Sinclair and two Saab service experts, Red Rambo and Harold Ruth, answered questions on a variety of topics in two different open panel sessions. The audience asked some varied, and at times, pointed questions, but all were impressed by officials' willingness to open up. Surely GM, Ford, et. al. top brass are not so easily accessible.

The rally on Saturday afternoon wound through the beautiful Wisconsin countryside, and was won by Bob Swinehart of St. Paul, MN and Jim Babcock of Marine-On-St. Croix, MN. With only one long, 40-mile leg, rallymaster Ian Simpson devised seven questions that could be answered with observations along the route and these served as tie breakers. Swinehart and Babcock's perfect score of zero was closely followed by Judy and Harry Argetsinger of Stanchfield, MN and Bruce Alexander and Lucky Kettles of Duluth, MN.

The tech's sessions were all well attended and quite informative, ranging from the very basic to very technical. There were more tech' sessions than last year, with two at a time going on Sunday morning.

The convention questionnaires that we handed out will give us a better idea of how to develop next year's event. We would like to move the convention further east next year, to the Eastern Ohio, Western Pennsylvania/New York area. This was felt by most to be a good compromise which will allow more members from the East Coast to attend, will not be an unreasonable distance from the Midwest. Denver was also suggested, but unfortunately it is a long ways from everywhere, except Colorado. So we welcome your suggestions regarding locale. We did get a good offer for next year from Carleton College in Northfield, MN, and though this is not the area we are looking at, perhaps utilizing the facilities of a small college is a good idea. Let us know.

My thanks to Mark Lundquist, who really did most of the planning and arrangements, along with Andy Federowski and Ian Simpson. I would also like to thank others who helped at Registration and the dinner, including Margrit Adler, David and Laura Sakata, F.A. and Ora Delahorne, Donna Delahorne, and others.



Part of the crowd assembled in front of the Wilhelm Tell Club for the Rally Tech' Session on Saturday, including the editor (center). (photos by F.A. Delahorne)

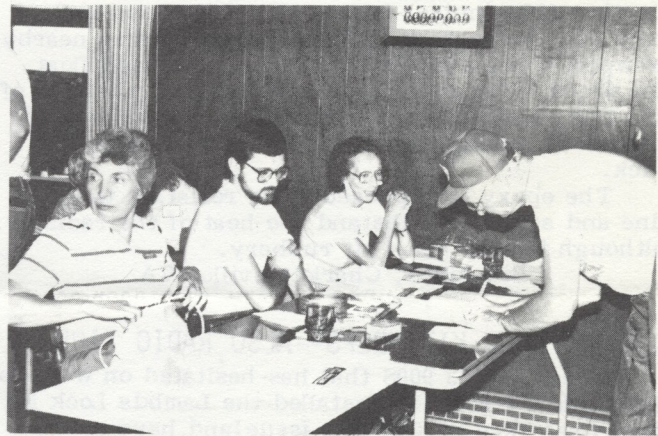

Ohio member Del Balunek registers with help from (left to right) Ora Delahorne, Andy Federowski, and Margrit Adler.

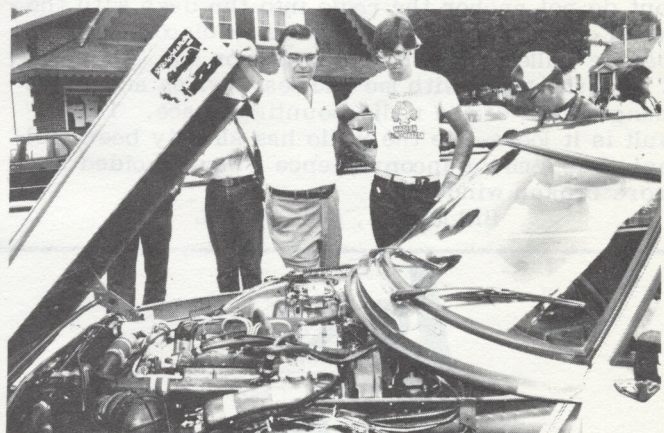

Saab-Scania of America President Robert Sinclair and Peter Simcik of East Hartford, CT inspect the engine of Erik Zenz's 99 Turbo rally car. (above)

At left, Saab's inundating the Swiss village of New Glarus, which according to Erik Carlsson, is "more Swiss than Switzerland."

5-MINUTE EPOXY CURES MISC. V-4 PROBLEMS

I have used "5-minute" epoxy as a temporary repair tool with success in two instances, and it is now a standard "tool" in my traveling repair kit.

The first time the small metal overflow tube on our '73 96 radiator cracked at its connection to the radiator body. It is a soldered joint from the factory, but being too lazy to drain the radiator, not to mention not having the right tools to do a new solder job, I used the epoxy, and it is still holding after six months. I will solder it sometime....

The second time was touring along to a beach vacation when our '69 96 began to flood out and finally stalled. I took the carb (Fomoco) cover off to find a minute tear along the edge of a soldered hole at the top of the brass float. The float was full of gas, causing it to sink, thus leaving the needle valve open. I enlarged the almost invisible hole and shook out the accumulated gasoline. The epoxy would rise into a bubble as the remnants of gas kept evaporating, but I kept working it back down and it finally set. In a hurry to beat the tow truck that the state police had called, we gave it very little set up time (10 minutes) before we reassembled and took off. We made it to Performance Cars in nearby Newport News where we bought a good used float for \$5.00. The epoxy may have held for the rest of the trip, but since the instructions called for a 12 hour total curing time, I didn't want to press my luck.

The epoxy is supposed to be resistant to gasoline and seems to withstand the heat of the radiator, although it does get a bit rubbery.

Bill Jobes, Charlottesville, VA

LAMBDA LOCK KIT HELPS--ALSO RADIO TIPS

I have an '83 900S that has hesitated on warmup from cold. I recently installed the Lambda Lock Kit from Saab (see p. 5 of this issue) and have noticed a slight improvement. It hasn't been cool since so I don't have a true test under the worst conditions.

I've had two break-ins of thieves stealing my radio. As a remedy which will hopefully deter any more trouble, I use the Saab installation bracket but do not anchor the radio into the dash with the small clips. The radio has a quick disconnect and can be pulled out in five seconds or so. This way I take the radio with me and leave wires and plugs hanging out of the radio mounting space. The result is it looks like the radio has already been stolen! For a minor inconvenience I have avoided any more broken windows.

Bill Morris, Chicago, IL



ROUTE 1, BOX 19D
RUCKERSVILLE, VA. 22968

SAAB PARTS & SERVICE
New & Used Parts at Reasonable Prices
TRANSMISSION & ENGINE REBUILDS
Our Specialty
804-985-7924, Mon-Fri 8:00-6:00
Visa/Master Card

EDITOR'S REPORT--FINANCES & DUES INCREASE

After four years as editor there really has been no increase in dues except for the original one from \$6 to \$8 in 1980. Meanwhile many expense have increased in that time. Postage has gone from 15¢ to 20¢ (soon to 22¢); printing then was \$400 a month and now is almost \$600; the computer currently costs \$150 a month; folding labor is about \$80 per month; and a few modern office conveniences like a postage meter and copier all add up.

With gross receipts in 1983 of about \$52,000, the editors salary was less than \$7000. For those of you who don't know, this is a more-than-full time job with the responsibility to get the Newsletter out on time every month. In addition our working cash balance is fairly low--only about \$1500. The financial situation is not critical, but additional income is needed.

At the urging of several members and friends, I have reluctantly decided that the dues must be increased. Effective November 1, 1984, renewal dues will be \$12 for first class mail and \$11 for third class mail. Those of you who would like to renew before the increase may do so, with a two year maximum. Yes, this partially defeats the purpose of an increase, but it will serve the function of adding to our working balance. New member dues will also go up by the same amounts, to \$15 and \$14.

The added income will go toward three different areas: 1) increased salary for the editor 2) additional clerical help in order to free the editor for more creative tasks, and 3) larger editions of the Newsletter three or four times a year. Even at \$12 a year the Newsletter is still less expensive than most any other car club. We also plan to do more extensive advertising in order to expand the club beyond the 3200 members we currently have.

It has also been suggested that the Club should have some sort of Board of Advisors. This seems like a good idea and one that we will pursue.

A more detailed financial statement than the one above is available on request.

Jeff Delahorne, editor

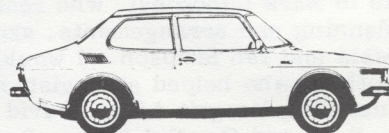

#3 Brickton Road Route 4
Princeton, MN 55371

612-389-3776

Turbo Oiler Kit (specifically designed for Saab Turbos. All lines are steel braid, and comes with complete instructions)-----\$75.00

99 Replacement Heater Core Kit, '74-80, New, complete with intructions, easily installed \$75

Counter Shafts, '77-80 99 & 900, New, Genuine Saab-----\$145

2.0L Rebuilt Cylinder Heads, with valves & cam
Non-Turbo, '73-80 (exchange)-----\$299
Turbo, '78-80 (exchange)-----\$399

SAAB SERVICE TIPS

SERVICE KIT TO IMPROVE DRIVEABILITY WITH COLD ENGINE--SOME '82 & ALL '83 NON-TURBO

Saab Service Info 06/84-692: A service kit (p/n 85-46-921) is now available which alters the function of the Lambda system until the engine coolant has risen to 77°F. This allows the engine and fuel system to stabilize before the Lambda system takes over mixture control and it improves driveability after a cold start of the naturally-aspirated engine.

The service kit may be fitted to specific naturally-aspirated M82 engines and all M83 naturally-aspirated engines having Lambda Electronic Control Unit P/N 93-45-216 (Bosch No. 0280-800-054). Note: It cannot be used on M82's with alternate "M81" Lambda systems identified by ECU P/N 93-37-718 (Bosch No. 0280-800-035), produced within VIN Serial No. ranges C1012287-29974 and C2006539-10800.

All other naturally-aspirated M82 models may be fitted with the service kit.

Installation Details:

Service Kit P/N 85-46-921 consists of the following individual components:

- 1 - Temperature Switch
- 1 - Gasket
- 1 - Harness
- 5 - Wire Clips

1. Drain the engine coolant to below the level of the thermostat housing.
2. Remove the large plug from the front of the thermostat housing.

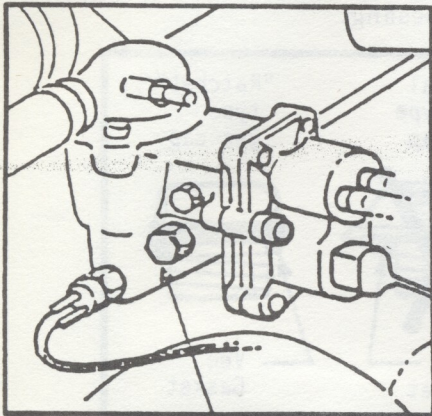

17 mm socket

3. Mount the sealing ring to the temperature switch and fit the switch to the housing. Refill, pressure check and bleed the cooling system.
4. Connect one end of the wiring harness to the temperature switch and route the harness along the existing wiring harness to the Emission Relay Panel. Attach the harness with the five cable ties included in the kit.
5. Detach the Emissions Relay Panel from the inner left wheel housing. Remove the relay board from

the panel and remove the Decel Relay "E" (Manual Transmission only). Cars equipped with automatic transmission do not use a decel relay although the socket for the relay is there.

Run the wiring harness from the temperature switch through the rubber grommet of the Emission Relay Panel. (See illustration below)

6. Remove Terminal 31 and Terminal X1 for the decel relay holder E.
 7. Insert the terminal from the black wire of the new harness to position 31 of the relay holder E. It should snap into place and not push out. Connect the black wire of the existing harness to the connector of the black wire from the temperature switch.
 8. Cut off the terminal of the red/yellow wire which was removed from position X1 of the relay holder. Connect this end by means of the crimp connector and special crimping tool (Saab P/N 78-60-695) to the crimp connector of the new harness.
 9. Refit the Decel System relay, the relay panel board and re-attach the entire assembly to the inner wheel housing.
9. Verify your repair as follows:
 - a. Connect a pulse relation meter.
 - b. Start the car and observe the pulse relation meter.
 - c. If engine coolant is below 64°F (18°C) the meter should lock on 60%.
 - d. When the temperature rises above 77°F (25°C) the meter should begin to oscillate normally.
 - e. A cold engine may be simulated for testing purposes by mumping the wire connections at the newly installed temperature switch.

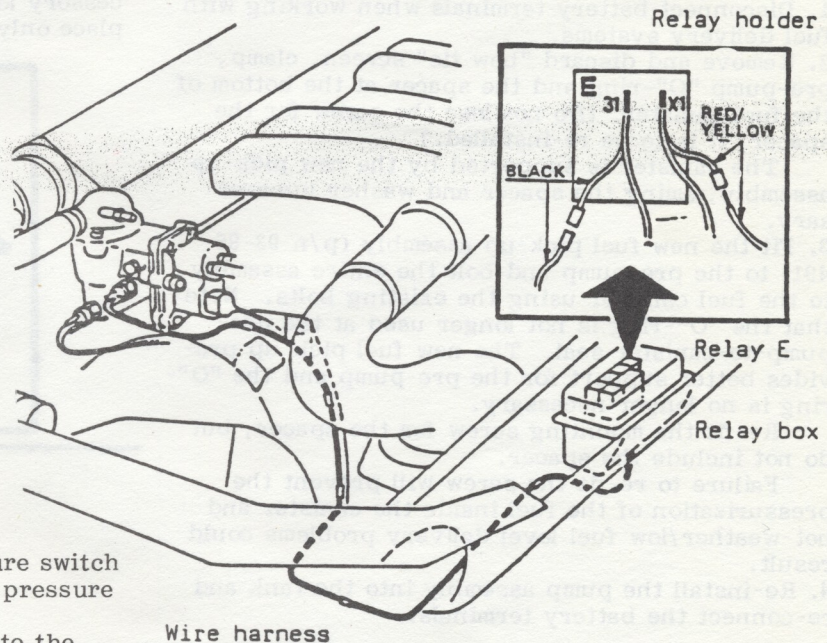

Wire harness

The Club thanks Mr. Daniel L. David, Manager, Technical Services Department, and Mr. Robert J. Sinclair, President, at Saab-Scania of America for making Saab Service Information bulletins available.

INTRODUCTION OF NEW FUEL PICK-UP MID-84

Saab Service Info: 07/84-695--During mid-M84 production and beginning with VIN Serial Nos. E1021336 and E2009858, a new fuel pick-up assembly was introduced which replaces the present "bow tie" pick-up screen. The new pick-up (p/n 93-86-491) reduces the chance that fuel delivery could be impeded by improper installation of the fuel pump assembly.

If repairs are necessary to cars equipped with "bow tie" type (p/n 93-49-689) individual components may be replaced until current parts supplies are depleted. In order to convert the new fuel pick up, please refer to the following conversion details.

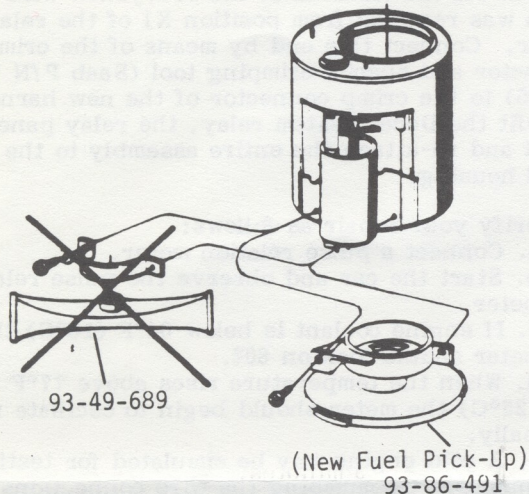
Conversion Procedure (if necessary)**NO SMOKING OR OPEN FLAME!**

1. Disconnect battery terminals when working with fuel delivery systems.
2. Remove and discard "bow tie" screen, clamp, pre-pump "O"-ring and the spacer at the bottom of the fuel canister. (Do not lose the screw for the spacer, it is to be re-installed.)

The canister is supported by the new pick-up assembly, using the spacer and washer unnecessary.

3. Fit the new fuel pick-up assembly (p/n 93-86-491) to the pre-pump and bolt the entire assembly to the fuel canister using the existing bolts. Note that the "O"-ring is not longer used at the pre-pump-to-canister seal. The new fuel pick-up provides better support for the pre-pump and the "O"-ring is no longer necessary.

Re-fit the mounting screw for the spacer, but do not include the spacer.

Failure to re-fit the screw will prevent the pressurization of the fuel inside the canister and hot-weather/low fuel level delivery problems could result.

4. Re-install the pump assembly into the tank and re-connect the battery terminals.

AMSOIL meets the challenge presented by turbocharged engines! Free information on the new 10W-30 TurboCharge Synthetic Motor Oil. Contact Wendell Emery, 1751 Pinta Drive, Holland, MI 49423

INTERMITTENT HOT FUEL DELIVERY M80-83-1/2

Saab Service Info 06/84-691: Intermittent interruption of fuel delivery during hot ambient conditions has been determined to be caused by deficient Evaporative Control System pressure. If components of this system are not meeting the original specification, or if the fuel filler cap is not properly tightened, the reduction in Evaporative System or tank pressure can cause vapor bubbles to form in the fuel and momentarily interrupt or cause a "miss" in the delivery of fuel from the fuel pump.

The usual symptom of this problem is an occasional jolt which is felt while driving on the highway at steady speed or when depressing the accelerator slightly such as when climbing a grade in hot, humid weather (above 80°F).

NOTE!: In order for the instructions in this S.I. to be effective, the car must be in stock condition, i.e., unmodified fuel pick-up trays, tank pressure valve in place and CIS pressures and ignition system within specification.

Details on the repair of this occurrence are detailed below:

1. Perform a check of the Evaporative Control System as described in S.I. 05/84-689. Repair any pressure leakdown faults with the aid of the S.I.
2. Replace the evaporative system pressure valve (p/n 93-03-462) as per the instructions in S.I. 05/84-689 if it does not open and maintain a pressure of at least 1.2 psi (0.08 bar) but not more than 2.2 psi (0.15 bar) for at least 5 seconds.

3. Install a ratcheting-type gas cap (p/n 75-10-530) noting the following:

M80 Models - if not already done, replace the filler neck with the appropriate M81-type, p/n 93-35-118. See S.I. 04/81-469 for details.

M81-83½ Models - if car is fitted with Saab accessory locking gas cap (also ratcheting-type) replace only if not sealing.

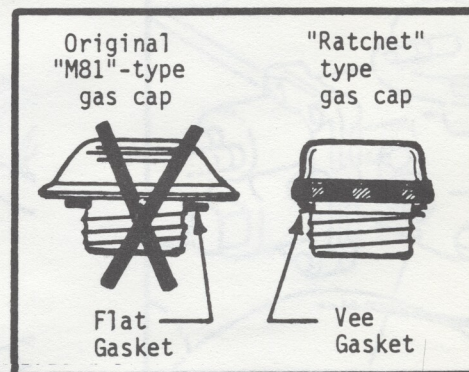

SAAB 900
AUTOMOBILES

TURBOS, 1981-ON, INCLUDING APC:
Water injection kit increases 25hp at the touch of a button. The Safety for Easy Overtaking!

3 DOOR, ALL MODELS: Customized with fender flares, side skirts, double size rear spoiler.

FRONT GRILLE FOR ALL 900's

Brochure \$2.00
Send Self-Addressed Stamped Envelope

CARTINA, INC.

Dept. SC, 5220 N.W. 72 Ave. Bay 35
Miami, Florida 33166

PRESSURE TESTING EVAP. CONTROL SYS. 81-83

Saab Service Info 05/84-689: Positive tank pressure is a feature of the Evaporative Control System. Vapor leaks between the fuel tank and the pressure valve will result in pressure loss from the Evaporative Control System and/or the possibility of a fuel smell in the interior of the car. Positive tank pressure is necessary for preventing intermittent fuel pump cavitation or vapor lock under hot ambient temperature and/or high altitude conditions. To identify a vapor leak or incorrect pressure condition on 1981-83½ models, perform a pressure test of the system according to this S.I. (NOTE: Follow S.I. 04/81-472 in Sec. 2, S.I. Supplement No. 2, when pressure testing 1979-80 900 Evaporative Control Systems.)

The Evaporative Control System for 1981-83½ models is depicted below.

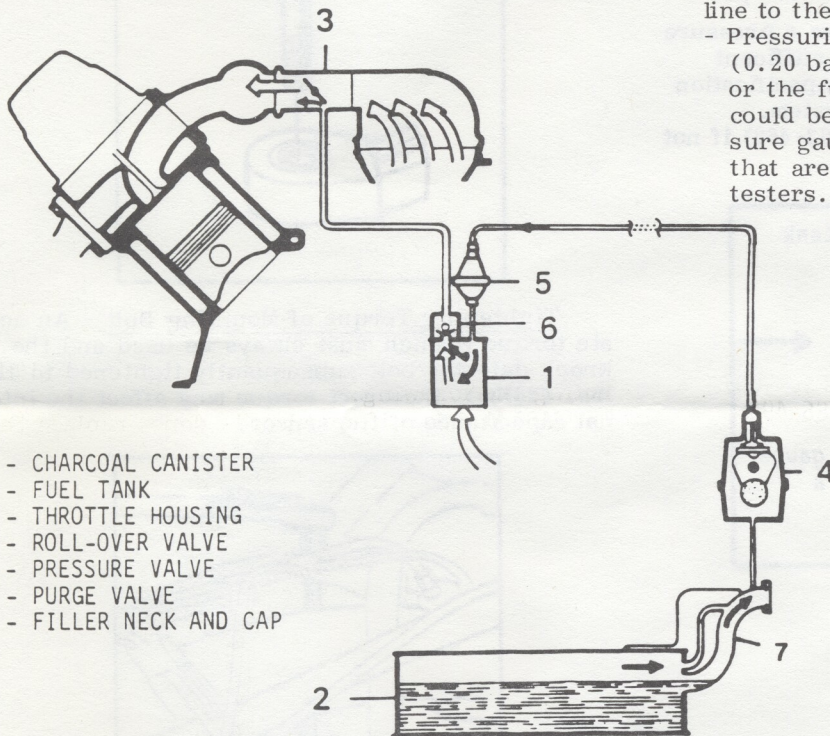

- 1 - CHARCOAL CANISTER
- 2 - FUEL TANK
- 3 - THROTTLE HOUSING
- 4 - ROLL-OVER VALVE
- 5 - PRESSURE VALVE
- 6 - PURGE VALVE
- 7 - FILLER NECK AND CAP

The following describes the process of artificially pressurizing the evaporative control system and detecting vapor leaks. No Smoking! Use Adequate Ventilation.

1. Locate the fuel tank vent hose to the charcoal canister and disconnect it from the pressure valve at the canister inlet. Air pressure will be applied through the vent line to the tank.

2. Connect, via a "T" fitting, an APC boost pressure gauge (P/N 83-93-514) and a shop coolant pressure tester (hand pump).

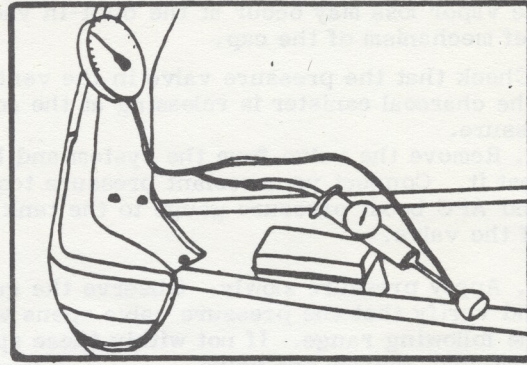

3. Slowly apply air pressure through the vent line to the fuel tank.

- Pressurize the system to a maximum of 3 psi (0.20 bar). Do not over pressurize the system or the fuel pump mounting or tank grommets could be dislodged! Observe the boost pressure gauge, it is more accurate than the gauges that are part of most shop coolant pressure testers.

- It may take some time to pressurize the tank, depending upon the quantity of fuel present (the lower the tank level the greater the volume of air required).

- Maintain tank pressure for at least 5 minutes.

- Shop coolant testers may not necessarily be air tight. If you suspect that yours is not, pinch off the hose from the pressure tester to the "T" fitting.

- You will notice some pressure fluctuation if the ambient temperature in which the car is sitting has recently changed.

DO NOT USE THE SHOP'S COMPRESSED AIR TO PRESSURIZE THE TANK!

4. With the tank under pressure (3 psi MAX!) soapy water or a HC/CO meter probe can be used to check for vapor loss at the filler cap, filler neck, vent hoses, tank grommets, vent hose connections, fuel pump and fuel level transmitter.

NOTE! You may get some inflation of the fuel pump bellows during this test, however, no damage to the bellows or pump will occur if the 3 psi (0.20 bar) pressure limit is not exceeded.

5. Tighten (if applicable) or replace any component which produces a vapor leak. Tank grommets which must be replaced and still leak may be sealed with a special sealant available from Saab, BOSTIK VE VE seal (p/n 30-21-250). Other type sealant must not be used as they may not withstand contact with gasoline or adhere to the HDPE fuel tank material.

CAUTION! Bostik VE VE seal is extremely flammable and must be kept away from open flames.

Continued on next page

24-48 Hour Service

Your #1 Source for O.E.M.
SAAB Parts in Wisconsin

Out of State Call Collect
(414) 771-2340

1-800-242-2003

Parts Open Saturday 9-1 p.m.
Volvo • SAAB • Subaru • Triumph

6102 W. North Avenue
Milwaukee, Wisconsin 53213

EVAPORATIVE PRESSURE TESTING, continued

Leaks at the filler cap may be difficult to detect. The gasket on the cap may appear to be good yet some vapor loss may occur at the built-in vacuum relief mechanism of the cap.

6. Check that the pressure valve in the vent line at the charcoal canister is releasing at the correct pressure.

A. Remove the valve from the system and bench test it. Connect your coolant pressure tester and APC boost pressure gauge to the tank side of the valve.

B. Apply pressure slowly. Observe the gauge and verify that the pressure valve opens within the following range. If not within these specifications, replace the valve.

VALVE OPENING PRESSURE: 1.3 - 2.0 psi

A pressure valve which opens at too low a pressure will not allow the fuel tank to maintain sufficient pressure. Opening above the maximum specification will cause excessive pressure in the system.

Replace the pressure valve (p/n 93-03-462) if not within specification.

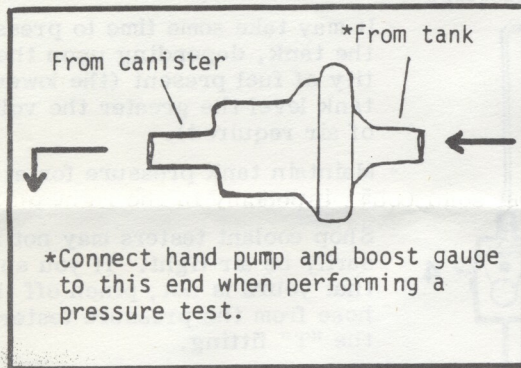

PROPER INSTALLATION OF APC KNOCK SENSOR

Saab Service Info 06/84-693: A Bosch-brand APC knock detector and shielded cables which has been improperly installed may transmit a false signal to the APC control unit.

The following must be noted anytime the knock detector has been replaced or otherwise disturbed and whenever the shielded cable from the knock detector to the control unit has been moved.

Knock Sensor Mounting Bolt - Never substitute the mounting bolt for the knock detector for any other bolt. The correct bolt is Saab P/N 80-82-968 which is a M8x25mm, 8.8 graded bolt. Installing washers or other types of bolt heads is prohibited.

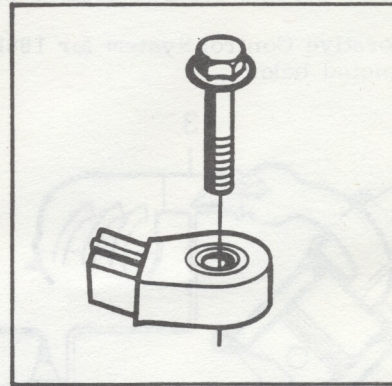

Tightening Torque of Mounting Bolt - An accurate torque wrench must always be used and the knock detector bolt subsequently tightened to 15 ft. lbs. (20Nm). Incorrect torque may affect the internal capacitance of the sensor.

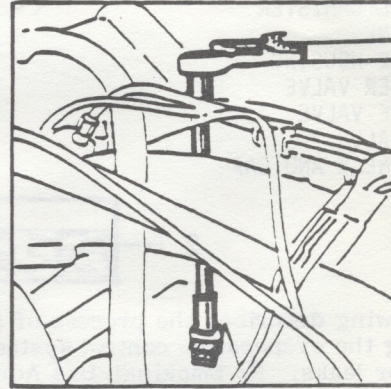
Routing of the Sensor Wire

°Hoses and other engine components must be secured so that they do not come in contact with the knock sensor.

°When tying the knock sensor wire to coolant hoses, always leave a little room for expansion. An expanding cooling hose could impeded the signal from the knock detector and could possibly damage the shielding of the wire.

°The wire must not be tied to or allowed to come in contact with the intake manifold or the engine block.

°Avoid sharp bends when routing the wire and do not allow it to pull tightly on any of its connections.

QUALITY SAAB PARTS

at

SUPER DISCOUNTED PRICES

BOGE Shocks - All Models.

BOSCH Electrical

ENGINE PARTS - A E, Glacier, Reinz, Victor, etc., for 93's to 900's

LUMINATION OPTRONIC Ignition Systems (Lifetime Warranty)

Plus - Clutch, Brake, Chassis, Exhaust, Tune-Up, Books & More!

Call or write for a free catalogue of all our SAAB parts

Dealer Inquiries Welcome

Same day shipment with M/C, VISA or C.O.D.

ABP, Ltd.P.O. Box 109, Mechanicville, N.Y. 12118
Drawer R, Lewiston, CA 96052(518) 664-4966
(916) 778-3978

PARTS MART

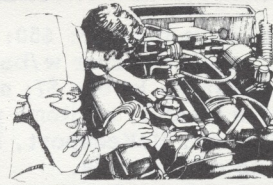

CLASSIFIED AD RATES

Ads offering parts or Saabs for sale or wanted at prices under \$200 are FREE to members and non-members. 25-word limit, plus name and address. Ads listing prices of \$201 to \$900, enclose \$2. Ads listing prices \$901 to \$2000, enclose \$5. \$2001 and up, enclose \$10. All ads without a price listed, enclose \$10.

Commercial ads: contact Editor for rates and info. We will delete all unnecessary superlatives and abbreviate where possible. Please enclose sufficient funds with ad copy; we will not bill.

CLASSIFIED AD DEADLINE

The Classified Ad deadline for the September issue will be Sept. 4th and the deadline for the Oct. Newsletter will be October 1st.

SONETTS FOR SALE

1967 Sonett II, serial #000198, runs well, just passed inspection, rbld oil-inject. 850 eng., rbld trans. rbld radiator & alternator, new water pump, 175/70-15 steel radials, int. rough, could use paint, some rust, quick car: \$2500. Thor Carlson, 326 Morris Ave, Boonton, NJ 07005, 201-334-1738.

1968 Sonett V-4, very special, serial #00305, factory wood dash, 110 hp engine, rbld trans., brakes, electrical sys., & suspension, Konis, Michelins, new interior, Fast!: \$3975 or consider partial trade. Jack Ashcraft, 503-664-5259.

1969 Sonett V-4, 66,000 mi., recent new: engine, tires, brakes, battery, paint; no rust, never wrecked, runs good, a little hard to shift (linkage?) asking \$2650. Dale Deratany, 633 N. 5th St., Cottonwood, AZ 86326, 602-634-2347.

1971 Sonett, mellow yellow w/black lower stripe, new paint & rbld mechanicals, in good running cond. orig. int. needing minor work, Has been stored last 2 yrs: \$3500. Delbert Timmerman, 817-797-5121.

1972 Sonett, California Burgundy, am-fm cassette, A/C, never seen snow: \$2350. Jeff Letterle, 603 5th St., Palmetto, FL, 813-722-5481 anytime.

1973 Sonett, exc. cond., new tires, 77,000 mi., \$3000 or best offer, must sell. Seth L. Goldstein, 230 California Ave, San Leandro, CA 94577.

95's and 96's FOR SALE

1966 95, 3 cyl, 32,00 on eng., good int., needs paint, little body work, mechanically sound: \$900 firm. Bruce Markel, III, 136 So. Main St., Browns-town, IN 47220, 812-358-3200.

95's and 96's FOR SALE, continued

1967 Saab Monte Carlo 850, spare tri-carb setup and velocity stacks: \$750 or best offer. David P. Borden, 617-639-1407, Marblehead, MA

1968 96 Deluxe for parts car, no engine, good trans misc. body parts: \$200 obo. 1969 96, basically sound body, complete drive train; needs some repairs: \$400 obo. Other misc. parts for sale. Jim Sanders, 11461 Upton Rd., Grand Ledge, MI 48837 517-627-3460.

1968 96, moon roof, new upholstery, A/C, am-fm stereo w/ tape, V-4, nice car, very little rust: \$1400. Also web-cased trans. from '68 V-4, exc. cond.: \$200 Sig Almquist, PO Box 22296, Lake Buena Vista, FL 32830.

1969 96, good engine & trans, body has some rust, new battery & exh., runs well; many extra parts incl. eng., wheels, clutch, alt, dist, & carb: \$600 for entire package. Jamie Tandlich, 35 Haendel St., Binghampton, NY 13905, 607-798-1045.

1971 96, solid body, especially in the right places, runs good, new clutch, needs brake & exh. work, includes many spare parts: \$1100. Tom Franko, 3512 Mayfair, McKeesport, PA 15132, 412-672-6622, eve's, no collect calls.

1971 95 wagon, eng. & trans. rbld 5,000 mi. ago, clean int., new carb, clutch & CV joints, body & trans. need some work: \$600, Charles Young, 750 Edmonds St., Edmonds, WA 98020, 206-774-4124 Wk 775-4727 home

1971 95, 175,000 mi., Ariz. car, no rust, 25,000 mi on rbld eng., white w/red interior, very good cond. \$1800 obo. ALSO 1973 96, 110,000 miles, Ariz. car no rust, new cloth interior, Sonett mags w/new tires, new carb, exh. & shocks; good condition: \$2500 obo. Nelson Garrison, 602-839-3859

1973 96, one owner, well-maintained, needs bal. shaft gear, light rust & dent in left fender, underbody has heavy rust, eng. good: best bid over \$700. L. Ball, 629 Kenwood Pkwy, Mpls, MN 55403 612-374-1106 M-F 1-4:30 or 374-5371 eve's.

95, 96, & SONETT PARTS FOR SALE

One slave cylinder (Girling) part # 880919: \$20 + shipping. G. Kovatch, 214 Kilbirnie Dr, Pittsburgh PA 15108.

Two rebuilt Sonett gear boxes, all new bearings & synchro's; one box 5000 since rebld: \$525; Other no miles: \$625, plus freight. Ron Hunter, Box 1714 Cave Creek, AZ 85331, 602-488-2112 eve's.

Classified Ads continued on next page.....

95, 96, and SONETT PARTS FOR SALE, cont'd

From '70 96, complete from bumper: \$50; tailite lens \$9; windshield: \$25; outside mirror w/base: \$15; heater core: \$10; handbrake lever: \$7; many more parts avail., inquire w/ SASE, all items plus post. Tom Franko, 3512 Mayfair, McKeesport, PA 15132, 412-672-6622 eve's, no collect calls.

V-4 radiator: \$75; V-4 tach: \$45; 2-stroke bulb-type temp. gauge: \$25; 95 tail-light ass'ys & lenses: \$15; many other 95/96 parts, new & used. Quantum Mechanics, 45 Huntington Ave, So. Yarmouth, MA 02664, 617-394-5193.

1964 engine w/new internals & Alsbury crank, still in boxes, 4-speed & many misc.: \$350. Neal Zeilinger, Route 2, Box 65, Neola, IA 51559.

95, 96, & SONETT WANTEDS

Wanted: New air filter; blue hood ornament for '60 Saab 93F. What else do you have? John Letterle, 345 Windsor Rd, Asheville, NC 28804, 704-258-8328

Wanted: Original tool kit and/or orig. wheel bolt wrench for mid-60's 2-strokes: \$?? Also door, ignition & hatch locks & keys for '66 95: \$40 or ? Owners manual for '65 Monte Carlo: \$10. Judy Berrian, 3615A 6th Ave NW, Olympia, WA 98502, 206-866-9302.

Wanted: stainless steel exhaust system for 96. Jim Sanders, 11461 Upton Rd, Grand Ledge, MI 48837.

99's and 900's FOR SALE

1974 99LE 103,000 mi., 4 dr. A.T. (20,000 on rbl'd) A/C; recently replaced: alt., water pump, front end suspension, battery, other misc., exc. cond.: asking \$2,000. Kris Thompson, Seattle, WA, 206-323-7584 H, 462-2411 wk.

1980 900 EMS, 36,600 mi, carmine red, auto., P/S sunroof, alloy wheels, gas shocks, exc. cond: \$7600
1978 99 Turbo, 60,300 mi, silver, sunroof, alloy wheels, good cond.: \$5600. Nelson W. Trivett, 1125 Westridge Rd, Greensboro, NC 27410 919-292-4895.

1983 900 3 dr. Turbo, slate blue metallic, Lux. trim leather seats, fog lights, elec. sun roof, cruise, only 8500 miles: \$15,500. Lew Bowen, 304-342-2003 1325 Mt. Vernon Pl., Charleston, WV 25314.

99 & 900 PARTS FOR SALE

1.85 cyl. head, new springs & guides: \$200; late 99 2-pc exh. manifold: \$75; 99 lower control arm, reinforced: \$55 ea; Used 99 trans. '73-74: \$250; '76 grille: \$45; 900 Dashboard: \$125. Quantum Mechanics, 45 Huntington Ave, S. Yarmouth, MA 02664, 617-394-5193.

Four Pirelli P6 195/60HR15 mounted on EMS wheels, run 2 summers, asking \$500; 2 KYB front shocks: \$20; '77 EMS Air Dam, VG cond.: \$80; Linear 90W amp: \$60. Keith Mathews, 6005 Burns St, Schofield WI 54476

Sunroof wind deflector: \$50; 900 trailer hitch: \$75; '79-80 Engine & elect. books: \$10; '80 Turbo center section: \$75; 99 Quartz clock: \$35; Comer Buck, 122 Carolina Blvd, Isle of Palms, SC 29451

99 and 900 PARTS FOR SALE, continued

'74 99 parts: manual trans.: \$200; cyl. head ass'y: (minor chain groove): \$150; exh. manifold, no cracks: \$40; Instrument cluster: \$40; much more out of blue 4 dr, 2.0L. Karl Hodge, 79 Maple St., Cuba, NY 14727, 716-968-1460.

Four stock wheels from '79 900 GLi, in exc. cond. no rust, incl. trim rings, caps, lugnuts, each w/ Mich. XZX 165-15 mounted/balanced (one tire new, others 35% worn): \$150 per set obo. Dick Brill, 136 Fernwood Dr., Glenview, IL 60025, 312-998-5777.

TRX wheels and tires from '80 Turbo, 5 for \$375 or \$80 each. Also 99 trailer hitch, complete w/ changa lite and wiring, \$80 + shipping. Joe Fox, 312-420-4405 days.

One full hubcap from '75 99: \$10 + shipping; Marantz Electronic High Temp ignition wire set, silicone \$10 ship. G. Kovatch, 214 Kilbirnie Dr, Pittsburgh, PA 15108.

Left and right tailamp assemblies for Hatchbacks '77 until '79 (lens/bulbs/cluster): \$35 ea or both for \$60 delivered. J. Maymon 615-646-1305 eves

Dashboard for 900, slight damage: \$150; Rear bumper bike rack, made in Sweden, very sturdy: \$75 Alex Thomas, Glastonbury, CT, 203-659-0643.

Complete '79 Turbo engine, under 5000 mil, w/turbocharger, manifold, exh. manifold & wastegate, distrib., head, etc; eng. has been properly stored & parts free of corrosion, crated & ready to ship: \$1200 plus ship., or trade for good strong Saab car, model & year not important. Dr. Dixon, Lower Plain, Rt. 5, Bradford, VT 05033, 802-222-4682.

Bosch Jetronic Service Manual, 2 orig. binders with latest updates; equip. lists & workshop manuals for all cars using D, L and K (CIS) fuel inj., '68-83. Like new, \$60 incl. shipping. Bernie Wassertzug, 11825 Enid Dr., Potomac, MD 20854.

KYB gas shocks for 900's: \$25 ea. Roll bar for 99, not SCCA-legal but stout: \$25 plus freight; Jeff Delahorne, 5805 Oneida St., Duluth, MN 55804, 218-525-3253

99 and 900 WANTEDS

Wanted: left rear trim panel for '78-80 3 dr, reddish color, must be like new, no burns or cracks. Call collect if you have it: J. Maymon, 615-646-1305.

Wanted: 99 EMS or Turbo spoiler, Quantum Mechanics, 45 Huntington Ave, S. Yarmouth, MA 02664, 617-394-5193.

Wanted: Factory parts manual for '73 99E: \$40? Jim Brigham, 9813 19th Ave. NE, Seattle, WA 98115 206-527-8175.

Wanted: for '78 EMS, lower half plastic steering column cover, will pay \$20. Thor Carlson, 326 Morris Ave, Boonton, NJ 07005, 201-334-1738.

Wanted: Air Cond. compressor mounting bracket for '74 99LE, will pay reasonable price plus ship. W. Sigrist, 85 Grant Ave, Dumont, NJ 07628, 201-385-7013.

Wanted: 2.0L exhaust manifold that does not have hole for motor mount-to-manifold bracket--will trade for one that does? Brian Harris, Rt. 8 Box 56, Abingdon, VA 24210, 703-669-9171 D, 628-3794 eve's

HOT STARTS & ADJUSTABLE THERMO SWITCHES

I am pleased to share with other members some modifications I have done on my cars (1976 99 EMS 4 spd. and 1978 99 GLE, auto.).

First, a \$1.00 solution to difficult "hot starts." By pass the action of the "thermo-time" switch (when the engine temperature is above 35°C or 45°C depending on the model year) by a momentary "on" switch which I installed on the plastic housing of the steering wheel. This way if a warm engine refuses to start, you press the button; this will activate the cold start valve and the engine will start immediately. You should also depress the gas pedal while doing this.

A momentary on switch is recommended to avoid forgetting and leaving it in the "on" position.

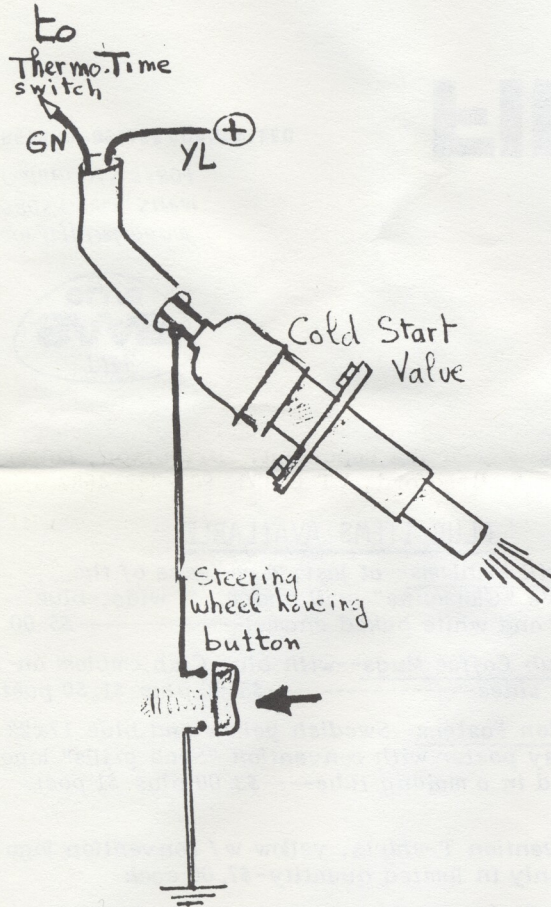

Adjustable Thermo-Switches--This includes the radiator fan thermo-switch (one-blade contact) and the cold start valve thermo-time switch. Remove the switch (from the radiator or engine block). With a very sharp "pointer" carefully remove the small seal (plastic on some cars, brass on others-- for the brass you need a hammer). Under the seal is a small screw which you can adjust to the desired "closing" temperature. After adjustment, you can "seal" the screw with a pencil eraser.

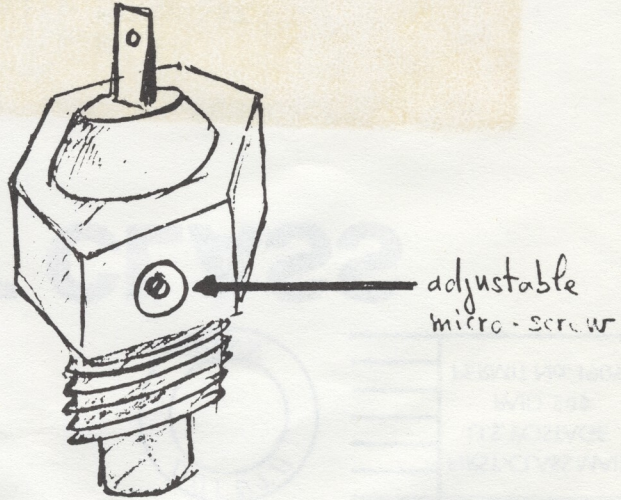

Poor driveability during warm-up--This is due to wrong fuel pressure given by the electrically heated warm-up regulator. The solution is to reduce the heating by inserting a resistor. I added an adjustable resistor (20 ohm/20 watt) found in any auto-radio store (fader control). I installed it in a Kodak plastic film container (35mm). The best way is to check your fuel pressure and adjust accordingly.

Joel Soumagne, Sherbrooke, Que.

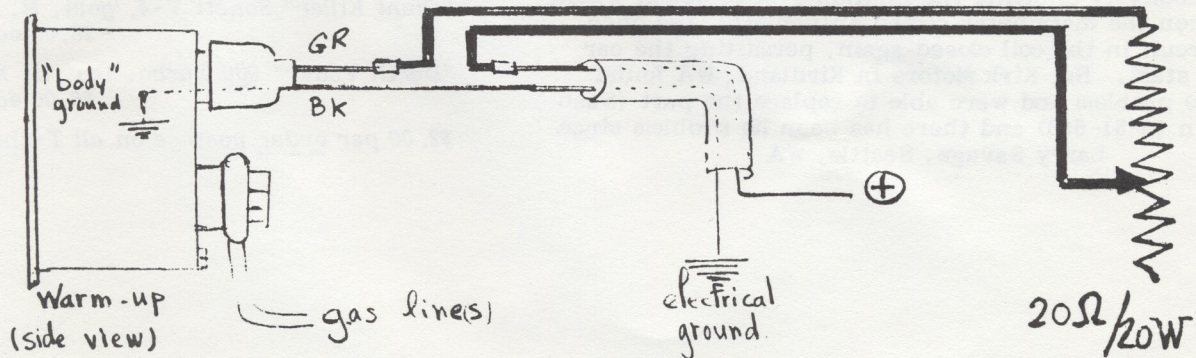

Please use knife/letter opener

SEPT. 1984



FIRST CLASS

RETURN POSTAGE GUARANTEED

c/o Jeff Delaborne
5805 Oneida Street
Duluth, MN 55804



FIRST-CLASS MAIL
U.S. POSTAGE
PAID 20¢
PERMIT No. 1909



ELECTRONIC IGN. PICK-UP COIL FAILS IN 900

I would like to pass along the fix to a problem that I had with my 1981 900 Turbo. I don't know how prevalent it is, but it causes copious quantities of grief when it occurs. The car would run fine for about 20 minutes and then die. It would not re-start for about 45 minutes. It would then run well for about 15 or 20 minutes and die again, requiring another cool down period of 45-60 minutes. The weather was warm at the time (75-85°F). Some sort of vapor lock?

The problem turned out to be an open circuit (intermittent, of course) in the magnetic pick up coil in the Bosch distributor. Apparently what happened is that when the temperature under the hood rose to a sufficient level, the coil winding opened, effectively shutting the ignition system down. Then, when the distributor cooled sufficiently, the open circuit in the coil closed again, permitting the car to start. Bel-Kirk Motors in Kirdland, WA found the problem and were able to replace the part (Saab p/n 93-51-693) and there has been no problem since.
Larry Savage, Seattle, WA

CLUB ITEMS AVAILABLE

- Brass Grill Emblems--at last, a re-issue of the Club's "Cloisonne" grill badge, 3" wide, blue gold and white baked enamel-----\$5.00
 - White Club Coffee Mugs--with blue Club emblem on both sides-----\$5.00 plus \$1.50 post.
 - Convention Posters--Swedish yellow and blue 17x22 glossy poster with convention "Saab grills" logo rolled in a mailing tube-----\$3.00 plus \$1 post.
 - T-Shirts
 - Convention T-shirts, yellow w/ convention logo XL only in limited quantity-\$7.00 each
 - "Old Saab-ers" 96 two-stroke, light blue, XL only-----\$6.00 each
 - "Giant Killer" Sonett V-4, gold, M, L, XL \$6.00 each
 - "Darth Vader" 900 Turbo, tan, L, XL only \$6.00 each
- \$2.00 per order postage on all T-shirt orders.