

THE SAAB CLUB

AUGUST 1984, NEWSLETTER #129

ONTARIO SAAB OWNERS ADV. DRIVING SCHOOL

Ontario Saab owners are invited to join us for the Fourth Annual Saab Owners' Club Advanced Driving School at Shannonville Motorsport Park (near Belleville) Sunday October 21, 8 am. The cost is \$60 for members and \$70 for non-members, with a \$10 deposit reserving a place.

Preparation includes classroom, practice on attitude, seating, steering, heel & toe, braking, turning, all with a front-wheel drive emphasis. Track includes instructor, food, and refreshments. Groups will be arranged by skill and previous experience with ample on-track time for all. For even and club info, call Derek Hanson, 416-294-4063 or Dan Willison, 416-222-8066.

APPALACHIAN SAAB CLUB--will be meeting the third Tuesday of each month at Pennington's Fund Raising Co., 214 Market St., Johnson City, TN. Anyone interested in Saabs is welcome. For more information, call Mike Woods, 615-753-2101 or write Rt. 6 Box 349, Jonesborough, TN 37659.

SAAB CLUB NATIONAL CAPITAL AREA-- is now meeting on the third Tuesday of each month, still at the Silver Spring Public Library. Outdoor session begins at 7:30 with the formal, indoor meeting at 8 pm. For more info, contact Toby Turpin, 301-384-6732.

SONETT CLUB OF SOUTHERN CALIFORNIA--meets the second Thursday of each month at Antique & Classic, 18315 Mt. Baldy Cir., Fountain Valley, CA. For more info: SSCSC, PO Box 665, Sierra Madre, CA 91024.

SAAB CLUB OF SOUTHERN CALIFORNIA--meets the third Tuesday of each month at the same location at the Sonett Club. Parking lot meeting at 7 pm, indoors at 8. For more info, contact Paul Florance, 54-62nd Pl., Belmont Shore, CA 90803.

NEW ENGLAND SONETT CLUB MEET AT SAAB HQ

Our July 28th meeting at the headquarters of Saab-Scania in Orange, CT was an outstanding success. We counted 46 Sonetts and about 175 members and guests in attendance.

After opening remarks by Bob Sinclair, Len Lonnegren, Bill Murray and Alex Lieuwma, we split the group as there wasn't a room large enough to accommodate all.

Parts were sold from the receiving stock area at most welcome prices, service representatives helped answer Sonett owners' technical questions, Saab movies were shown, a caterer provided fine food and beverages and Saab gave each attendee a complimentary "From Two-Stroke to Turbo" book, Sonett III Service Manual and a Saab raincoat.

The distance record went to Butch Stevens from Colorado, but we also had members from Michigan, Ohio and Delaware.

We don't know of another car manufacturer that would do anything like this for owners of older cars. Saab is really a car company that cares.

MILWAUKEE SAAB CLUB-- is having a party at Pat and Margo Greer's, 1810 E. Jarvis, Shorewood, on Friday August 24, starting at 7:30 pm. A new batch of the popular MSC T-shirts will be on sale.

On Monday, September 24, at 7:30 pm, there will be an indoor tech session on emergency roadside repairs and tools required, at Shakey's Pizza, Hwy 100 and Silver Spring. For more info, call 964-7463.

TULSA SAAB CLUB-- next meeting will be Aug. 28th at the Sizzler, 18th & Yale, 6:45 pm. Future meetings will be the fourth Tuesday of each month. Ray and Pam Kurr received the winner's trophy for the Club's June Rally along with a \$25 gift certificate from Passport Motors. For more info, call Jim Glavas, 918-663-8087.

CENTRAL ILLIANA SAAB CLUB--will meet September 16, 2 pm at Margrit Adler's house, 1507 W. University, Champaign (ph. 217-356-9244). Randy Riggs will do a session on "All about Clutches." Call if coming from a distance to make sure of the location.

Saab Clubs of North America

Editor and publisher: Jeff Delahorne, 5805 Oneida St., Duluth, MN 55804

(218) 525-3253 9 a.m.-8 p.m. except Sunday

Consultants: Dick Grossman, Jack Ashcraft, Carolanne Curtis, Andy Buc, Ted Tucker

1980 99 HAS HIGH OCTANE THIRST, PINGING

The only problem with my '80 99 to date is one that I can live with, but would like to pose to Club members for advice or comment. Up until about 30,000 miles, my 99 ran well on the regular-grade unleaded gas, 87 octane as marked on the pumps in this area. For the last 15 months, the engine has knocked routinely under heavy load at relatively high engine speed (over 3500 rpm). Using unleaded premium (91 octane) reduces but does not eliminate the knocking. The dealer shrugged his shoulders and said to use premium fuel when I asked him. Re-tarding the timing about 4° from normal spec eliminates the knock (with 91 octane), but the car loses a little zip and gas mileage drops.

Perhaps combustion chamber deposits have effectively increased the compression, but I would prefer to have clean chambers and use 87 octane. I would like to know if other Saab owners have experienced this craving for high-octane fuel, and what, if anything, was done to alleviate it.

Tires & Shocks -- Significant replacement items this year included tires and shock absorbers. At around 50,000 miles those hard, slippery Michelin XZX's warranted replacement, so I got Vredestein 185/70-15's. I'm sure they don't offer the ultimate in sheer cornering power, but: a) they fit the five inch stock wheels just fine with plenty of fender well clearance; b) they are the proper size to maintain speedometer calibration, and c) they don't cost an arm and a leg (about \$53 mail order). The changes I find noticeable are much improved traction in the wet and snow, which includes braking. Cornering is improved, probably due to the wider footprint. The ride is generally better, although I detect some "clunkiness" on bumpy roads, probably because of the increased weight of the tires. For all these improvements, I've suffered a very slight (1/2 mile per gallon) decrease in gas mileage.

Koni gas shocks were installed shortly after the new tires. These are adjustable units and I put them on (per Koni's recommendation) at full "soft." Again the ride improved over all but broken/potholed pavement. The slight additional spring rate due to the gas pressure, plus the improved damping have firmed up the ride just a tad--but nicely.

Gary A. Smith, So. Windsor, CT

OIL FILTER GASKET CAUSES LEAK IN '82 900

Our '82 900 had been plagued by a chronic oil leak which was difficult to trace down. One morning I saw an unusually large pool of oil on the driveway and then and there decided I had better find out where the leak was before an engine burned up. My wife had driven the car to work, so I went there and observed another large pool of oil under the oil filter area of the car. I watched the oil filter as the car was started, and sure enough oil was oozing from around the perimeter gasket. I changed the filter from the Fram PH16 I had been using to a Mann W920/21. Again I observed the gasket area of the oil filter as the engine was started and this time no oil came out. Since then the oil leakage has stopped completely.

As a matter of curiosity, I measured the gasket sizes of the two filters as I noticed the Mann appeared to be larger in diameter and thicker than the Fram it replaced. Here are the dimensions:

	Gask. OD	Gask. Thick.
Mann W920/21	2.815"	0.102"
Fram PH16	2.725"	0.056"

What the significant differences are I am not certain, but I do feel that they possess the potential to cause the oil leak problem I was having.

F.A. Delahorne, Tulsa, OK

'84 BACKUP LIGHT SWITCH CAUSES PROBLEMS

1984 cars have a new-for-'84 backup light switch which has resulted in strange things happening to my car. If I put the car in reverse all the warning lights go on and the tach goes dead. The cigarette lighter, on the same fuse as the backup lights, blows the fuse. Saab is replacing the switch but I thought other Club members who might have the same trouble would be interested.

If you put the car into a forward gear, the warning lights still stay on until you rev up the engine, then the tach also begins to operate. It looks for all the world as if the alternator has failed. You should disconnect both plugs for the backup switch at the base of the gear shift lever until the switch is fixed, though you will still have all the lights come on and the dead tach while in reverse. How all this happens I cannot understand.

The dealer list is great--I'll keep it in the dash of the car.

Steve Rowson, DeWitt, NY

Ed Note: See Saab Service Tips on page 7 of this issue for more information about the reverse light switch on the '84's.

MEMBERSHIP/SUBSCRIPTION

Dues for membership/subscription are as follows:

First year, third-class mail	\$11.00
First year, first-class	\$12.00
Renewal, third-class	\$ 8.00
Renewal, first-class	\$ 9.00

First-year membership includes two back-issue newsletters, Club tech sheets and emblem. Renewal notification will be stamped on the open rectangle at the top of this page. A treasurer's report will be made three times a year. This is a nonprofit organization.

A collection of 15+ back issues with Club tech sheets punched for your 3-ring binder is available for \$8.00 postpaid. Individual back issues: 75¢ each.

Always specify: 96, 97, or 99/900 for appropriate tech sheets.

Factory Trained N.I.A.S.E. Certified
THE SWEDISH SOLUTION, Inc.
 Saab Performance Specialists
 34300 Chagrin Blvd
 Moreland Hills, OH 44022
 216-831-6424

COMPLETE ORIGINAL PARTS INVENTORY
 Fuel Injection - Turbo - Suspension
 Service Inspections

Guaranteed Low Prices Same Day U.P.S.

YELLOW FOG LIGHTS ARE BETTER THAN WHITE

Copyright © 1984 by Charles Maurer

If you're buying fog lights, the odds are that the salesman will try to sell you white ones instead of yellow. "They're brighter." Yet in fog and snow, that extra brightness does not aid visibility, and it's annoying to boot.

The reason is that the extra brightness comes solely from the red and blue ends of the spectrum, and the eye's rods--the visual receptors responsible for night vision--are relatively insensitive to reds and blues. Thus as the limits of visibility--at the edge of your lights--the red and blue components of white light do not help you see. On the other hand, those reds and blues will obtrude themselves into your eyes as glare when they reflect off water droplets and snowflakes. During snowstorms and heavy fog, I usually turn off my headlights, even though they're H-4 halogens, which cause less glare than sealed beams. Instead I drive by yellow fog-lights (halogens) alone. They seem dim for the first half minute, but once my eyes adjust to the lower illumination, I can see quite as far as with the headlights on--and much more comfortably. In range and comfort, driving this way in a snowstorm is like driving with ordinary (non-halogen) sealed beams on a clear dark night.

Another advantage of yellow comes when you use fog lights on a clear night, which I do routinely for two reasons: (1) fogs project light sideways a vast distance, so you can spot a dog or a deer running on the far side of the shoulder, and so the road won't momentarily disappear in a sharp corner; and (2) on a dark freeway with cars far away yet too close to permit using high beams, fogs extend your visibility slightly. Slightly, yet enough to add a significant margin of safety. However, although it's sensible to drive with fog lights always on, and although fog lights don't dazzle other drivers if they are aimed properly, yet North American drivers are not used to them. Hence the second advantage of yellow: on-coming drivers (and cops) don't confuse them with high beams, so they don't flash you down (or pull you over).

You can modify Saab's fog-light wiring to work without the headlights by changing oen connection within the fuse box: find the wire leading from the fog-light circuitry to a headlight fuse, and move it to a parking light fuse instead. Also, if you're going to run without headlights, you should move the fog lights to underneath the headlights, to define the car properly. (When you're running with fogs instead of headlights is when you need this definition the most!) A bumper support is in just the right spot to hold a fog-light bracket, but Saab's bracket won't fit. I had a stouter pair than Saab's made by a wrought-iron shop for \$10. Saab's brackets I use above the bumper to hold driving lights.

For whatever it's worth, I bought Bosch Pilot fog and driving lights, then replaced the fogs with Hella 155's after I smashed the Bosch ones. My impression is that the Hellas are brighter. And if I ever smash the driving lights, I'll replace them with Hella 162's. I've never seen these in use, but from my experience with lights and lighting, it looks to me from their construction and proportions that they would provide a more useful pattern: a smaller but more penetrating hot spot with more spillage toward the side. In addition, the Hellas are less likely to

be damaged, for they protrude less than the Bosch; and although the Hella 155's are taller in the face, they hang no lower once they're mounted.

If you do buy Bosch Pilot fogs, and if you intend to use them for light rather than decoration, then do not put on the fancy protective grilles. The grilles make the lights more difficult to clean, and they block much of the oblique radiation, thereby reducing the lights' intensity so much that they are hardly worth installing.

Charles Maurer, Hamilton, Ontario

205/60-15 TIRES & REAR SPRING AIR BAGS

I put 205/60HR15 tires on all four wheels on my 900. The fronts were okay, but the back wheels scraped when going over bumps in the road. I found that J.C. Whitney has air bags for the rear springs of 99's and 900's for \$49.95 and they are exactly the same Poly Air set sold by Saab. You must remove the rear springs to install the bags. It took a klutz like me 1½ hours to install both of them, so if you can read English there should be no problem. I've had mine installed for a year now with no problems.

I noticed in the book From Two-Stroke to Turbo that Saab used a 16-valve head for the 99 in rally-ing. Is this setup available through parts suppliers or only made by Saab for its racing teams? If anyone knows, please inform.

Leo Skrzypek, E. Hartford, CT

Ed. Note: The twin-cam, 16-valve head that Saab used for a short time in the mid-'70's on the 99EMS rally car was designed specifically for racing applications and was not easily transferred to the street. I was told by one Saab official that, while there were 200 heads cast in order to meet FIA regulations, only a handful were ever used as they required many, many hours of machine work beyond the original casting.

Since Saab always preferred to race and rally highly-tuned versions of their regular production vehicles, the EMS twin-cam project was doomed when the turbo engine development began. While some of the lessons learned in the first twin-cam Saab head may have been useful in the current design, it does not appear that there is any other connection between the two.

QUALITY SAAB PARTS

at

SUPER DISCOUNTED PRICES

BOGE Shocks - All Models.

BOSCH Electrical

ENGINE PARTS - A E, Glacier, Reinz, Victor, etc., for 93's to 900's

LUMINATION OPTRONIC Ignition Systems (Lifetime Warranty)

Plus - Clutch, Brake, Chassis, Exhaust, Tune-Up, Books & More!

Call or write for a free catalogue of all our SAAB parts

Dealer Inquiries Welcome

Same day shipment with M/C, VISA or C.O.D.

ABP, Ltd.

P.O. Box 109, Mechanicville, N.Y. 12118
Drawer R, Lewiston, CA 96052

(518) 664-4966
(916) 778-3978

LAMBDA RELAY CAUSES HESITATION--OTHER TIPS

I recently experienced some intermittent engine hesitation on my '81 900 Turbo. It seemed to occur in the 2500--3500 rpm range under light load. After consulting all the hesitation references in my Newsletters and not solving the problem I realized I was on my own. While checking my fuel pressures and Lambda Sond system I noticed the modulating valve (which controls fuel distributor pressure) was cutting in and out in a random manner.

From the wiring diagram it appears that power is supplied to this modulating valve via the Lambda Relay (p/n 85 36 401) and the modulation frequency, hence fuel pressure, is controlled via terminal 15 on the Lambda Sond control unit under the rear seat. I found that by tapping the relay I could cut off power to the valve. After removing the relay cover and watching the contacts (with terminals 87 and 30 on the fuel pump relay jumped) I observed these contacts to open and close intermittently.

I cleaned the contacts with crocus cloth and slightly bent the stationary contacts to decrease the gap. After re-installing the "fixed" relay I have not experienced the engine hesitation problem. A local mechanic also mentioned that he has corrected similar problems by cleaning the ground connection for this relay which is located behind the right side of the radiator.

Other items of interest:

Hood Rub Guards--Earlier Newsletters mentioned having to drill holes to mount plastic rub guards on the hood and fender locations. I used 3M Emblem Adhesive and have had no problems with them coming off. I hate drilling holes and trying to rust-proof them.

Squeaks in the dash panel due to plastic-on plastic and plastic on vinyl can be effectively cured by using aerosol silicone lubricant and careful application with the plastic extension tube provided by the manufacturer.

I have mentioned on a couple occasions to the local dealer, the Saab Information Bulletins from Saab-Scania of America which appear in the Newsletter. The local dealer has been unaware of most of them. I don't believe the difference in US and Canadian cars accounts for this. Anybody have any ideas?

Ian G. Duthie, Calgary, Alberta

'79 900 HAS OVERHEATING, RUST PROBLEMS

I have a 1979 900 Turbo with two nagging problems. The first is that it heats up in traffic at the slightest delay (even a long red light). The radiator has been boiled, water pump replaced, and head gasket changed. I have fixed a small leak and it does run cooler in normal running. My next step is to change the sender switch on the radiator to get the fan (no AC) on sooner, I hope. Do they go bad? I just hope I don't warp that beautiful redone head before I fix the problem.

The second problem is rust--it is terrible. I bought the car used and do not know its whole history. There are repainted sections which are bubbling and I accept that as a used car risk. But I have bubbling under a lot of factory paint. For example rust in the rear window channel was the cause of my back window shattering. It is because of this rust that I've very reluctantly decided to sell the car--a sad decision. Does anybody else have bad factory paint/rust problems?

Andrew Spence, Hyde Park, NY

Ed. Note: Most of my chronic overheating problems in my '79 99 were cured when I got a new radiator core. Just cleaning the old core did not help as the fins between the tubes were rotted and did not transfer heat efficiently. Having the radiator boiled will clean deposits on the inside, but do little to fix corroded fins between the tubes. I also have a manual fan override switch which allows me to turn the radiator fan on early enough to keep cool in stop and go traffic. It does seem that the radiator fan thermostats gradually go on at ever higher temperatures as they get older.

HONDA MOTORCYCLE SHOP HAS 80 WT. GEAR OIL

I found out something the other day that might be helpful to owners of older Saabs. I went to the Honda motorcycle shop and found that they carry 80 wt. gear oil. It seems that the shaft drive on the Gold Wing uses it. As far as I can tell it was straight weight--the price was reasonable also.

Bob McNary, Ventura, CA

ARCHER RACING



SPOILERS

99 Front, List \$129

99 Sedan Rear, Trunk Lip, List \$129

900 Sedan Rear, Trunk Lip, List \$136

\$99 each

Plus \$6 Shipping

BOSCH FOG LIGHT KIT - includes 2 lights, grills, covers, switch, relay, & wiring.

ONLY \$59.50

Plus \$3 Shipping.

14" Leather Covered Steering Wheel. Includes Hub.

\$49.95 Plus \$3 Shipping





ARCHER RACING

MN Residents' add 6% sales tax.

326 E. CENTRAL ENTRANCE
DULUTH, MN 55811

(218) 727-1814



#3 Brickton Road, Rt. 4
Princeton, MN 55371
612-389-3776

Dear Saab Club Members:

We are pleased to announce the addition of Daryl Pfaff to our staff. He will be handling our parts department, so when you call, ask for parts or Daryl. Some of our specials for the period ending Sept. 15 include:

Turbo Oiler Kit (specifically designed for Saab Turbos. All lines are steel braid, and comes with complete instructions)-----	\$75.00
Valvoline Turbo oil, 15W40, by the quart-	\$1.49
New, genuine GM Air conditioning compressors, for '79-80 900, with clutch-----	\$250.00
Brake Rotor Kit--includes 2 rotors, full set of RGP dual compound pads:	
69-84 99/900 rear-----	\$59.99
69-80 99/900 front-----	\$59.99
81-84 900 front-----	\$99.95
Fuel injection nozzles - Bosch	
69-74 99-----	\$37.95
75-79 99/900-----	\$17.95
80-84 all 900-----	\$19.95

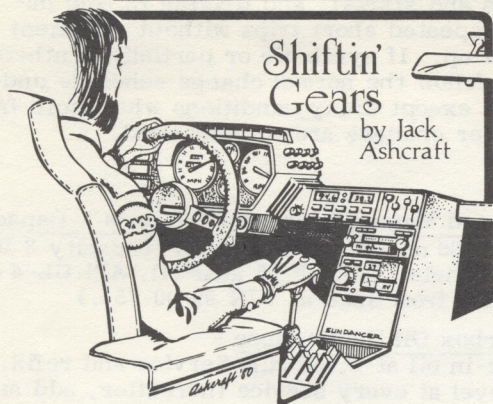

GETTING THE LEAD OUT

BIG HEADLINES recently: "EPA TO TAKE 91% OF THE LEAD OUT"..... Now I am all for having bureaucrats get the lead out but this pertains to gasoline and that affects most all of us old V4 pilots. Non-leaded gasoline makes a Saab V4 go through valves and valve seats (exhaust) faster than you can say "tetraethyl."

I have to admit being a closet environmentalist to some small degree and lead is bad for your system, no doubt about it. The EPA, however, has the bit in it's teeth and like most government operations, probably won't take any sort of sensible approach to the problem (like getting the price of unleaded and regular to the same figure so there is less incentive to cheat and use leaded fuel). We will be protected once again and once again we will take it right in the pocketbook.

BUT, at least the cars can be made to use the unleaded fuel and won't have to be scrapped in favor of a plastic econobox that costs ten grand. If you will refer to the May, 1981 issue of the Newsletter, you will find my article on converting the V4 to use unleaded fuel. Basically you need to replace the exhaust valves with V6 Mustang units and have hard valve seats put in as well. I used Allied brand parts:

Valve Seat, Allied # 218-7393
Exh Valve, Allied # 211-2169

When the valve guides get sloppy and finally have to be changed, have the machinist put in silicon bronze units and your Saab is ready for the unleaded go-juice.

V4 FLYWHEEL BOLTS

It seems that I spend quite a bit of my time trying to find lower cost (not cheaper) parts for Saab automobiles. A case in point is the flywheel bolts for the V4 engine. Ford/Saab tells us to torque these bolts to 50 ft lbs, which is a stretch torque figure, and then when we pull the bolts at some later date (as when we have to change a rear crankshaft seal or have the flywheel surfaced), we remove the bolts and throw them away. Good idea to discard them, because they will probably break the next time you use them since you already stretched them once, remember?

Saab charges around \$2 a bolt for these beauties and that means you get swacked for at least \$12 just for taking off the dumb flywheel! There must be a better way.

Some research at the local House of Henry produced a more palatable solution. The flywheel bolt used on the Ford Mustang V6 AND the Pinto just happen to be the same pitch thread and the same diameter (10 mm) and though they are a couple of mm longer, they work just fine and clear the input transmission shaft AND the clutch plate AND even hold the flywheel on good. You will have to use a 17mm socket instead of a 16mm socket to tighten them up. Use Saab's 50 ft lb torque figure, of course. Price? about 95¢ each, retail, a considerable saving over the cost of the Saab item. FoMoCo Part Number is D4FZ-6379-A.

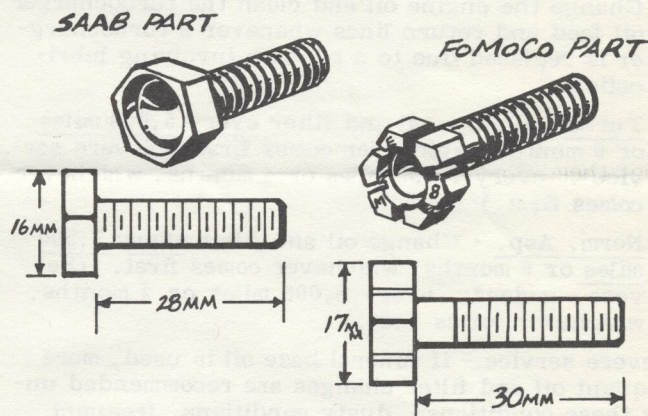

THE "BEST" MACHINE SHOP

Now, as always, there seems to be a lot of repair and machine shops that have their doors open and their hands out, but have a hard time producing a satisfactory product. They'll tell you they can't get good help these days. Bull. It's no harder to get good help than it ever was. Truth of the matter is, given the unemployment figures of today, it's probably easier than at a lot of other times in history.

Whether a shop produces good work or bad work is a direct reflection on the manager or owner. If he demands that the work be done right, it will be. If the work is consistently shoddy, you can bet your britches the boss either don't care or is willing to compromise to make a fast buck.

When I have work done on Saab V4 cylinder heads, I always try to find a shop that has a good reputation for working on Fords, and take the heads to them. If they can do it right on a 289, they can do it right on your little Ford heads as well.

SAAB SERVICE TIPS

CURRENT OIL RECOMMENDATIONS, ENG. & TRANS.

Saab Service Info 03/84-672:

Engine Oil Specifications (all 2.0 liter engines)--

Use only oils meeting SAE viscosity ratings and API Service Classes as approved below. Do not add separately packaged additives to the oil.

Viscosity: SAE 10W-30. (Alternates: SAE 5W-30, SAE 10W-40).

API Service: Turbo - SF/CD or SF/CC if available, or SF
Norm. Asp. - SF/CC if available, or SF

Engine Oil Capacity (including filter) -

Turbo: 4.5 U.S. qts. (incl. oil cooler)
Norm. Asp.: 4.0 U.S. qts.

Engine Oil Change Frequency -

1. Always change the engine oil as outlined below, regardless of whether the oil is mineral or synthetic-base or a blend of both.
2. Always change the oil filter when changing oil.
3. Change the engine oil and clean the turbocharger oil feed and return lines whenever a turbocharger is replaced due to a problem involving lubrication.

Turbo - Change oil and filter every 5,000 miles or 6 months, whichever comes first. (Severe service*: every 3,750 miles or 4 months, whichever comes first.)

Norm. Asp. - Change oil and filter every 7,500 miles or 6 months, whichever comes first. (Severe service*: every 5,000 miles or 4 months, whichever comes first.)

*Severe service - if mineral base oil is used, more frequent oil and filter changes are recommended under these conditions: dusty conditions, frequent trailer towing or mountain driving, extensive idling, stop-and-go driving (particularly with multiple daily

engine stops and starts), and driving in cold climates over repeated short trips without sufficient engine warm up. If synthetic or partially synthetic oil is used, follow the normal change schedule under all conditions except dusty conditions when more frequent oil filter changes are recommended.

Gearbox

4- and 5-Speed Manual Gearbox Oil Spec's & Capacity

Use SAE 10W-30 or 10W-40 engine oil (capacity 3 U.S. qts.). (Alternate: SAE EP 75 gear oil, API GL-4 or GL-5 available from Saab as P/N 99-00-754.)

Manual Gearbox Oil Maintenance -

Drain break-in oil at 1,000-Mile Service and refill. Check oil level at every service thereafter, add as necessary to top up.

3-Speed Automatic Oil Spec's & Capacity (all B-W Type 35 and 37) -

Transmission Fluid: Use only Ford type ATF, M2C33F or G (capacity 8.5 U.S. qts.). Do not use Suffix A or Dexron ATF's.

Differential Oil: SAE EP 80 gear oil, API GL-4 or GL-5 (capacity 1.3 U.S. qts.) (Ed. Note: See article elsewhere in this Newsletter for source of EP 80 oil.)

Automatic Gearbox Oil Maintenance -

Change differential oil at 1,000-Mile Service. Check transmission fluid and differential oil levels at every service thereafter, add as necessary to top up.

PRICE REDUCED ON SAAB FACTORY MANUALS

As your Editor's note pointed (June '84, p. 2) the Factory service manuals are an expensive alternative (to the Haynes 900 manual), however, they are not as expensive as they once were. This Spring we reduced our suggested list prices for complete service manuals to \$34.10 for the late 99 and \$86.10 for the 900 (3-volume set in binders). Individual soft cover sections of the 900 manual are available at modest cost (\$5-\$10 each). The engine electrical and body sections (Nos. 2, 3 and 8) are perhaps the most useful ones for the average enthusiast. Not all sections are updated every model year, but when they are, we usually put a special price on the old ones to sell off our stock over the winter. I will be happy to advise the club when such price reductions are announced.

Thank you for your continued support and enthusiasm for Saab.

Daniel L. David, Manager
Technical Services Department
National Service Division
Saab-Scania of America, Inc.

JULY 1984 SAAB SERVICE TIPS

During late M84 production (approx. June), a low pressure gas shock absorber made by Tokico was introduced on 900 base models. The shocks may be identified by their light brown paint coating and the name Tokico stamped on the side.

The next edition of the spare parts microfiche shall reflect this change but until then please note the following part numbers:

Front shock absorber (900) p/n 89-93-404
Rear shock absorber (900) p/n 89-93-412

SAAB PARTS SPECIALS!

CARTEL SILICONE BRAKE FLUID
8OZ \$5.25 / QT 15.40 / GAL 57.00

CASTROL LMA DOT 4 BRAKE FLUID
ATE/GIRLING APPROVED. 12 OZ \$ 3.00

BOSCH SPARK PLUGS W7D & W8D
75¢

SEMI-METALLIC BRAKE PADS
ALL MODELS \$18.95 PER SET (4)



(218) 727-7629

326 E. CENTRAL ENTRANCE DULUTH, MN. 55811

Continued on next page

SAAB SERVICE TIPS, JUNE 1984

Difficulty may be experienced when trying to unwind a retracted seat belt mechanism when it is out of the car. The seat belt assembly is designed to function only when held or mounted in the car at a prescribed angle.

When unwinding out of the car, duplicate the angle at which it would sit when mounted and slowly unwind the belt.

Evaporator insulation which has fallen off or been removed from the end of the evaporator will hinder the performance of the air conditioner and cause unnecessary cycling of the clutch, particularly in slow traffic. Underhood temperatures measured at the evaporator may reach 230°F when adequate insulation is not in place.

When replacing "tar strip" insulation, use only the types recommended for use in automotive applications and preferably a name brand such as Murray, ARA or Delco. Remove all remnants of the old insulation before applying new insulation and make sure the evaporator is dry.

M84 5-Speed models before VIN Serial NO. E1020500 and E2009400 may experience a problem with a faulty reverse light switch. In these cases the insulation on the switch may cause continued blowing of fuse no. 13 and erratic operation of the charge warning lights and the tachometer.

Improved switches (p/n 95-03-483) are on hand and should be used to repair the problem.

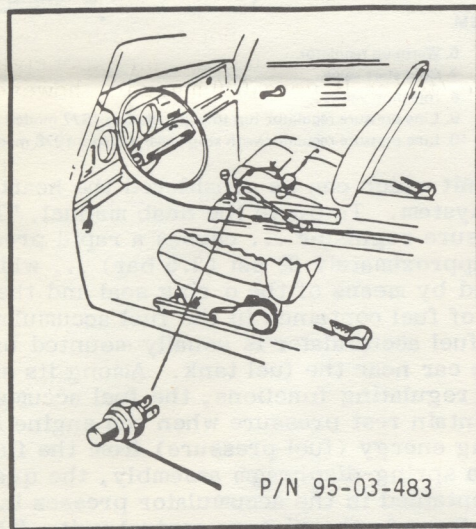

Two new radiators were recently introduced into production and into spare parts which supersede all other 900 radiators. The new radiators (Natur-

ally-aspirated p/n 75-41-063 and Turbo p/n 75-41-071) feature improved vibration insulation at the upper mounts and stronger soldered joints within the radiator.

Due to the improved insulation from vibration, a new mounting procedure is necessary and will be fully explained in an S.I. once the spare parts for the mounting kit (p/n 88-17-579) are available.

A recent S.I. was issued addressing the repair of water leakage into the passenger compartment of the car. S.I. 91/84-661 (Feb. '84 Newsletter, p. 6) describes the use of Strip-Calk as a means of sealing the two halves of the evaporator housing. We would like to remind you that Strip-Calk or an equivalent product is the only type of sealant other than some glues, which will adhere to the plastic of the evaporator housing. Silicone seal will not stick well enough to the housing.

Michelin tires were fitted to limited numbers of late 1984 cars as follows:

Michelin MXV 195/60 HR15 - M84 Turbo 3 dr.

Michelin MXL 185/65 TR15 - Other M84 models

These Michelin tires are equivalent to Pirelli P6 and P8 tires. Michelin will join Pirelli as a regular tire supplier for U.S. Saab variants from M85 production.

JULY SAAB SERVICE TIPS, continued

To reduce rattling of the rear passenger backrest, the seat locking bracket has been fitted with a teflon guard and foam rubber is now fitted under the hook. This was valid from VIN Serial Nos. E1034780 and E2016890.

On cars without the improved locking mechanism, washers may be used under the rubber stops for the rear backrest to reduce seat movement. Fitting washers (suggested size 12x6x2) pre-tensions the rear seat back, taking up the space that allows excess movement of the seat back.

You may add as many as two washers, depending on how much free play there was. More than 2 washers will stretch the limit of the rubber stop.

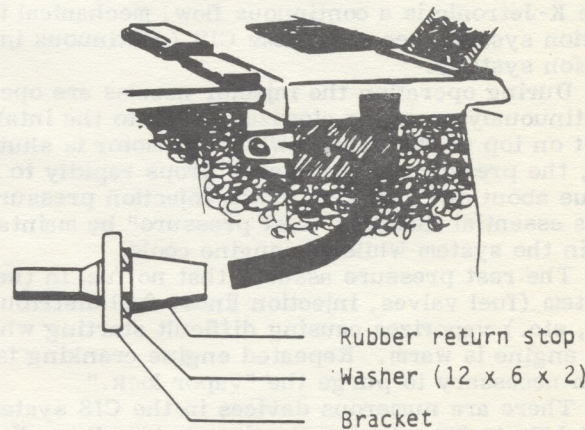

Washers are now being used under the license plate mounting screws to prevent the screws from being run in too far, damaging the paint finish under the mounting bracket. You will find that this was introduced from VIN Serial Nos. E1034153 and E20166-17 on 3-door models.

24-48 Hour Service

Your #1 Source for O.E.M. SAAB Parts in Wisconsin

Out of State Call Collect (414) 771-2340

1-800-242-2003

Parts Open Saturday 9-1 p.m. Volvo • SAAB • Subaru • Triumph

tosa imports
6102 W. North Avenue
Milwaukee, Wisconsin 53213

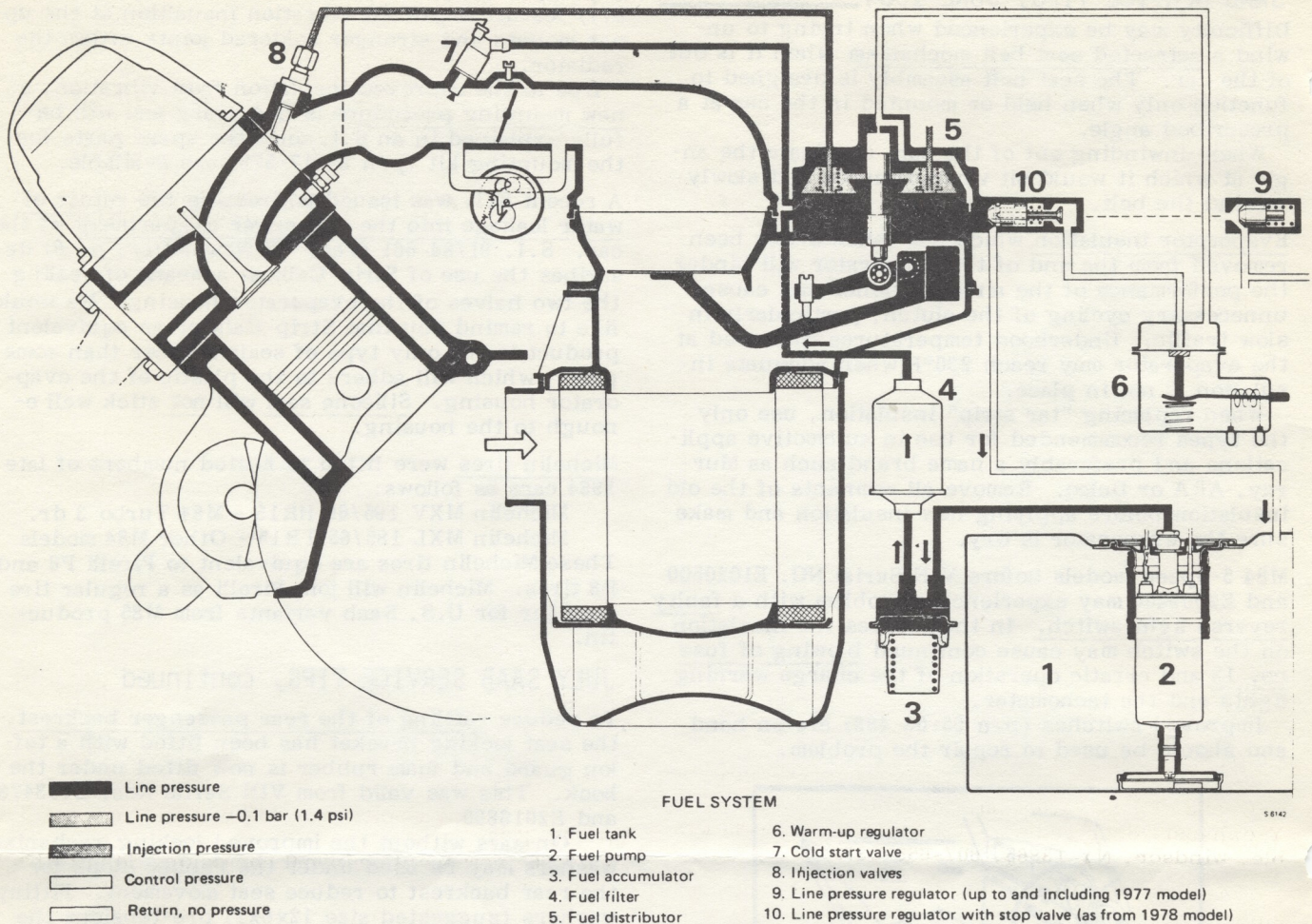

HOT START PROBLEMS IN THE BOSCH CIS SYSTEM

by John P. Barron

The Bosch K-Jetronic fuel injection system was designed to provide smooth performance together with good fuel economy and low exhaust emissions. The K-Jetronic is a continuous flow, mechanical injection system, hence the name CIS (continuous injection system).

During operation the injector nozzles are open continuously spraying atomized fuel into the intake port on top of the valve. When the motor is shut off, the pressure in the system drops rapidly to a value about one-half that of the injection pressure. It is essential that this "rest pressure" be maintained in the system while the engine cools.

The rest pressure assures that no fuel in the system (fuel valves, injection lines, fuel distributor, etc.) vaporizes causing difficult starting when the engine is warm. Repeated engine cranking is then necessary to purge the "vapor lock."

There are numerous devices in the CIS system that help to insure easy starting under all conditions. The fuel injector valves are set to open at a pressure slightly below the injection pressure. If the pressure at the injector falls below this level (i.e. when the motor is switched off) a spring-pin assembly closes the valve, stopping the spray of fuel. A tight injection valve insures that there will be no leakdown of rest pressure here.

The line pressure regulator (primary circuit pressure regulator) is mounted in the fuel distributor. The fuel distributor is part of the mixture

control unit which can be considered the heart of the CIS system. To quote the Saab manual, "The line pressure regulator ... causes a rapid pressure drop to approximately 35 psi (2.5 bar) ... which is maintained by means of the o-ring seal and the quantity of fuel contained in the fuel accumulator."

The fuel accumulator is usually mounted underneath the car near the fuel tank. Among its several pressure regulating functions, the fuel accumulator helps maintain rest pressure when the engine stops. By storing energy (fuel pressure) from the fuel pump in a spring-diaphragm assembly, the quantity of fuel contained in the accumulator presses in one direction towards the mixture control unit. The fuel in the accumulator is kept from flowing back towards the fuel pump by a simple check valve located in the fuel pump.

Lastly, perfect operation of the fuel pump is essential in delivering the fuel, under the correct high pressure, to the system.

Through my experience I've learned that there are numerous factors involved in the proper operation of the Bosch CIS System. If any of the devices described above should fail, it could lead to vapor lock with consequent difficulty in restarting the warm engine. In the diagnosis and alleviation of hot start problems in the K-Jetronic system, it takes some tools (especially a pressure gauge), skill and above all patience to make necessary repairs and once again restore quick engine starting.

John P. Barron, St. Louis Park, MN

PARTS MART



CLASSIFIED AD RATES

Ads offering parts or Saabs for sale or wanted at prices under \$200 are FREE to members and non-members. 25-word limit, plus name and address. Ads listing prices of \$201 to \$900, enclose \$2. Ads listing prices \$901 to \$2000, enclose \$5. \$2001 and up, enclose \$10. All ads without a price listed, enclose \$10.

Commercial ads: contact Editor for rates and info. We will delete all unnecessary superlatives and abbreviate where possible. Please enclose sufficient funds with ad copy; we will not bill.

CLASSIFIED AD DEADLINE

The Classified Ad deadline for the September issue will be Sept. 4th and the deadline for the Oct. Newsletter will be October 1st.

SONETTS FOR SALE

1972 Sonett III, 63,000 mi., orange, Michelins, Mags Y-exhaust, Saab radio: \$2195 or offers? Norm Dible, Windsor, NY 13865, 607-655-2371

1972 Sonett III, 91K mi., 22K mi. on rebld eng. & clutch, have some new & old spare parts, with manuals: \$1700 obo. Daniel Frutiger, 73 Lantana Way, Laurence Hbr, NJ 08879, H 201-583-0178, W 201-474-7051.

1972 Sonett III, red w/ black trim; new clutch & press. plate, new front tires, very good cond. through out, 56,000 mi. L. Dawson, Elmhurst, IL 312-530-1311

1973 Sonett III, good condition--needs some work: \$1950. Mark Fuhrmann, 6501 Potomac Ave, Alexandria, VA 22307, 703-768-2480.

1973 Sonett III, 63,000 mi., yellow new paint, new MSS exh., excel. in and out, complete restoration: \$3500. Ken Dressler, S4W32970 Government Hill Rd, Delafield, WI 53018, 414-646-8718.

1974 Sonett III, #2033, 24,000 mi., looks and drives excel., int. like new. Pictures avail. Delivery negotiable. Doug Whisler, 1208 E. 27th, Hutchinson, KS 67502, 316-663-8959

1974 Sonett, SCCA race prepared, fresh engine, excel. cond.: \$2850, street equip. avail.; '70 & '74 Sonetts, easy restoration projects, all parts provided, no major rust or body damage: \$1050 and \$1250. Randy Cook, Lawrenceville, GA 404-962-0528.

95's and 96's FOR SALE

1963 GT850 sedan, 2 stroke, 3 carb, oil-injected, "bullnose" type, wood & aluminum steering wheel, gauges, front discs: \$600. Ed Moehagen, 108 Bridgewater, Chippewa Falls, WI 54729, 715-726-1924

95's and 96's FOR SALE, continued

1967 96, good paint, no rust, 30,000 on eng. & trans. fresh hydraulics & exh., 3 carb: \$600. Clayton Culver, 67 River Rd, Flanders, NJ 07836, 201-927-9062 Home, 212-741-5781 work.

1967 95 wagon, 3 cyl, body solid, engine dead(?): \$175/b.o. or trade for alloy wheels for '80 900. Dave Nichols, 3017 Oxbow Rd, Evergreen, CO 80439, 303-985-3332, or 674-0159.

1968 96 V-4, disassembled, rebld eng. & trans, some extras: \$800. Tom Smith, Box 931, Eureka, CA 95501, 707-822-6167 eve's & weekends.

1970 96, 103,000 mi., no rust, no dents, exc. int. and mechanical cond., new tires, looks & runs like new: \$3950. H.A. Thorpe, 712-328-0221.

1971 95 wagon, eng. & trans. rebld 5,000 mi. ago, clean int., new carb, clutch & CV joints; body & trans. need some work: \$600. Charles Young, 750 Edmonds St, Edmonds, WA 98020, Wk 206-774-4124, H 775-4727.

1972 96, new paint, minimal corrosion, Sonett wheels Cibie headlamps, Koni's on front, fog lights, Clarion sound sys., new Die Hard, asking \$1750. Bill Littlefield, 96 N. Main St., E. Longmeadow, MA telephone # from direc. assis.

1972 96, tan color, v. good body, exc. int. & seats, newly reworked trans, brakes & eng., less than 75,000 mi., orig. owner. asking \$4000. Elizabeth Furrey, 230 Stuckhardt Rd, Trotwood, OH 45426, 513-837-1043.

1973 95, blue, 120K mi., repainted 2 yrs ago, working freewheel, new brakes, runs great: \$1200 negotiable, owned by Saab certified technician; C. Smart 814-364-9426 after 8 pm EDT

95, 96, & SONETT PARTS FOR SALE

Sonett III parts--have parted out five Sonetts, all type parts available, reasonable prices, send SASE for list of major parts, or write with specific need. R. Cook, 1877 Oak Ridge Ln, Lawrenceville, GA 30245.

Parting out '68 96 Deluxe, many good parts, cheap, also several 2 barrell carbs (Weber, Solex) Send SASE to Bernie Wassertzug, 11825 Enid Dr, Potomac MD 20854.

Sonett V-4 air cleaner ass'y: \$20; V-4 radiator: \$75 V-4 tach: \$45; 2-stroke, bulb-type temp gauge: \$25 95 tail-light ass'ys & lenses: \$15; Many other 95/96 parts, new & used. Quantum Mechanics, 45 Hunting-ton Ave, S. Yarmouth, MA 02664, 617-394-5193.

Classified Ads continued on next page.....

95, 96, and SONETT PARTS FOR SALE, cont'd

1967 3 cyl. eng. & trans. complete; 3 cyl. tach, crank parts & tools & other misc: \$400. Dwayne Nelson, Rupert, ID, 208-436-6859.

Web-cased transmission from '72 V-4, exc. cond.: \$200; '68 V-4 radiator: \$35; '70 96 windshield: \$35. many other 95, 96 & Sonett parts. Nick Hayden, 3385 W. 86th, Cleveland, OH 44102, 216-281-9823 or 431-9413.

Sonett speedo cable (new) \$30; front muffler for 3 cyl. (new) \$45; trailer hitch: \$7.50; 3 cyl. gas caps: \$5; 3 cyl. air filter: \$10. Mark Zenick, RD#1 Baptist Corner, Shelburne Falls, MA 01370, 413-625-9235.

1700 V-4 motor, disassembled, all good, needs new rings, have new brgs & gaskets, best offer over \$75; Many 96 body panels, hoods, doors, trunks, glass, etc, no reasonable offer refused; V-4 starters, & alternators, Cheap. Scott Anderson, 411 W. Birch #2, Flagstaff, AZ 86001, 602-779-0561.

95, 96, & SONETT WANTEDS

Wanted: trailer hitch for 95 wagon, preferably original 3-point mount: \$25 + ship. or ?. Erick Killinger, PO Box 283, Boulder, CO 80306

Wanted: for '74 Sonett; front bumper & mounting brackets, grille, pass. side door lock rod, seat belt harness, outside mirror, gas pedal w/ hinge. Ron Canaday, 720-G N. 63rd, K.C., KS 66102, 913-299-4751 M-Th, 816-264-3973 Fri-Sun.

Wanted: 1967068 Saab Monte Carlo, looking for rust free original in very good shape. Jim Voikos, Box 61, Port Huron, MI 48060. Will travel for right car.

Wanted: Dual pulley for V-4 air conditioning, will pay reasonable price (\$10?) & shipping. Mike Linnartz, PO Box 06357, Columbus, OH 43206, 614-469-1995 weekends.

99's and 900's FOR SALE

1973 99LE 2 dr, injected, body bad, trans. shot, strong eng. (20,000 mi. on rbl'd) new exhaust: asking \$195. John Jan, Pittsburgh, PA, 412-393-5559 office, 881-5558 after 6:30 pm

1979 900 Turbo, exc. cond., 60,000 mi., maroon, AC New Michelin tires, new turbo 5,000 mi. ago, sun-roof, complete set fact. manuals: \$6495, Mark Brenny, Bettendorf, IA, 319-359-7222 Wk, 332-7433 H.

1980 Turbo, 5 dr, 5 spd., high mileage, but all major componenets replaced, incl. turbo, head, manifold, timing chain & AC compress.: \$5,500. Paul Niedringhaus, 1805 Sunset Ridge Rd, Northbrook, IL 60062, 312-446-3606.

99 & 900 PARTS FOR SALE

New 2.0L cyl. head: \$600; 1.85 cyl. head, new spgs & guides: \$200; late 99 2 piece exh. manifold: \$75 99 LCA re-inforced: \$55 ea; used 99 trans. 73-74: \$250; '76 grille: \$45; early 99 EFI pumps: \$15; 900 dashboard: \$125. Quantum Mechanics, 45 Huntington Ave, So. Yarmouth, MA 02664, 617-394-5193.

99 and 900 PARTS FOR SALE, continued

Original factory shop manual for 79-80 900 & Turbo: \$60; Back issues of Club Newsletter, Mar '81 to present: \$2 w/manuals, \$5 spearate. B.A. Brown, 1773 Hampton Knoll Dr, Akron, OH 44313, 216-923-9283.

'79 99 exh. manifold, will fit all 2.0L: \$50; KYB gas shocks for 99's & 900's: \$24 ea. Jeff Delahorne, 5805 Oneida St, Duluth, MN 55804, 218-525-3253.

Under dash radio box from '76 99, no AC: \$10. Geo. Elias, S.R. #59, Grahamsville, NY 12740, 914-985-7274

Four '84 Turbo wheels, complete w/ lug nuts, center caps & valves stems, new take offs: \$250. C. Smart, 814-364-9426.

Four stock wheels from '80 99GLE; all in exc. cond. & true, no dings or rust: \$50 for set. G. Dudley Johnson, 5715 Killarney Ave, Ft. Pierce, FL 33451, 305-461-5879.

Four Saab TRX wheels w/ five TRX tires, incl. locks lugs & center caps, v.g. cond.: \$300; Also '79-82 front bumper skin, fair: \$25; stock front valence/spoiler: \$25; 4 good Bilstein gas shocks: \$50; all plus UPS. Tim Middleton, 2410 Cambridge, Columbus, OH 43221, 614-488-5820

99 Parts: rbl't auto trans. 74-80: \$400; rbl't manual trans. '75-80: \$375; fuel pump CIS: \$45; wiper mtr: \$40; RF pkg light '78-80: \$40; rear t'lights, lge: \$40 adar detec., Fuzzbuster: \$35; Escort: \$175; Wanted power steering pump '76-77 99. Vic Pardo, 3715 Pleasant Grove Rd, Lansing, MI 48910, 393-2766.

Right front turn sig. lens ('78 99L): \$10; steering wheel w/ horn button: \$10; '78 fact. shop manual: \$20, plus postage. Larry Bean, 2873 Grosvenor Dr. Cincinnati, OH 45239.

Haynes 99 Workshop manual, never used: \$7. Lee Birch, 346 Canyon Vista Dr, Los Angeles, CA 90065

Driver-Ed your 900; Complete set of dual clutch and brake pedals for any 900. Saab original parts; used 3 years in our driver-ed program: \$85 UPS incl. Jim Malin, Clews Saab, 215-644-5054.

Official Saab 99 repair manual, incl. all models thru '74, exc. cond.: \$25 incl. ship. Richard Bohn, 603-881-3077, Nashua, NH

99 and 900 WANTEDS

Wanted: 2 rear headrests w/ cushion & upholstery (prefer burgundy); One driveplate (flywheel) for auto. trans only, must be in good cond.: one trailer hitch for 99 5 door; For sale: 2 front headrests (blue lining) absolutely new: \$25 for both. Joel R. Soumagne, 785 Vimy St., Sherbrooke, Que J1J 3N8 Canada.

Wanted: late model ('77-80) 99 front turn sig. ass'y w/lens, will pay reasonable price plus ship. Mike Linnartz, PO Box 06357, Columbus, OH 43206, 614-469-1995 weekends.

Wanted: for '76 99EMS, driver's seat rubber support will pay app. \$10 plus post. Phil Grayton, 94 Poplar St, Danvers, MA 01923, 617-774-0246.

SVEN'S NEW, IMPROVED 2-STROKE TIPS

SAAB'S PLANES #8
SAAB J35 'DRAVEN' (DRAGON)
1957
WEIRD 'DOUBLE DELTA' PLANFORM. 1ST SUPER-SOON SAAB

THANK YOU, THANK YOU - NOW FOR MY "BROKEN CONNECTING ROD" IMPRESSION, THEN I'LL DO A "CRACKED PISTON" -

OLD 2-STROKES ARE GREAT MIMICS!
OFTEN THOSE DEADLY-SOUNDING NOISES ARE NOT WHAT YOU THINK! THERE ARE SEVERAL COMMON SOURCES OF NOISE ON PRE-64 2-STROKE ENGINES THAT ARE EASY TO FIX! IF YOUR ANCIENT OIL BURNER MAKES NOISE, LOOK AT THESE 5 PLACES FIRST!!

MANY THANKS
TO THOSE CLUBMEMBERS WHO WROTE IN DURING MY ABSENCE!
KEEP THOSE CARDS N' LETTERS COMIN' TO:
'SVEN' Box 56
FAYETTEVILLE, ARK.
72702
SINCERELY
Luck
6-27-84

APPLIES ONLY TO PRE-64 2 STROKES

- FAN GUARD GETS LOOSE, HITS FAN, SOUNDS LIKE BAD ROD BEARING.
- FAN SHAFT BEARINGS WEAR OUT, GET NOISY
- FAN PULLEY BOLT GETS LOOSE, RATTLES
- DISTRIB. DRIVE GEAR GETS DRY-GREASE WIZIK ON LEFT SIDE BEHIND PULLEY
- FANSHAFT MOUNT BOLTS GET LOOSE, CLATTER

VALVE CLATTER

by Jeff Delahorne

I am pleased to announce the return of "Sven's New Improved 2-Stroke Tips" to the Newsletter. Tuck Boys has been busy establishing a new business, and had to take a leave of absence from doing the Sven's strip for a while. I'm glad to see him back in the world of Saabs.

Membership--Last month we mailed a total of 3211 Newsletters. California is still the state with the most members, but lately we are getting a lot of new members from New York, New Jersey, and Pennsylvania. We are also now sending 125 Newsletters to the Saab Owners' Club in Toronto, as well as ones to Great Britain, Norway, Sweden, Israel, Australia, New Zealand, and Guatemala.

Rallying--The four Saab entrants at the Arkansas Traveler PRO Rally July 28 in Little Rock did not do so well. Tom French's 99 Turbo suffered problems from overheating and he dropped out after the first stage. The gearbox on my 99 broke in stage 2 for its first DNF. Club member Ken Payne experienced fuel injection problems and was not able to start the third stage--this after having driven his rally car all the way from North Carolina. However, Buzz Gorski and co-driver Francis Nowak soldiered on in their '79 99 to finish seventh overall and second in Seed Two.

LOKI
AUTOMOTIVE

ROUTE 1, BOX 19D
RUCKERSVILLE, VA. 22968

SAAB PARTS & SERVICE
New & Used Parts at Reasonable Prices
TRANSMISSION & ENGINE REBUILDS
Our Specialty
804-985-7924, Mon-Fri 8:00-6:00
Visa/Master Card

SAAB 900
AUTOMOBILES

TURBOS, 1981-ON, INCLUDING APC:
Water injection kit increases 25hp at the touch of a button. The Safety for Easy Overtaking!!

3 DOOR, ALL MODELS: Customized with fender flares, side skirts, double size rear spoiler.

FRONT GRILLE FOR ALL 900's
Brochure \$2.00
Send Self-Addressed Stamped Envelope

CARTINA, INC.
Dept. SC, 5220 N.W. 72 Ave, Bay 35
Miami, Florida 33166

JPB
NEW! racing

HAYNES Workshop Manual
#980 SAAB 99&900 '79-'83
(inc. Turbo) IN STOCK!
\$12.95 Delivered MN Res. add 6%

2017 Virginia Avenue South, Minneapolis MN 55426

SAAB 895

SOLID BRASS KEY TAG ■ SHIPPING INCLUDED
ACID-ETCHED ENAMEL LOGO ■ CHECK OR MONEY ORDER
GIFT-PACKED CAN BE ENGRAVED
Clews & Strawbridge, Dept. K, 310 Lancaster Pike, Frazer, Pa. 19355

Please use knife/letter opener

AUGUST 1984

FIRST CLASS

RETURN POSTAGE GUARANTEED

c/o Jeff Delaborne
5805 Onida Street
Duluth, MN 55804



FIRST-CLASS MAIL
U.S. POSTAGE
PAID 20¢
PERMIT No. 1909

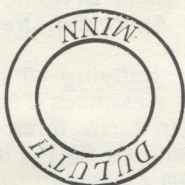

SAAB



VICTOR

Exclusively since 1958

SALES - SERVICE - PARTS & ACCESSORIES

Wholesale & Retail - UPS Daily Shipments

1125-35 Easton Road, Abington, Penna. (215) 886-8660

AMSOIL meets the challenge presented by turbocharged engines! Free information on the new 10W-30 TurboCharge Synthetic Motor Oil. Contact Wendell Emery, 1751 Pinta Drive, Holland, MI 49423

A NEW IDEA IN FIRE SAFETY

Auto-Home-Camper-Kitchen-Workshop



- STOPS FIRES INSTANTLY
- ABSOLUTELY NO RESIDUE
- NO DAMAGE TO EQUIPMENT
- REUSABLE WITHOUT REFILL
- LIGHTWEIGHT - ECONOMICAL
- 10 YEAR SHELF LIFE
- FOR A, B, OR C CLASS FIRES
- SIMPLE AND EASY TO USE

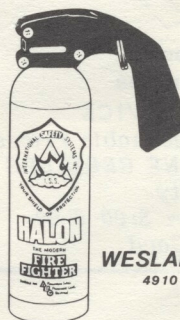

24oz HALON FIRE FIGHTER - COMPLETE WITH METAL MOUNTING BRACKET ONLY \$28.60 WE PAY FREIGHT WITHIN THE CONTINENTAL UNITED STATES.

NOW AVAILABLE FROM
WESLAKE MOTORING ACCESSORIES
4910 ST. ELMO AVE. BETHESDA, MD 20814
301-951-6363

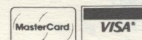

PERSONAL CHECKS ACCEPTED.
COD ORDERS PLEASE ADD ADDITIONAL \$1.65.