



# THE SAAB CLUB

NOVEMBER/DECEMBER 1983, NEWSLETTER #121

**GREATER NEW YORK SAAB CLUB**--next meeting will be December 18, Sunday, at 10:30 am at Flyod Bennett Field, Building 272. The topic will be steering systems. The first meeting in 1984 will be January 15, Sunday, 10:30am, same location, with the topic electrical systems. For more information, contact Marc Frank, 212-438-2022.

**CENTRAL WASHINGTON SAAB CLUB**--will have a winter meeting and rally, Sunday Jan. 15, 1984. For more information: Bob Eddy--206-486-9257 (Seattle) Shawn Irelan--509-548-7279 (Wenatchee), and John Baird 509-653-2067 (Yakima). Details will depend on weather--call after Jan. 1. As always, all interested Saab people and friends are welcome.

**SAAB CLUB OF SOUTHERN CALIFORNIA**--will have a semi-important monthly meeting, Dec. 6. To make enough interest to have a meeting we need warm bodies and hot cars--Saabs that is. Parking lot meeting begins at 7pm, indoors at 8pm at Antique & Classic, 1815 Mt. Baldy Circle, Fountain Valley. Food and drinks (wine & beer, etc.) available at reasonable rates. For further information, call Paul Florance at 213-438-3257.

**CENTRAL ILLIANA SAAB CLUB**-- will not meet in December or January. Next meeting will be March 25, 1984, 2 pm at 404 W. Green, Urbana. Saab-Scania's Service Training Manager, Fred Sanders, will be present with films and much knowledge. For more info, call Margrit Adler, 217-356-9244.

**NEW ENGLAND SONETT CLUB**-- next meeting will be on Saturday, Dec. 3 at the Gregg House Restaurant in Londonderry NH from 1pm to 4pm. The topic will be turbocharging a Sonett. Reservations requested: contact NESCC, Box 4362, Manchester, NH 03108.

**MILWAUKEE SAAB CLUB**-- will have their annual Christmas meeting in the Sternwirt at the Pabst Brewery on Wednesday, Dec. 28 at 7 pm. The Sternwirt is located at 915 W. Juneau Ave. Parking is available in the Pabst visitors lot across the street. All area Saab enthusiasts are invited to attend.

The Third Annual Ice Race is tentatively scheduled for Sunday, Jan. 29 at Lake Keesus, WI. For more information, call 414-964-7463.

## JACK LAWRENCE WINS SCCA CHAMPIONSHIP

Jack Lawrence of Jamestown, NY, put on one of the most exciting race performances at the recent SCCA National Runoffs at Road Atlanta, GA, when he completed a 45-mile seesaw battle by slipping his Saab Sonett by the MG Midget of Bob Criss in the last corner.

Lawrence thus capped a perfect season in the F-Production Class, having won all six races during the year to earn a trip to the annual fall championships. Criss led throughout much of the race, being hounded by Lawrence's '73 Sonett, until the MG driver made a mistake in the final turn and the Saab drafted by to win by .582 seconds.

Ola Stromberg Wins Two Swedish Championships--Meanwhile, in Sweden, Saab Turbo driver Ola Stromberg, driving for the Saab Sport & Rally Team, sponsored by Swedish Saab dealers, clinched the Group A titles in both rallying and hillclimbing.

Despite the fact that many newer cars are being entered in today's rallying, said Stromberg, the 220-horsepower Saab 99 Turbo has proven to be both faster and more reliable than the competition, in both rallying and hillclimbing.



*Erik Zenz and his co-driver David Stone slide their Saab 99 around a tight corner on their way to finishing second in Production Class at the Press On Regardless PRO Rally Nov. 4-6. (Photo by Rick Corwine)*

Saab Clubs of North America

Editor and publisher: Jeff Delahorne, 5805 Oneida St., Duluth, MN 55804  
(218) 525-3253 9 a.m.-8 p.m. except Sunday

Consultants: Dick Grossman, Jack Ashcraft, Carolanne Curtis, Andy Buc, Ted Tucker

# VALVE CLATTER

by Jeff Delahorne

Welcome aboard to those new members who joined by responding to ads in Road & Track and Car & Driver for a Saab Club of America in Baldwin, NY. The fellow who placed those ads, Frank Bruno, did not realize there was a national Saab Club, and thinking that there ought to be one, he decided to start one up. But, after placing the ads, he found out about our 10-year old organization, and decided that rather than competing to no purpose, he would join forces.

So to those who sent in \$20 for a one year membership, we have given them a one year subscription/membership, as well as our collection of back issues, which together we value at \$20. Many more people responded to the ads by sending \$1.00 for an "enrollment package." To those folks we sent a sample newsletter with an explanatory letter and hopes that they would also join. Some of our present members also responded and sent \$1.00, and for those we added extra time to their present membership.

This extra load of mail, however, has put Carolanne and me far in arrears in sending out binders and new member packets. Those of you who are awaiting these materials have shown great patience, and by the time you receive this we will be caught up.

**Reprints:** Since all of 1980 and much of 1981 Newsletters are now out of print, it seems like it is time to consolidate the best articles from those years along with 1979 as well, into a reprint. This is a more efficient way of handling the valuable information in those issues, than by reprinting each issue in its entirety. An edited reprint avoids the waste of reproducing want ads, club news, etc., which are time dependent and of little value after several years have past. Hopefully in our month "off" we will be able to put reprints together for 95/96/97 and 99/900. Look for news in the January Newsletter.

**Computer:** Many members I've talked to on the phone were curious about how the Epson QX-10 computer is working out. The answer, in a word, is

fantastic. What had been two days worth of work to do renewals for the month is now two hours work. Changes of address are even easier, and we've been able to make changes from notices we receive right up to the day we mail. What we do need from you when you change your address, however, is your old zip code. The mailing list is maintained using zip codes as a sort of "key number" and if you send us a post card saying "my new address is..." it will take us just as long as in pre-computer times to find where you were. Those change of address cards the

Post Office has are very nice. By the way, you do not need to peel off an address label when you renew or change addresses. It doesn't hurt, as long as you don't mutilate your Newsletter doing it, but the zip code is all we really need.

## SUNBELT SAAB TROUBLED WITH FADING PAINT

We have a 1981 900S in indigo blue and we have had problems with fading on the horizontal surfaces, especially the hood and thr roof. This is despite washing the car frequently, waxing it at four month intervals, and trying a variety of waxes and sealers.

Have any other sunbelt Saab owners had problems with this or other colors? Do any products work better than others?

I have been disappointed with the Bosch replacement wipers. Rain-X improves performance greatly, but I still get smearing. Any suggestions?

Don Shobrys, Houston, TX

## SAAB

### Parts & Accessories



**Factory Original Wheels**  
Set of 4 \$500.

**Autobahn Floor Mats**  
Four piece set—Custom Cut  
Sisal \$40.99 Plush \$51.10  
Call for Swatches

**900/Rally European Headlites In Stock!**  
Fully Illustrated, 32-Page Catalog of  
Discounted Parts and Accessories. **Only \$3**

**800-523-7011**

**EMS AUTÖSCANDIA**  
products inc.

340 E. Church Rd., King of Prussia, PA 19046    IN PA. (215) 277-2250

Dear Saab Clubbers,

Thanks for the great response to our parts ads of the last couple of months. The more parts volume that we have, the lower the price to you. We are frantically trying to get our computer loaded and keep our orders current. Please write or call for any 99/900 parts needs. Phone or mail orders will be answered as soon as possible. All prices advertised are everyday prices! All prices plus shipping.

- 99/900 T.mufflers 35.00
- Interpipe 7.50
- 99/900 Balljoints 14.50
- Bosch ignition points to 1977 3.00
- Dana cruise control 89.95

  
 # 3 Brickton Road  
 Route 4  
 Princeton, MN 55371  
 (612) 389-3776

## MEMBERSHIP/SUBSCRIPTION

Dues for membership/subscription are as follows:

- First year, third-class mail . . . . . \$11.00
- First year, first-class . . . . . \$12.00
- Renewal, third-class . . . . . \$ 8.00
- Renewal, first-class . . . . . \$ 9.00

First-year membership includes two back-issue newsletters, Club tech sheets and emblem. Renewal notification will be stamped on the open rectangle at the top of this page. A treasurer's report will be made three times a year. This is a nonprofit organization.

A collection of 15+ back issues with Club tech sheets punched for your 3-ring binder is available for \$8.00 postpaid. Individual back issues: 75¢ each.

Always specify: 96, 97, or 99/900 for appropriate tech sheets.

## PETER McLAUGHLIN'S BODYWORK PRIMER, PART 2

*Ed. Note: This is the conclusion of the article started last month on do-it-yourself bodywork for 95's and 96's, but much of the information should be applicable to 99's as well.*

First, a note about handling body parts off the car. Handle all body parts as if they just had a fresh coat of paint on them, even if they look ragged. Every scratch, ding and nick you impart to them at this stage will cause you more work later on. If you buy parts at a junk yard or dealer, transport them carefully and by all means wrap them in blankets or tarps.

**Doors:** Since you've removed your entire interior, you have a good idea of the condition of your doors. If they have any rust at the bottom seam or around the body side moulding trim holes, I found it easier to work on them in my basement than in my cold garage. That dingy-looking tar paper that overlaps the cut-outs on the inside of the doors is very important stuff. Remove it gently, trying not to tear it. Put it aside and lay it flat, because later you want to reattach it with contact cement in exactly the same manner as you saw it before you took it off.

I discovered the purpose of this paper when I sat out a torrential rain storm in the car. Even though I had put brand new rubber window trim on the doors, an amazing amount of water still poured down into the doors. Without the interior in place, I was able to see all the water drip through those cut-outs onto the floor. If you don't replace the tar paper before the interior goes back on, the interior masonite will sag and distort due to water damage.

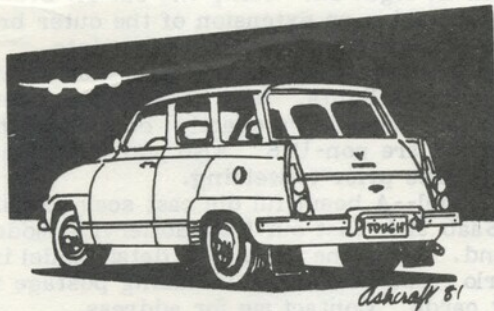

Every 96 I've ever owned suffered from rust blossoming around the holes where the body side moulding is anchored. I've noted in the 900 sales brochures they've eliminated all such holes for that very reason. You can do the same for your 96. After sand blasting all the rust around the holes inside and out, I patched them from the inside with one-inch squares of fiberglass, then bondo-ed and sanded the outside. Presto, no more holes. My new moulding is a very-near-to-original match I found at the automobile paint store. It is of the self adhesive variety, and must be applied while the metal is warm. If it is winter, use a blow dryer to heat the metal to a summertime temperature. I waited eight weeks after paint time and installed it just prior to doing the first wax job. If your outer door skin has separated from the bottom of the door frame due to rust, a good Saab body man can reskin the door for you. Perhaps the new skin wouldn't have the holes

in it, since different years had different styles of moulding?

The bottom of one of my doors was pretty rusty, but hadn't yet gotten to the point of separating from the door. I sandblasted everything in sight and then fiberglassed the seam where the bottom of the door skin folds over the door frame. I liberally poured extra fiberglass resin in the remaining cavities, (with the door laying face down on the workbench), hoping to create a "fly in aspic" effect.

Paint the inside of the door with some kind of rust treatment paint. Neatness doesn't count here. Finish with a coat of enamel. You should remove all door handle, lock mechanism, and window crank mechanisms. NOT only will it make your job easier, but all the attendant sand, dirt and grit from the cleaning and bodywork won't cause you headaches later on. When I reattached the doors to the car, I inserted a wire coat hanger through each door hole and looped an end through the screw hole where the inside door knob is usually attached. That way the paint shop got paint under my door handles, which should actually be your object with all exterior trim, rubber mouldings, etc. More on that later.

A general note when working with metal. Once you have removed paint from it by whatever means, bondo and/or prime it immediately, otherwise in a day or two it will begin to rust again from the humidity in the air. There is a metal etching acid you can get from auto paint stores that will help paint stick to the metal and will kill whatever tiny bit of rust you may have missed. Wear good rubber gloves.

**Sandblasting:** If you have an air compressor at your disposal, you can pick up an el-cheapo sand blaster for between \$50-100. J.C. Whitney has several models for sale. I used a fine silica sand, like you see in ash trays. Wear a mask and full face shield, long sleeves, gloves, a hat, etc. It's nasty work, but you can actually clean rust out of the inside of rust pits, something which not amount of wire brushing seems to accomplish.

**Removing trim:** Both in working on the body of the car and prepping it for the paint shop, you are going to want to remove all the trim, gaskets and emblems from the car. I did talk Maaco into painting the grill piece off of the car. It covers up so much adjacent bodywork that I wanted the fronts of my fenders, etc., to get paint on them. You took off your directional lights and back up lights to work on the fenders, so leave them off for the paint shop. The little round plastic "SAAB" logos on the side vents come off by removing the vents themselves. Besides the one visible #2 pozi screw, there are two #1 pozi screws hiding under the rear window gasket. The spring clips that hold these and most other badges are removed by gently squeezing the clip the long way with a pair of pliers until the hole gets a little relaxed, then pull the badge off.

I noticed that on the inside of the trunk lid that under the little badge clips were some foam washers which seemed to have trapped water and caused rust. After the first wax job (eight weeks after painting), before putting the washers and clips back on, I put a dab of polyurethane caulk over each badge pin, followed by the washer and clip. The rubber gasket trim under the air scoop at the base of the windshield should be removed. Remove the

*Continued on next page.....*

## PETER McLAUGHLIN'S 96 BODYWORK, continued

wipers first, and all their attendant rubber washers, nuts, etc. Then gently pry the scoop off with a screwdriver wrapped in a rag. The scoop is held in place with two "press fit" spring-type devices. Put it back in place for the paint job. Leave it there for the eight weeks before replacing the rubber trim, and wax underneath it first. Mask the thread on the wiper shafts so they don't get painted. Since you probably took out your door windows to work on the doors, that was a good time to remove the rubber window seals. If they are in very good condition, then remove them very carefully, as they are easy to tear. If they are at all cracked or weathered, replace them.

If your front windshield has been leaking (as they often do), now might be a great time to consider replacing the gasket. Leave it off for the paint shop and then drive it directly to the glass shop after the paint job, new Saab gasket in hand. If you can afford to replace the rear window gasket, then do that one too. I didn't do either, and the windows were the only thing on the car the paint shop had to mask, with the exception of the trunk lock, which I suppose I could have removed also.

By now you probably have quite a little collection of rubber parts. First wash them with a toothbrush and some Amorall cleaner. Then lay a garbage bag on a flat surface, and create a trough with a few long strips of wood. Spray everything with Amorall treatment, and let it soak in for as long as you like. Every day or so I visited my rubber collection and either sprayed it some more, or used the excess Armorall with a small brush.

The screws that fastened the trunk handle never seemed to hold all that well, so I replaced them with 1/4-20 cap bolts. You will have to enlarge all the holes to 9/32" to do this. The rubber washers between the handle and the trunk can be replaced with some nice ones I found in the plumbing section of a good hardware store.

"Extend" rust treatment: This stuff is sold by the Duro division of Loctite Co. It turns existing rust into an inert black substance, and coats everything with a polymer. I've noticed the Ziebart people now offer a rust treatment for used cars, and I bet that this is what they're using. Loctite claims it lasts for three to five years. It can be painted over and should be. It is expensive in small four ounce containers, but it is available in larger bottles.

"Tabco" fenders: They advertize in the back of Road & Track, etc. They used to offer 17 different body parts for the 96, but they have discontinued all but the fenders. They are not as heavy as the originals, but do the job fine and look quite good.

A word of caution. When removing paint from fenders, doors, etc., do not use a 24 grit sanding disc like I did. I can now see a fine pattern of swirl marks on all the parts I did. Either use a finer grit or use chemicals. You can take the parts to a paint stripper like Redi-Strip, but they are expensive.

Addendum: After going over my copy of my bodywork article, I realized it sounded like an ad for Maaco. I probably should have taken Andy Fedrowski's advice and used Imron. Even after five months and a wax job, the Maaco paint seems easily damaged by bird droppings, even when they're washed off the same day. Also the paint seems very

thin, although the coverage is opaque and even. It scratches and bruises easily. In spite of their fancy spray booth and oven facilities, they still managed to get a lot of dust and foreign matter under the paint. I've been told that all Maaco's are not created equal, being a franchise, so it would probably pay to shop around, as with any body/paint shop for that matter.

My guess is they make most of their money on body work, and they don't have a lot of sympathy for "straight paint" purchasers. My impressions were born out with people like Jon Petersen of Petersen-Frew Automotive. Jon said his first such experience as a lesson in naivete, thinking, "Gee whiz, I put all my heart and soul into this prep work, I hope they see a kindred body worker in me and give this job their professional best." Fat chance. My advice at this point is that if you've never done body work before, allow an extra hundred or two hundred dollars in your budget to let the body shop go over the car to really smooth out those tiny little dings and nicks that stand out like a sore thumb under a coat of gloss paint. There was a great three-part series in the May-June-July Road & Track issues about restoring old sports cars that I highly recommend. Good Luck

Peter McLaughlin, Evanston, IL

## EARLY 99 RUBBER BUMPERS WILL FIT 95/96

Early-type 99 rubber front bumpers are exactly the right shape for the front of 95/96's. By hacking the inner brackets off the 99 bumper and welding a stud on each side at those points, then cutting down the other set of brackets to easily clear the leading edges of the fenders the 99 bumper will fit right on. Using the cut off brackets you can fashion an extension of the outer brackets down to the original outer anchor points.

My own 95 now has 99 bumpers and rectangular European headlights. Note: the 99 rear bumper can fit the rear of 95's exactly, only separate side extensions are non-U.S. Also you must remove all plastic parts prior to welding.

92 Model--A beautiful die cast scale model of a 1952 Saab 92 is just out from Somerville models in England. Also, the same high detail model in Monte Carlo trim. About \$30 including postage via credit cards. Contact me for address.

Robert Allen, 114 Kimberly Rd.  
Hamden, CT 06518

## '72 99 NEEDS DISTRIBUTOR BUSHING MADE

My '72 99 developed a problem; it seemed impossible to gap the points properly to achieve a decent idle and performance. I had my choice of rough idle, or dying at idle, with suitable middle-to-high rpm performance--or good idle with lousy middle-to-high rpm performance, with cutting out problems. Finally after various ideas failed to cure it (checking vacuum advance, freeing up sticky distributor parts, etc,) it occurred to me that there was a great deal of play in the top of the distributor shaft. My local ace Saab mechanic, Dani, concurred, and set out to replace the upper bushing.

According to him, the distributor I had did not have an upper bushing (like most) and so he machined one. The car has run smooth and perfect for one year now, better than the day I bought it four years ago. Maybe this will help others.

Lawson Smith, Fayetteville, NY

## ANOTHER CURE FOR TURBO ENGINE HESITATION

Regarding Bill Atherholt's letter (Oct. '83, p. 7) about engine stalling and hesitation on his '81 Turbo, I think I may have an answer. I have an '82 Turbo and experienced similar difficulties during hot weather and particularly when using the A/C. This problem was diagnosed by my dealer as being a cracked fuel distributor gasket. This crack allowed hot air to vaporize fuel resulting in a form of vapor lock. I had the gasket replaced and have not experienced any problems since.

**Other Problems:** I also seem to have a fuel gauge problem. It seems that my gauge was faulty and was replaced. Now the needle jumps as much as half an inch when I hit a bump. The dealer has said that the fluctuation is normal. Has anyone else had similar problems? Alos I've been thinking of replacing my 85 mph speedometer for a 135 mph model. Can anyone who has done this pass along some information? Parts dealers, cost, ease of installation? etc. Thanks, I love the Newsletter.

Mike Zulich, Riverdale, NY

## POSSIBILITIES FOR 99 HEADLINER REPAIRS

I see that R. Lynn Warren (Aug. '83, p. 4) is having a problem with his '73 headliner. To repair the lining is difficult. Many adhesives react with those which are impregnated in the fiberglass moulding of the original part. I reached a solution for my own headlining on a '74 model which has proven reasonably effective. I switched to a vinyl covering and flued it to the headlining with carpet adhesive. The fit is not perfect, but the vinyl does not sag at all.

Another possibility is to glue some sort of fabric to a thin sheet of polyurethane foam with 3M spray adhesive. Then apply outdoor carpet adhesive for polyurethane-backed carpet to the headliner and affix the combined material/foam to the fiberglass shell following the instructions on the adhesive can.

Needless to say the old material must be thoroughly rubbed off of the fiberglass and care must be taken to prevent inhalation of fumes from any of the glues.

Ken Keown, Salt Lake City, UT

**SOUTHWEST LITTLE CAR SHOW**-- The Heinkel-Messerschmitt-Isetta Club presents the Southwest U.S. 4th Annual Unique Little Car Show and Swap Meet, Feb. 10-11-12 in Tucson, AZ. This is a get together for, but not restricted to, owners and enthusiasts of all little cars of about 1,000 cc or less. For more information, contact Louis Hudgin, 950 E. Hampton St., Tucson, AZ 85719, 602-624-7986.



ROUTE 1, BOX 19D  
RUCKERSVILLE, VA. 22968  
**SAAB PARTS & SERVICE**  
New & Used Parts at Reasonable Prices  
**TRANSMISSION & ENGINE REBUILDS**  
Our Specialty  
804-985-7924, Mon-Fri 8:00-6:00  
Visa/Master Card

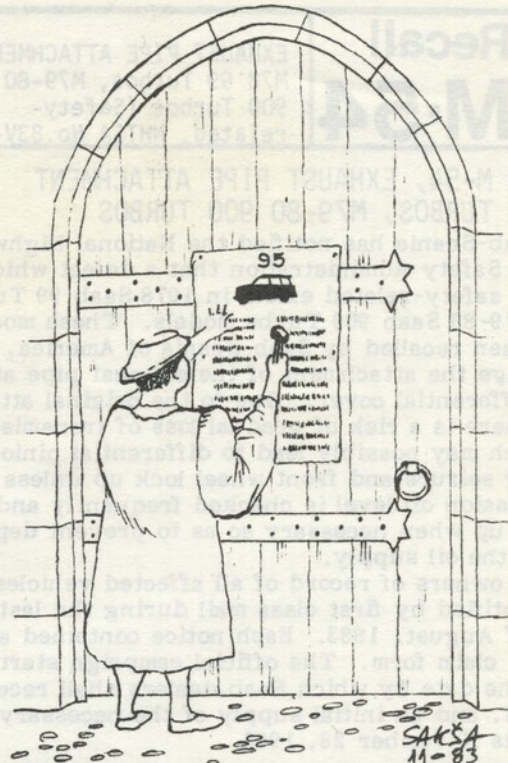

Martin Luther nailing his 95 theses on the church door. (by Andy Saksa)

## CHEAP FIX FOR BROKEN TURBO THROTTLE CABLE

Last month I had the misfortune of a broken throttle cable on my '79 Turbo. I had remembered in a previous issue of a similar incident

Last month I had the misfortune to have a broken throttle cable on my '79 Turbo. I remembered a similar problem in a previous issue where the member used a piece of picture frame wire, but it was not braided enough for the original Saab cable. Looking at my son's 10-speed bike, I noticed that the brake cable is almost identical.

It is best to run the cable from the engine compartment through to the accelerator pedal. For a stop on the cable I used a #7 lead split-shot sinker that works very well. Just make sure it is crimped tight. At a cost of \$1.50 for the bike cable and 55¢ for the lead, this makes a very inexpensive repair.

I have been getting the Newsletter for the past three years and it has really been a lot of help. Keep up the good work.

Richard McKinley, Garden City, MI

## Performance Cars, Ltd

**SAAB**  
SPECIALISTS FOR  
OVER 14 YEARS

9916 JEFFERSON AVE., NEWPORT NEWS, VA 23605

★ **EUROPEAN RALLY HEADLIGHTS**  
for all 900's. **\$225.00** pair

★ **NEW 2 LITRE BARE CYLINDER HEADS.** **\$450.00**

CALL OUR TOLL FREE ORDER 1-800-446-8958  
FOR A FREE COPY OF OUR 7th EDITION SAAB  
WHOLESALE PARTS CATALOG AND FALL SALE  
FLYER.

VISA MC  
Va. only (804) 596-3700

	<b>Recall</b> <b>M-54</b>	EXHAUST PIPE ATTACHMENT M78 99 Turbos, M79-80 900 Turbos (Safety- related, NHTSA No.83V-068)
	RECALL M-54, EXHAUST PIPE ATTACHMENT M78 99 TURBOS, M79-80 900 TURBOS	

**RECALL M-54, EXHAUST PIPE ATTACHMENT  
M78 99 TURBOS, M79-80 900 TURBOS**

Saab-Scania has notified the National Highway Traffic Safety Administration that a defect which may be safety-related exists in 1978 Saab 99 Turbo and 1979-80 Saab 900 Turbo models. These models have been recalled by Saab-Scania of America, Inc. to change the attachment of the exhaust pipe at the rear differential cover. Due to the original attachment there is a risk of gradual loss of transmission oil which may possibly lead to differential pinion bearing seizure and front wheel lock up unless the transmission oil level is checked frequently and topped up when necessary so as to prevent depletion of the oil supply.

All owners of record of all affected vehicles were notified by first class mail during the last week of August, 1983. Each notice contained a letter and claim form. The official campaign starting date, the date by which Saab dealers shall receive this S.I. and an initial supply of the necessary parts, is November 28, 1983.

**Modification Parts:**

99 Turbos: Exhaust pipe attachment kit 88-17-363.

900 Turbos: Exhaust pipe attachment kit 88-17-371.

**Repair Instructions:**

1. Drain transmission oil into a clean container. Oil will be re-used.
2. Remove the exhaust pipe mounting bracket.
3. Remove differential cover and replace the gasket. Replace the two studs that mounted the bracket with the two bolts (p/n 80-82-935) from repair kit.
4. Fit the new bracket (p/n 75-14-151 for 99 or 75-14-169 for 900) to the right side bearing housing of the inner driver (see drawings). Replace the three bolts that mount the new bracket with the lock plate (p/n 75-14-631) and three longer bolts (p/n 80-82-992). Torque the new bolts to 20-25 NM (15-18 ft. lbs.) and bend the lock tabs over the bolt heads.
5. Attach the exhaust pipe to mounting bracket with U-bolt (p/n 93-17-058) and nuts (p/n 79-67-953). NOTE: The exhaust pipe must not come in contact with the undercarriage of the car. Correct if necessary.
6. Re-fill the oil and top up if necessary with the appropriate oil (SAE 10W-30 motor oil or SAE EP-75 API GL-4 or -5).

*Ed. Note: For those few who may not have received the recall notice letter, it also states:*  
 "If you are the owner of a 1978-80 Saab Turbo which has experienced a differential pinion bearing failure due to lack of lubrication as a consequence of defective exhaust pipe attachment, you may (emphasis added) qualify for reimbursement of the amount you paid to have this particular failure repaired. CONSIDERATION FOR REPAIRS WHICH ARE NOT RELATED TO THIS DEFECT WILL NOT BE GIVEN. ALSO, PAST DIFFERENTIAL COVER GASKET REPLACEMENTS WILL NOT BE REIM-

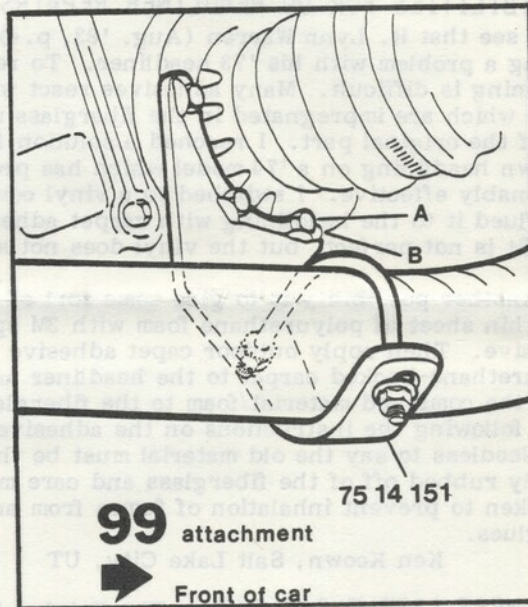
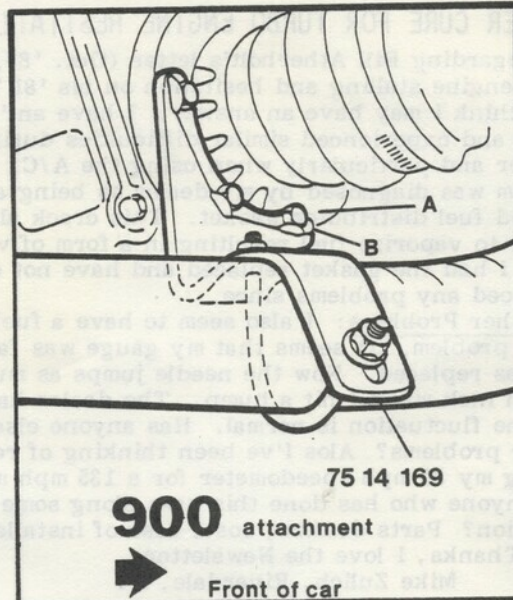

- A.** New bolts (3), 80-82-992  
TORQUE TO 20-25Nm (15-18 ft.lbs.)
- B.** Lock Plate 75-14-631  
BEND TABS AGAINST BOLT HEADS

**BURSED.** In order to be eligible for consideration, you must document the circumstances of the failure in letter form and include the vehicle identification number, repair shop name, date of repair and price paid for parts and labor. The letter along with a copy of the repair order should be sent to Saab-Scania of America, Inc., PO Box 697, Orange, CT 06477, Attention: M. Wickwire."

The Club thanks Mr. Daniel L. David, Manager of Technical Services at Saab-Scania of America, and Mr. Robert J. Sinclair, President of Saab-Scania of America, for continuing to provide Saab Service Information bulletins.

# SAAB SERVICE TIPS

## SAAB SERVICE TIPS--SEPTEMBER 1983

Captain's chair style armrests are available on the aftermarket which mount on the inboard side of Saab front seats. Saab-Scania of America, Inc. cautions its dealers that installing this accessory or making any other unapproved modifications to Saab seats may adversely affect the strength of the seat and/or compliance with Federal Safety Standards. Additionally, we accept no liability for any inconvenience this may cause as regards the operation of the gear shift lever and seat belt buckle release.

Rough running or fuel cut-out on hot days may be traced to the fit of the feeder pump to the main pump's enclosure. The "O"-ring that seals the feeder pump to the main pump assembly must not be cut or pinched on installation. This applies to the new fuel delivery system (see S.I. 06/83-635) introduced during 1983 production.

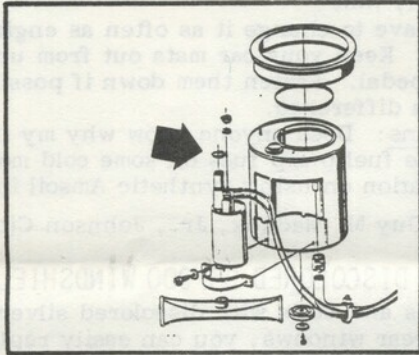

Oil leaks at timing cover oil galley plug can be corrected without replacing the cover or removing the engine by following this procedure (H-engines only):

- Remove the leaking oil galley plug using a punch or similar removal device.
- Thoroughly clean the galley plug area of all oil and debris.
- Apply Loctite Sleeve Retainer #2726 to a new galley plug (p/n 81-23-176) and install.
- Allow the repair to set-up for at least four hours. Check your oil level and verify the repair.

NOTE: Better access to the cover may be obtained by moving the AC compressor to one side. It is not necessary to discharge the AC system.

The black rubber cargo mats (p/n 02-11-102) available from Saab as an accessory can also reduce road noise somewhat, particularly with the rear seat folded down. These mats fit all 900 models and can be trimmed to fit 99 hatchback models.



## NEW FUSE PANEL AND FUSE TYPE, 1984 MODELS

Saab Service Info. 09/83-640: Beginning with M84, a new fuse panel and fuse type have been introduced. The new fuse is of the "blade" type.

All fuses are in color coded transparent plastic so the fuse element is protected from oxidation yet is visible through the body. A fuse that has been subjected to current overload will have a broken element (fuse must be removed to check condition). Fuses may also be checked with a test light (circuit switched on) at the two openings at the top of the fuse.

A fuse removal tool is supplied with each car and is located in the fuse panel itself between the fuses and the relays. Use this tool to remove a fuse. When replacing the fuse, be sure that it is seated firmly into its slot.

NOTE! 1. Do not attempt to repair a broken fuse. 2. Do not replace a blown fuse with one of higher amperage. Check for the source of the problem.

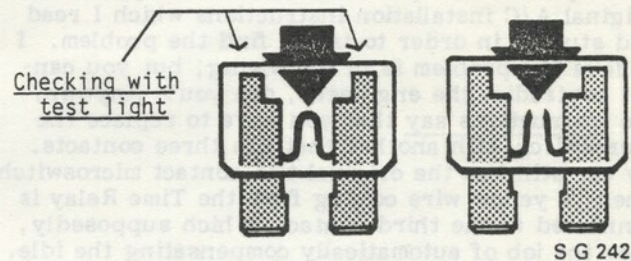

Ampere Rating	Color	Saab P/N
7.5A	Brown	*02 61 461
10A	Red	79 74 637
15A	Light Blue	79 74 645
20A	Yellow	79 74 652
25A	White	79 74 660
30A	Light Green	79 74 678

\*This fuse is found at the back of the Saab/Clarion radio.

## CHECKING DISTRIBUTOR CONNECTION, NEW CARS

If an engine is suddenly cutting out or is difficult to start, check the wire connector to the ignition distributor to ensure that it makes good contact.

Unplug the connector at the distributor and re-connect, making sure that the connector bottoms and is locked into position.

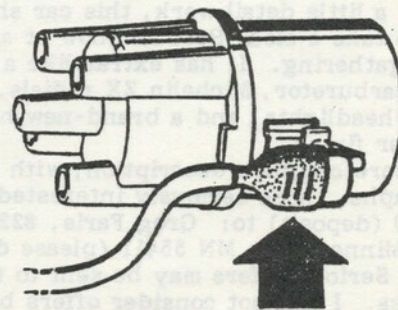

### A/C FAST IDLE SOLENOID EXPERIENCES & MORE

Regarding Mac Steiger's letter in the October Newsletter (p. 8), my '79 900 Turbo was delivered with the same problem, that is, the idle compensation valve will not increase the idle automatically, as it is supposed to do. I removed the Time Relay, so that the compressor will not cycle on and off. It will always be "on," as long as the selector switch is positioned in the two A/C positions (or if you have updated the system with a push-push dash switch as in the 1980's, as long as the A/C switch is pushed "on."

According to a factory trained mechanic, you are supposed to rev the engine until it "compensates," with the compressor "on." Not just revving it; but short throttle revs. This problem is "normal" in the '79 and '80 models. As he said, "you have to live with it." But once the Time Relay is removed, you'll only have to turn on the A/C, do a few short revs, or a long one above 3,500 rpms, and the idling will hold.

Import Motors provided me with a copy of the original A/C installation instructions which I read and studied in order to try to find the problem. I believe the problem is in the wiring, but you cannot contradict the engineers, can you? Anyway, the instructions say that you have to replace the Microswitch with another that has three contacts. My car still has the original two-contact microswitch. Then, a yellow wire coming from the Time Relay is connected to the third contact, which supposedly, does the job of automatically compensating the idle.

However, in the schematic diagram of the instructions, it firmly says, "do not use yellow wire or three-contact microswitch in cars with Lambda." Well, my car has Lambda, and that is probably why the A/C shop did not install the three-contact microswitch, which is listed as "included" with the parts kit list.

After almost four years of trying to resolve the "elusive idling syndrome," I gave up and resigned myself to taking the mechanics advice, "Rev it up."

**Cooling System Drainage:** Here's a small contribution to those who still have problems draining the cooling system of all the old coolant, on late model two liter engines. There are two drain plugs behind the manifold, one above the other vertically. One is a 1 1/2 inch bolt/plug, and the one below it is a 19mm bolt/plug. The removal of the 19mm one will drain the block completely. The removal of the "monster" plug will drain the head and part of the block only.

**96 FOR SALE--** This 96 V-4--which I consider to be one of the finest 96's around--will be offered for sale to the highest bidder at the end of this year. With a little detail work, this car should be ready to take a clear Best In Show at any Saab Club gathering. It has extras like a Weber 34 ICH carburetor, Michelin ZX radials, Cibie Z-beam headlights, and a brand-new high-gloss lacquer finish.

For a more complete description, with color photographs, those seriously interested may send \$10,00 (deposit) to: Greg Faris, 822 Penn Ave. No., Minneapolis, MN 55411 (please do not telephone) Serious offers may be sent to the same address. I will not consider offers below \$3,500.

A report on my own "on demand" seat heater re-wiring (April '83, p. 3): it continues to work perfectly. Recently, temperatures have dropped to the 30's here, and very cold inside the car. I turn on the engine and seat heaters, and after the engine has warmed up, I turn off the seats and use the regular heating system.

Josie Maymon, Nashville, TN

### TIPS FOR HELP WITH STIFF SHIFTING 900's

**Tip #1:** Pull up the rubber boot around the shift lever, making sure the shifter is in neutral. Screw out the three Pozi-drive screws that hold the shifter in place. Pull shifter out of console and spread light grease over all mating parts in the console and shifter. After heavy greasing, reassemble the shifter to console. This should help noticeably.

**Tip #2:** If anyone is familiar with Amsoil, their their "SF" grade 10W-40 synthetic oil works wonders in the transmission. The manual calls for three quarts of "SE" grade of 10W-30. The SF grade supersedes the SE grade and the synthetic 10W-40 seems light enough to work well in the transmission. The price of \$5.95 a quart seems expensive, but you probably won't

you don't have to change it as often as engine oil.

**Tip #3:** Keep your car mats out from under the clutch pedal. Fasten them down if possible, it does make a difference.

**Questions:** Does anyone know why my '78 EMS will blow the fuel pump fuses on some cold mornings? Any information on using synthetic Amsoil in Turbo's?

Guy M. Maddox, Jr., Johnson City, TN

### REPLACING DISCOLORED 99/900 WINDSHIELD TRIM

For 99's and 900's with discolored silver trim on front and rear windows, you can easily replace it with black (turbo) trim. Make the wire part of the installing tool shown in the shop manual out of 2mm welding rod (flux removed). Instead of using the fancy handle from Saab, just use a Vise-grips to hold the ends of the tool. (see illustration)

Remove the old trim, spray the groove in the rubber seal with Armor-all and use the tool to install the new trim pieces. It is really quite easy. The black trim pieces for the front window only of a '79 900GLi is about \$40.

Toby M. Turpin, Silver Spring, MD

### Bertone Auto Body

*The SAAB Specialists*

- Metal Finish
- Lead Work
- Factory Paint (colour match guarantee)
- Alarm Systems
- Quality Stereos

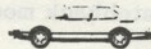

**We install High Performance equipment such as:**

- Intercoolers
- Turbo Savers
- Sway Bars
- Springs
- Location:**  
1101 Olympic Boulevard  
Santa Monica, CA 90404

For appointment call today at:  
**(213) 450-5506**

*10% Discount to the members of the club.*



# PARTS MART



## CLASSIFIED AD RATES

Ads offering parts or Saabs for sale or wanted at prices under \$200 are FREE to members and non-members. 25-word limit, plus name and address. Ads listing prices of \$201 to \$900, enclose \$2. Ads listing prices \$901 to \$2000, enclose \$5. \$2001 and up, enclose \$10. All ads without a price listed, enclose \$10.

Commercial ads, \$10 per column inch, two-inch maximum. We will delete all unnecessary superlatives and abbreviate where possible. Please enclose sufficient funds with ad copy; we will *not* bill.

## CLASSIFIED AD DEADLINE

The Classified Ad deadline for the January '84 Newsletter will be Jan. 2. The deadline for the February issue will be Feb. 1.

## 95's and 96's FOR SALE

1960 93, complete, runs well; floor rusted but repairable. with '58 parts car: \$500. Al Krebs, PO Box 72, Holicong, PA 18928, 215-794-7098.

1964 96, 4 spd., engine out and apart, body very good, newer-style u-joints, etc.: \$200. Chris Morgan, 416 Perry St., Prescott, AZ 86301, 602-776-0627 home, 602-445-5801 work.

1967 two-stroke, oil-injected 96, 10,000 on rebuilt eng., newly rebt. trans. w/ good freewheel; good body, little rust: \$750; Also two good V-4 engines, trans., shocks, windshield & many more parts, make offer. Carl Georgeanni, Burlington, NJ 609-387-2042.

1968 96, trans. knocks, bad engine, good glass, hood, trunk, etc.: \$150; Also 1967 96, runs well, new valve job, good rubber, exhaust, front drivers rusty doors: \$500. Larry Melinsky, Box 186, Howard Lake, MN 55349, 612-286-5298.

1967 two-stroke 96, 108,000 miles, completely rebt engine at 80,000; rebt trans. at 70,000; minor rust & rear quarter dent: \$450. Coleman Bynum, 9 Grand St., Cornwall, NY 12518, 914-534-7843.

1969 95 wagon; orig. blue paint; exc. cond., rebt trans., radials, many new eng. parts; lots of room; great on the highway: \$2000 obo. Peter Spelman, 213-399-3979, Santa Monica, CA.

1970 96 V-4, only 89,000 mi.; blue int. & ext.; completely new clutch system, new radiator, new brakes new valve job & tune-up, plus sun-roof; exc. rust-free cond.: \$1700. Marc A. Frank, 1528 49th St. #3K, Brooklyn, NY 11219, 212-438-2022 anytime.

1971 96 V-4, blue, floor rusted out, good engine, seized trans., over 110,000 mi, but int. good; a parts car: \$195. Marc Frank, see address above.

## 95's and 96's FOR SALE, continued

1972 96 V-4, only 94,000 mi., tan int. & ext.; garaged, no rust; smooth body, new clutch, superb cond.: \$1800. Marc Frank, see address above.

1971 95 wagon, blue, strong V-4, 73,000 mi. less than 4000 on rbtl trans., new clutch, exh. sys. & rear tires, int. clean, no rot body primed & needs paint: \$1650. Mark Vander Berg, Boston, MA 617-335-4585.

1972 96, 98,000 mi., good cond., minor rust; eng. rebt at 91,000; trans. at 70,000, work done at Midwest Vee in St. Paul: \$1000 obo. Bob Sipkins, Mpls 612-339-5581 (office)

1973 95, dk. grn., 106,000 mi., eng. & trans. rebt paint & bodywork in excep. cond.: \$1950. Tony Atkin, 372 Lorraine Rd, Glen Ellyn, IL 60137, 312-469-1569.

## 95, 96 and SONETT PARTS FOR SALE

1966 96 hood, exc.: \$25; '67 Sonett hood: \$75; good '67 Sonett body & hood: \$500; 96 wheels: \$5 ea. Jeff Krebs, PO Box 72, Holicong, PA 18928, 215-794-7098.

Two rebuilt heads for '69 V-4, new valves, guides, seals, springs, run for less than two hours: \$200 for both. Andrew Sabersky, PO Box 2483, Santa Cruz, CA 95065, 408-475-2697.

Air conditioner, complete from '72 95: \$50; 95 lever shocks L & R, used: \$25 pair. Jim Barnes, 402 Oak St., Missoula, MT 59801, 406-543-8740.

Complete rear body from '73 Sonett, undamaged: \$300; set of doors: \$125; late model distributor, rebushed & recurved to '69 specs: \$50; black eng. w/ extra parts: \$150. Al Sorokach, RR5 Box 333, Elro Drive East, Oak Ridge, NJ 07438, 201-697-7321/5228

V-4 parts--1498 blue motor: \$150, can be driven; dealer's 2-stroke parts book: \$49.95. Bob Allen, 114 Kimberly Rd, Hamden, CT 06518, 203-248-8798.

Rear clip from '68 Sonett V-4, complete from door striker back (no window) \$190 obo. John Mahey, 351 N. 73rd St., Harrisburg, PA 17111 717-564-1636

More classified ads on next page.....

## SAAB

ODBERG-RYAN

LINCOLN-MERCURY SAAB

2224 W. Superior St., Duluth, MN 55806

Phone 218-722-3317

Minn. Only Toll Free Parts Line 800-232-0051

Parts orders shipped same day UPS, up to 5 pm

95, 96, and SONETT PARTS FOR SALE, cont'd

Set of four wheels w/lug nuts, centers ok, M/S radials mounted: \$300; seats, pair: \$110; steering wheel w/button: \$55; all from '74 Sonett--Also from '74 Sonett: engine: \$110; trans.: \$165; headlight buckets & linkage: \$50; steering rack: \$30 & more. Also nice assortment of Sonett spares, brake & clutch parts, switches, bulbs, instruments, suspension, boxes of other goodies: \$200 the lot. Walt Arnold, 412-530-6190.

Sonett trailer, specially designed & built for Sonett, tilt bed, just drive all four wheels off the ground, 3000 lb. capacity: \$650. Walt Arnold, 412-530-6190.

95, 96, and SONETT WANTEDS

Wanted: 92-97 sales literature, posters, memorabilia etc.; Also wanted correspondence with other Saab literature collectors. Bob Allen, 114 Kimberly Rd, Hamden, CT 06518.

Wanted: 15 lug bolts for Sonett III mag wheels, w/washers; Also '68-69 Sonett Bonnet, 2 barrell V-4 manifold. John Mahey, 351 N. 73rd St., Harrisburg PA 17111, 717-564-1636.

Wanted: Close ratio gear set for V-4 trans.; Also two-barrell manifold for V-4. Bruce Alexander, 4719 Pitt, Duluth, MN 55804, 218-525-2884.

Wanted: like new rear bumper for '66 96 & bumperettes: \$25?; '66 like new rear view mirror for door; 3 cyl. 2-groove a/c pulley; '66 factory orig. brown upholstery for driver's seat w/ gray vinyl. Al Krebs, PO Box 72, Holicong, PA 18028.

99's and 900's FOR SALE

1974 99LE 2 dr., blown engine, rblt 4 spd, new clutch, radials, radiator; exc. So. Cal. body: \$650 obo. Also have two sets of '69 & later 96 front buckets, good cond.: \$20 ea. Mark Rheude, 781 E. Swanee Ln., Covina, CA 91723, 213-332-0046.

1978 99GLE, 5 dr, 4 spd with air, white w/ red int. factory mags, am-fm stereo 8 track, 120,000 mi., car looks new in & out: \$4000. Al Krebs, PO Box 72 Holicong, PA 18928, 215-794-7098.

1978 Turbo, 3 dr, maroon, 4 spd, 54,000, 4 new Pirelli P-6's, new battery, ansa exh., quartz headlights, custom & stock airdams, exc. cond.: \$5900 Frank Parella, Middletown, NY, 914-343-7474 days, 914-342-3561 eve's & weekends.

1979 GL 3 dr., 4 spd, red/gray cloth, sunroof, 52,000 highway miles, purchased new in 1980, new front tires, brakes, muffler; garaged Wisc. car, will deliver. Roger Kroeger, PO Box 343, Neptune, NJ 07753, 212-496-8604.

1980 900GH, charlotte brown, 36,000, Blaupunkt am-fm cass, sport console w/ VDO gauge trio, new factory air this year, rustproofed & more; exc. cond \$7500. Ed Anderson, 200 Glen Addie, Belleville, IL 62221, 618-235-5444.

1982 900 Turbo, black, 3 dr., fully equipped with rear window shade, Saab carpets, etc. exc. cond. \$11,000 obo. Paul Dukehart, 81 W. Green St, Westminster, MD 21157, 301-848-7207 home, 301-944-2273 work.

99's and 900's FOR SALE, continued

1984 Turbo, 3 door, admiral blue, 500 miles: \$16,750 Carl Elliott, 404-998-2377, Roswell, GA

99 and 900 PARTS FOR SALE

Parting out '75 99LE, 4 dr., completely rblt auto. trans: \$500; rblt torque converter: \$100; green cloth interior: \$175; doors: \$50 ea; trunk: \$50; bumpers: \$35; am-fm stereo 8 track CB: \$75; eng. & intstrument parts avail. Jeff Krebs, PO Box 72, Holicong, PA 18928, 215-794-7098.

Five-speed trans. parts from an '80 900 Turbo, damaged case, broken pinion gear, everything else good \$125. Marc Frank, 1528 49th St, #3K, Brooklyn, NY 11219, 212-438-2022.

Pair headlamp bezels to fit '79-82 900's: \$12; A/C time relay for '79-80 900's: \$6; Locking gas cap for '79-80: \$2; spare gas can, never used, round-type: \$15, prices incl. shipping. J. Maymon, 615-646-1305 eve's.

Front bumper, '83 900, 2 inch blem mark, otherwise good: \$175 (incl. shipping) Eddy Borchert, 2004 Cloverfield Ln #14, Charleston, WV 25312, 304-747-1860, 24 hours.

Set of radiator hoses for '74 99, will fit other model years?, new, paid \$50, will sell for \$20. Jerry Plotkin, 1371 Monomoy, Aurora, IL 60506, 312-892-3973.

EMS wheels: \$50 ea; '77 steering wheel: \$20; two CIS injectors (new) \$15 ea; '75 dash cluster w/ 120 mph speedo: \$30; starter solenoid, new: \$35. prices plus shipping. Bill Grace, 535 Silver Spring Cir., Colo. Springs, CO 80919, 303-598-7983.

New OEM alloy wheels from new 900S: \$100 ea. Bruce Berlinger, 6 Baysite Ln., Falmouth, ME 04105, 207-781-2833.

Four Saab allowy wheels (135TRX390FH) with hub caps & lugs--perfect cond.: \$165 plus UPS. C.J. Theobald, 227 Fallon Cir. SW, Port Charlotte, FL 33948, 813-625-1113.

"Convenience spare" fire & wheel from 1980 900, never used: \$49 obo, plus ship. Nigel Jennings, 7146 Atheling Way, Canoga Park, CA 91307, 213-700-5947 days, 213-340-6256 eve's & weekends.

Factory service manual for 99 covering '75 to '80: \$30; Steering wheel for 99GL, '77: \$30. W.C. Redding, 813-792-5169.

EMS mag wheel, \$25 plus UPS. Bob Mitchell, 609-641-4460.

'73 99 hubcaps, four: \$20. G. Williams, 603-436-4636.

Concord HP-122 indash cass. receiver, Dolby NR, tape equalization, match phase tape head, digital scan tuner with 10 channel memory & scanning. Builtin preamp, never used. will fit any 900: \$255 Mark Diels, 944 Fond du Lac Ave, Sheboygan Falls, WI 53085, 414-457-4441 8-5, 414-467-2204 after 5.

99 hood in exc. cond.: \$100; trunk lid for 99 2 dr w/ lock & key: \$60; new ign. switch & keys for '78: \$30; high mileage eng. & trans out of '70 99, free for the taking. Bob Dixon, 2030 Clarkson Rd, Chesterfield, MO 63017, 314-532-0806.

## 99 and 900 PARTS FOR SALE, continued

Four Ice-Snow Roadhandlers, 165SR15, mounted on steel wheels, less than 15,000 mi.: \$140; Four 99 shocks, little used: \$40, four 99 hub caps: \$20. Bob Griffith, Sr., Hazelcrest, IL 60420 312-957-0521

Parting out '74 4 door 99LE, professionally rebt auto. trans: \$350; Power steering, fuel injection, engine parts, rust free body parts, etc. Tom Reinse, 12110 Georgian Tr, St. Louis, MO, 63131, 314-965-6278.

## 99 and 900 WANTEDS

Wanted: good left front caliper for '72 99 and radio pod for '78 w/factory AC; also glove box lock w/ key for '78. Bob Dixon, 2030 Clarkson Rd, Chesterfield, MO 63017, 314-532-0806.

Wanted: Hub caps to regular '82-83 900 steel wheels. Eddy Borchert, 2004 Cloverfield Ln. #14, Charleston, WV 25312, 304-747-1860, 24 hours.

Wanted: One "Inca" alloy wheel for '80 900 Turbo. 317-253-9858 leave message or 317-259-1959.

Wanted: will pay up to \$35 for a good Saab factory service manual covering '76 and later models. Adrian Snare, Box 104, Eppers, PA 17319, 717-938-5207.

Wanted: set of Turbo or "S" wheels from '82-84 900, steering wheel hub impact support for '79-80 900. Chuck Vitali, 203-345-2959, Oak Ridge Dr, Haddam, CT 06438.

Need exhaust manifold for '73-74 2.0L (no cracks) will buy or trade for custom header for same. Brian Harris, Rt 8 Box 56, Abingdon, VA 24210, 703-628-3794.

Wanted: complete service manual, orig. or copy for '83 900S & Turbo. Bernard Shapiro, 78 Livingston St., Brooklyn, NY 11201, 212-403-9696.

**INFORMATION WANTED:** Any information on putting a Subaru engine and transmission into a Sonett III. I would like to know what problems or successes were encountered. Call collect 515-282-0769 or write Alan Hoover, 400 W. Leach, Des Moines, IA 50315.

## **hakkapeliitta®**



## **NR09**

In tests made by the highly-respected Scandinavian car and technical journal "Vi bilagare" (We Car Owners), Hakkapeliitta NR09 snow tires outperformed Conti, Michelin, Gislaved, and others. Hakkapeliitta is by far the leading tire in Finland where winter driving is a way of life.

These are the tires that were so good their use was banned in PRO Rallies. Hakkapeliitta NR09 snows are now available from the Club in size 165SR15 for \$69 ea. incl. UPS, or \$260 for a set of four, UPS included. Contact Jeff Delahorne, 5805 Oneida Duluth, MN 55804, 218-525-3253.



*The Saab Club Rally Team, Jeff Delahorne and co-driver Bob Hansen starting a special stage outside of Houghton, MI in the Press On Regardless PRO Rally Nov. 4-6. (photo by Bruce Alexander)*

## ZENZ IS 2ND IN CLASS AT POR AS MIKKOLA WINS

A second day charge-by Erik Zenz of West Allis, WI took the Saab driver to second in Production Class at the Budweiser Press On Regardless PRO Rally in Michigan's Upper Peninsula Nov. 4-6, while 1983 World Rally Champion Hannu Mikkola won with ease driving for an ailing John Buffum in the Audi Quattro.

This year's POR saw a return to much rougher roads than used in the past few years, a fact that benefitted Zenz, as the Saab was able to keep running at speed while much of the Production Class competition either broke (AMC SX-4's) or were forced to slow way off the pace (Dodge Shelby Charger's). Erik made a run at first in class and fifth overall as series P-Class leader Steve Nowicki lost time when he went off the road at a spectator corner. Nowicki's Plymouth Arrow was pushed back onto the road by helpful fans and he hung on to win by slightly more than a minute.

Finishing tenth in Production and 15th overall in their first national PRO Rally were Jeff Delahorne and Bob Hansen in a '79 99. Saab Club members Rich Kushner and Jim Seiple suffered their first DNF of the year in an Open Class '76 EMS as they went off the road on Stage 9, one of the rougher roads used in the rally. Two other Saabs among the 40 cars that failed to finish were open class 99's of Dave Watkins/Jan Beveridge and Dick Fitzgerald/Jim Graves of Dallas, TX and Baton Rouge, LA respectively.

The next PRO Rally is the Sno\*Drift National PRO Rally December 2-4 in Grayling, MI.

## PITT. MEMBERS HELP SAABER IN DISTRESS

Two Club members from the Pittsburgh, PA area deserve a note of thanks. Stuck over Labor Day in Pittsburgh in need of a right front hub for my '73 96, I had a Newsletter with me that had the names and numbers of Rich Simpson and Tom Franko. Both were helpful in the extreme and most kind. Because of their assistance, I obtained the hub and was able to drive 300 miles home without incident.

Carl J. Tomaine, Jermyn, PA

November 1983



NOV./DEC. 1983

Address Correction Requested

c/o Jeff DeLborne  
5805 Onelda Street  
Duluth, MN 55804



BUICK RATE  
U.S. POSTAGE  
PAID  
PERMIT No. 1909



GO YUMP A  
WELL-BUILT  
SWEDE!



SAAB  
99

MORE CLUB T-SHIRTS AVAILABLE-- At long last we have more Jack Ashcraft-designed T-shirts available. The Turbo T-shirt is tan with dark blue ink while the 99 shirt is yellow with blue ink. Both are 50-50 Hanes, top quality shirts, in sizes M, L, & XL. The price is \$7.00 each plus \$2.00

per order for shipping. Orders shipped next day  
Mail.  
to clearly state size and style.